

MICHIGAN SCIENTIFIC CORPORATION

WHEEL FORCE TRANSDUCER MEASUREMENT SYSTEM



MODEL: LW-MC-3.5K

FOR MOTORCYCLES



MICHIGAN SCIENTIFIC
corporation

DECEMBER, 2013

REVISION 2.1

Technical Support

For technical support, contact Michigan Scientific Corporation.

Michigan Scientific Corporation

Milford, MI Location

321 E. Huron St.

Milford, MI 48381

ph: 248-685-3000

fax: 248-684-5406

Charlevoix, MI Location

8500 Ance Rd.

Charlevoix, MI 49720

ph: 231-547-5511

fax: 231-547-7070

<http://www.michsci.com/>

webinfo@michsci.com

Table of Contents

TECHNICAL SUPPORT	1
INTRODUCTION.....	4
SPECIFICATIONS	6
MASS OF COMPONENTS, TYPICAL.....	6
SYSTEM COMPONENTS	7
TRANSUCER	7
CT2-TEL ELECTRONICS.....	8
TELEMETRY STATOR	8
ADJUSTABLE TELEMETRY STATOR BRACKET.....	9
HUB ADAPTER	9
WHEEL ADAPTER.....	10
POWER CABLE	10
SIGNAL BREAKOUT BOX.....	11
ETHERNET CABLE	11
CAN BUS CABLE.....	12
TRANSUCER ID DONGLE.....	12
TELEMETRY ALIGNMENT SPACER.....	13
WFT AND TELEMETRY STATOR FREQUENCIES	13
ASSEMBLY INSTRUCTIONS	14
BEFORE ASSEMBLY	14
ASSEMBLY.....	14
TELEMETRY STATOR INSTALLATION	16
FINAL TRANSUCER INSTALLATION	18
CT2-TEL	19
INTRODUCTION	19
LIGHTS AND CONTROLS.....	20
<i>Power Switch</i>	20
<i>Autotune Button</i>	20
<i>Zero</i>	21
<i>Shunt</i>	21
<i>Mode</i>	21
<i>Zero Angle</i>	21
<i>Coordinates</i>	22
<i>Fault</i>	22
<i>Position</i>	22
<i>Indicator Lights</i>	23
<i>Connectors</i>	24

<i>Output Channels</i>	24
OUTPUT CHANNEL SENSITIVITIES.....	24
ZERO AND SHUNT CONTROL FUNCTION TABLE.....	25
OUTPUT CHANNEL; OFFSET, SENSITIVITY AND TRANSFORM FUNCTION TABLE.....	26
SYSTEM DELAY	26
POWER REQUIREMENTS.....	28
BALANCING – ZEROING	28
1. ZEROING ON THE HOIST	29
2. ROLLING ZERO ON THE ROAD.....	30
3. STATIONARY ZERO	30
VERIFYING THE ZERO PROCEDURE	31
FACTORY CALIBRATION	32
SHUNT CALIBRATION SEQUENCE.....	32
WEB PAGE SELECTABLE OPTIONS	33
CT2-TEL SERIAL NUMBER.....	35
DEFAULT COORDINATES ON POWER-UP	35
FULL SCALE VELOCITY	36
ANALOG OUTPUT RANGES.....	36
MEASUREMENT ORIGIN	37
TRANSDUCER ORIENTATION IN SIMULATOR USE.....	39
CHANGING WFT COORDINATE SYSTEM.....	40
CT2-TEL ETHERNET CONFIGURATION	41
STATIC VALUES.....	41
TRANSDUCER INFORMATION.....	43
CT2-TEL CAN BUS CONFIGURATION	43
<i>CAN Bus Termination</i>	45
CT2-TEL REMOTE CONTROL.....	47
UPDATING FIRMWARE IN CT2-TEL.....	48
TRANSDUCER OFFSET CHECK	49
CROSS-AXIS SENSITIVITY	50
WEATHERPROOFING	50
WHEEL OFFSET CONSIDERATIONS	50
SAMPLING FREQUENCY	50
UNDERSTANDING SAE COORDINATES	51
RIGHT HAND RULE COORDINATE SYSTEM (OPTIONAL)	53
WFT CHANNEL RECOVERY	54
TROUBLESHOOTING	56
APPENDIX 1	61
CT2 ANALOG <i>SIGNAL OUT</i> CONNECTOR PIN-OUT	61
CT2-TEL <i>POWER CABLE</i>	61
TRANSDUCER CALIBRATION QUICK REFERENCE SHEETS	62

Introduction

The Michigan Scientific Motorcycle Telemetry Wheel Force Transducer system is a 6-axes transducer that measures forces and moments on a vehicle wheel. It offers accurate measurement of force and moment inputs on a motorcycle hub, convenient Transducer interface box, and wireless data transmission.

The transducer mounts between the tire and vehicle hub. A modified wheel rim is used to adapt to the vehicles tire, and a hub adapter is used to mount it to the vehicle spindle. All forces and moments on the wheel must pass through the sensor before being transferred to the motorcycle hub.

Six independent strain gage bridges measure the forces and moments. The transducer is designed to have low cross talk between channels and to be insensitive to temperature change and magnetic fields.

A consequence of incorporating the sensing elements within the motorcycle's wheel is that the transducer's coordinate system (a.k.a. wheel coordinates) rotates with respect to the motorcycle's spindle. For those users interested in wheel loads per se this is fine. However, having the load data measured with respect to rotating wheel coordinates is not convenient for those users interested in the loads introduced into the motorcycle. It is instead preferred to have the load data with respect to spindle coordinates. To transform the wheel coordinate data into spindle coordinate data, angular position of the wheel with respect to the spindle must be known. A magnetic ring is mounted to the back the transducer and several precisely located Hall Effect sensors are mounted close to the magnet ring inside the Telemetry Stator. An Encoder Zero procedure needs to be done each time the system is moved to a new motorcycle so the Encoder has an angle position reference. The encoder provides angular position information needed for both the coordinate transformation and velocity calculations.

Coordinate transformation, supply power to the induction and the user interface is handled by the CT2-TEL electronics. A zero procedure automates the transducer-offset adjustment. Options allow the transducer to be used in both rotating or non-rotation modes and control bridge excitation. The user selects wheel location for the sensor and corrections will be made to keep the output in SAE coordinates. Error checking is in place to alert the user if the system is out of tolerance. Corrections are made for cross axis sensitivity. Finally, a shunt procedure calculates output sensitivities and allows the user to record shunt values. Signal outputs can be ± 10 volt

analog, via CAN bus, or Ethernet. Communication to the CT2 for setup is done through an Ethernet connection and an embedded web page.

Specifications

LW-MC-3.5K
6-Axis Wheel Force Transducer
Aluminum

Capacities

Full-scale Output	[Fx, Fz]	3,500 lb	15.6 kN
(Maximum Force Capacity)	[Fy] at Tire Patch	1,200 lb	5.3 kN
Full-scale Output	[Mx, Mz]	1,200 lb-ft	1.6 kN-m
(Maximum Torque Capacity)	[My]	2,500 lb-ft	3.4 kN-m

Other

Full Scale Output (before amplification)	1mV/V nominal
Sensor	4 arm strain gage bridges
Nonlinearity	< 0.5% of full-scale output
Hysteresis	< 0.5% of full-scale output
Cross Axis Sensitivity Before Correction	<4% of full-scale with amplifier
Radial Sensitivity Variation	<1% of radial load
Bridge Resistance	233 to 1400 ohm, axis dependent
Compensated Temperature Range	21 to 93 C (70 to 200 F)
Excitation Voltage	3.00 VDC
Insulation Resistance from Bridge to Case	Exceeds 1000 Mohm
Motorcycle Power Input Voltage	10 to 36 VDC

Mass of Components, Typical

Component	lbs	Kg
Wheel Load Transducer with telemetry and encoder ring	5.0	2.25
Telemetry Stator with Cable	2.0	0.9
CT2-TEL Electronics	4.0	1.8

System Components

The Wheel Load Measurement System is made up of multiple components.

Transducer



Backside of Transducer



Front side of Transducer

Six Axis Wheel Force Transducer has built-in RF Telemetry Transmitter, induction regulator, encoder ring, & secondary induction coil. The telemetry transmitter provides excitation and amplification to the strain gage bridges. It also contains the precision shunt calibration resistors with low temperature coefficients which insure good performance over all temperature ranges.

The Telemetry Transmitter frequency is set in the factory and must be used with a Telemetry Stator set at the same frequency.

CT2-TEL Electronics



CT2-TEL Electronics. The CT2-TEL contains the Induction Power Supply. The dimensions are 7.5in x 1.375in x 11.5in (191mm x 35mm x 292mm). See page 19 for operating instructions.

Telemetry Stator



The Telemetry Stator contains the RF Telemetry Receiver, Primary induction coil, and Hall Effect sensors. The RF Telemetry Receiver detects and processes the signals from the Telemetry Transmitter. These signals along with the encoder pulse signals are digitized and sent the CT2-TEL for signal processing. The frequency of each Telemetry Stator is programmed in the factory to match the RF frequency of the transmitter built-in to a particular WFT. The frequency of each Telemetry Stator can be changed by using the CT2-TEL webpage.

Adjustable Telemetry Stator Bracket



This adjustable bracket can be used to mount the Telemetry Stator. It was designed to have a lot of adjustment to help with the alignment and mounting of the Telemetry Stator.

Hub Adapter

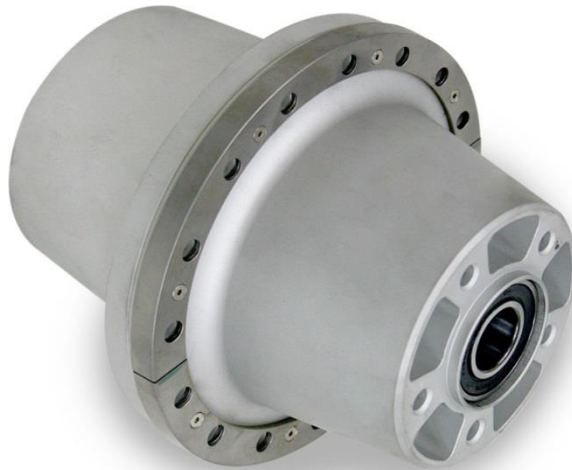

The hub adapter mates to the smaller bolt circle of the transducer and is designed to match the offset of the production wheel. If used in conjunction with modified production rims, a new hub adapter is required for each wheel offset and bolt circles.

Wheel Adapter



Wheel adapters or modified wheel rims can either be machined out of a billet or made from a production rim. A stainless steel or aluminum ring is welded into the production rim. It is then machined flat and concentric to provide the proper pilot diameter and bolt circle to match the transducer.

Power Cable



Power Supply cable. This cable is supplied from the factory with no connector on one end.

Signal Breakout Box



Analog Signal Breakout Box

Ethernet Cable



Ethernet Communications Cable (8 ft/2.4m length).

CAN Bus Cable



CAN Bus Signal output cable (8 ft/2.4m length). Each CAN cable is made per customer specifications. Data acquisition manufacturers use different connectors for CAN input, so Michigan Scientific makes the cable to work with a specific data acquisition.

Transducer ID Dongle



Transducer ID Dongle stores Transducer Calibration, Offset, Shunt Calibration, and RFID Information.

Telemetry Alignment Spacer



This spacer is used to properly align the Telemetry Stator to the Transducer.

WFT and Telemetry Stator Frequencies

The telemetry used in Michigan Scientific WFT-TELS broadcasts in the 2.407 to 2.487 GHz range. Each Transducer is set to a distinct frequency channel within that range so that each set of transducers do not interfere with each other. Each Telemetry Stator is programmed to a certain channel matching only one of the WFT-TELS in that set. Together they form a matched pair. If a Telemetry Stator gets damaged, a spare can be reprogrammed by the customer to the needed channel to replace the damaged Telemetry Stator. Information on reprogramming the Telemetry Stator can be found on page 53. Below is a list of the LW-MC-3.5K transducers supplied to Polaris in 2013 with their broadcast channels and the Telemetry Stator that they are mated with.

LW-MC-3.5K SN	Telemetry Channel	Mated Telemetry Stator SN
144	001	201
145	080	202
Spare	001	203

Assembly Instructions

This section of the manual describes the assembly of the transducer, wheel and hub adapters, and telemetry stator.

Before Assembly

- Be sure that all mating surfaces are free of dirt.
- Inspect mating surfaces for nicks and scratches.
- Place cardboard or wood down where the sensor is being assembled.
- Use care when assembling the sensor to avoid damage to any part of the system.

Assembly

- Use care when installing the tire to insure that the adapter mating surfaces and sensor do not get damaged.
- Pilot the transducer into the modified wheel and install and hand tighten sixteen M8 X 1.25 X 30 mm class 10.9 SHCS as shown in the picture below. Use temporary thread locker (e.g. blue Loctite®).



- Pilot the hub adapter into the transducer as shown in below and install and hand tighten eighteen M8 X 1.25 X 30mm class 10.9 SHCS. Temporary thread locker (e.g. blue Loctite®) is recommended on these bolts.



- Torque all of the M8 socket head cap screws to 15 lb-ft using a crisscross pattern. ***Do not over-torque the bolts. The transducer could be damaged.***
- Install the assembly and axle bearing alignment shims on the motorcycle per manufacturer's procedure.
- Install the assembly on the motorcycle. Tighten the lug nuts to the motorcycle manufacturer's specified torque.

Telemetry Stator Installation

The stator module is secured to the vehicle by the adjustable telemetry stator bracket. The stator bracket needs to be securely attached to a suspension component such that the position of the module with respect to the WFT remains unchanged.

Proper alignment of the stator module with respect to the WFT is critical. When properly installed there will be a ~ 2.5 mm air gap between the face-to-face surfaces of the stator module and transducer. Radial position and tilt orientations of the stator module with respect to the WFT are also critical. Use of a Telemetry Alignment Spacer is required to perform proper alignment. Pictures of the alignment Spacer are shown below. The Spacer is labeled for both the WFT & Stator side. Make sure it is in the proper orientation when aligning the Telemetry Stator.



This side should contact the WFT



This side should contact the
Telemetry Spacer

Place the spacer against the Telemetry Spacer as shown below.



Then press the Spacer and Telemetry Stator against the WFT as shown.



Next, while holding the Telemetry Stator in proper alignment, tighten down the bolts of the adjustable telemetry stator bracket. Once the bracket is secured to the Motorcycle and all the bolts are tightened, re-check the alignment by sliding the Telemetry Spacer between the WFT and Telemetry Stator. Re-adjust the alignment if needed. Then carefully remove the spacer and rotate the wheel. Observe it visually and make sure the Telemetry Stator does not contact the transducer as it rotates.

Final Transducer Installation

- If using multiple transducers, stack the CT2-TEL boxes together.
- Connect the loose end of the Telemetry Stator cables to the CT2-TEL boxes.
- Connect the power cable to the CT2-TEL box. Only one power cable is needed for two CT2-TEL boxes.
- Plug in the correct Transducer ID dongle. Make sure that the Transducer ID dongle has the same serial number as the transducer at the other end of the Telemetry Stator cable plugged into this CT2-TEL.
- Connect other end of the power cable to a DC voltage source in the range of 10 to 36 volts. The current draw from the motorcycle varies but should not exceed 2.5 amps at 13.8 volts and reduces proportionately at higher supply voltages.
- If using analog outputs, connect the Analog Signal Break-out Cable to the CT2 and then connect to the Somat cables data acquisition
- If using CAN Bus signal output, connect one end of the CAN Bus cable to the CT2 and the other end to the data acquisition.
- Turn the power switches on.
- At this time when in motorcycle coordinates, the force, moment, and position channels are held at zero until the CT2 receives an index pulse.

CT2-TEL



Introduction

One CT2-TEL box is used for each wheel force transducer. This box provides power to the primary induction coil, performs coordinate transformation, and serves as the user interface. The CT2-TEL also has an Auto tune button which finds the proper frequency for the induction to optimize power transfer of the induction system. A zero procedure automates the transducer-offset adjustment. Options allow the transducer to be used in both rotating or non-rotation modes and control bridge excitation. The user selects which side of the motorcycle the transducer is placed and corrections will be made to keep the output in SAE coordinates. Cross-axis sensitivity correction is performed. Error checking alerts the user if the system is out of tolerance. Finally, a shunt procedure calculates output sensitivities and allows the user to record shunt values.

Every time the CT2-TEL is first powered up the system will start a Shunt Calibration sequence. The Zero and Shunt button will be lit until this sequence is finished. Do not attempt to take data or perform a Shunt or Zero until this sequence is finished. It will take about 35 seconds.

Lights and Controls

All controls located on top of the enclosure are momentary contact switches. They correspond to the labels located on the front panel. Power, position, and Autotune controls are located on the front panel.

Power Switch

Note: It is good practice to first connect all cables to the CT2 electronics before powering it up. If this is not done, possible damage may occur. In addition, the CT2-TEL reads important transducer information, from the Transducer ID dongle, at startup. Incorrect offsets and gain settings will be used if this information is not read.

The power switch turns the power on and off. When the CT2-TEL is turned on, it defaults to Run Mode. This will be indicated by green lights on the front panel. Sensor offsets, sensitivities and other information is read from the smart sensor during power up.

Autotune Button

Whenever the transducer or Telemetry Stator has been moved to a different motorcycle the induction power needs to be retuned - this can be done with the Autotune feature. Before pressing the Autotune button, ensure that :

1. The proper Transducer and Telemetry Stator are a mated set from the list above.
2. The spacing between the two has been set with the Telemetry Alignment Spacer.

Press the button for 2-3 seconds and wait about one minute for the Autotune process to complete. The blue Induction Tuning LED should be on during this process.

Once the process has finished either the green Data Valid LED will come on or the red Induction Error light will come on.

If the green Data Valid LED comes on the transmitter is getting sufficient power and you should proceed.

If the red Induction Error LED comes on re-check that the two items listed above are correct. If you find one of these were not correct, fix them, and press the Autotune button again. If you think they are both correct, call Michigan Scientific for further help.

Zero

The Zero light indicates that the module is performing a zeroing sequence, invoked by the Zero button on top of the enclosure. This button is only active during the Setup Mode. The light is also used to indicate an error in the zeroing sequence when used in conjunction with the Fault light. The zeroing sequence records data and calculates an offset value. This offset is recorded into the memory chip located in the Transducer ID dongle therefore it is not lost when power is interrupted or a different CT2-TEL is used. The CT2-TEL uses 2 or 8 revolutions of the tire to calculate the offset. If the wheel is not turning when the Zero button is pressed, the calculation will be based on the next 2 revolutions. If the CT2-TEL senses that the wheel is turning, it uses 8 revolutions to get a better on-road-averaged value.

Shunt

The *Shunt* light is used to indicate shunt related features. The button located on top of the enclosure can be used to invoke a shunt sequence. The shunt calibration sequence lasts about 35 seconds.

Mode

The Mode lights indicate whether the module is in Setup or Run Mode. The Mode button on top of the enclosure toggles between these two modes. Run mode is used whenever data is being collected. Setup mode is only used when the transducer is being set up or when the operator is checking the transducer offsets. Zero, Shunt, and Position features cannot be accessed unless the CT2-TEL has been switched to Setup mode.

Zero Angle

The Zero Angle button is used to set the vertical position reference of the encoder. This is very important because this position reference is used to change wheel coordinates to vehicle coordinates.

- Raise the motorcycle on a hoist and make sure that it is level.
- Press the Zero Angle Button
- Rotate the Wheel until the LED under the Zero Angle Button begins to flash.

- The rotate the Transducer & Wheel so that the Z+ arrow on the Transducer points vertically down. Use an inclinometer or precise level to ensure that the Z+ arrow is exactly vertical.
- Press the Zero Angle Button again
- The reference angle for the encoder is now set

Coordinates

The wheel and vehicle lights indicate whether the output data is in wheel or vehicle (spindle) coordinates. The button on top of the enclosure toggles from one to the other. Wheel coordinates output the data directly from the wheel. This is used during laboratory testing when the transducer is not spinning. Vehicle coordinates transform the data from the wheel coordinates to vehicle coordinates. This is used for on-vehicle tests when the wheel is spinning.

Fault

The fault light indicates that there is a problem with the module. It can be lit in conjunction with other lights or by itself. More information is available in the trouble shooting section of this manual.

Position

The position button allows the user to indicate to the CT2-TEL what wheel position the transducer is mounted. Different coordinate transformation equations are used on the right vs. the left side of the vehicle. This information is also used by the CT2-TEL electronics to indicate in the CAN DBC file the identification of data being transmitted. In addition this allows the user to keep track of which electronics is attached to which wheel.

When stacked with one or more other CT2-TEL units, the position information is shared between the CT2-TEL electronics. If two or more CT2-TEL electronics are assigned to the same wheel location, the position lights on those electronics will blink slowly to alert the user.

Indicator Lights

WFT

Each WFT-TEL has an indicator green light behind the garolite telemetry ring. When the transmitter has power and is operating the green light will be lit.

Telemetry Stator

Each Telemetry Stator has two indicator lights. See the pictures below. A green indicator light means that the Telemetry Stator is operating and receiving signal from the Telemetry Transmitter of the WFT. It can be green in either operating mode or during a shunt calibration sequence. An red indicator light means that the Telemetry Stator is not receiving signal from the Telemetry Transmitter in the WFT.

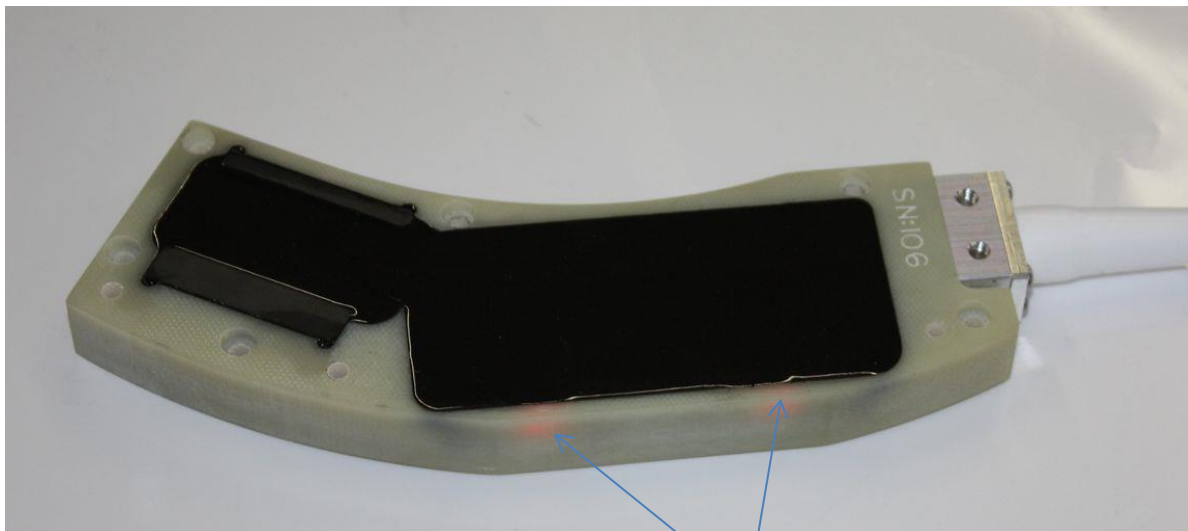

Telemetry Stator Indicator Light

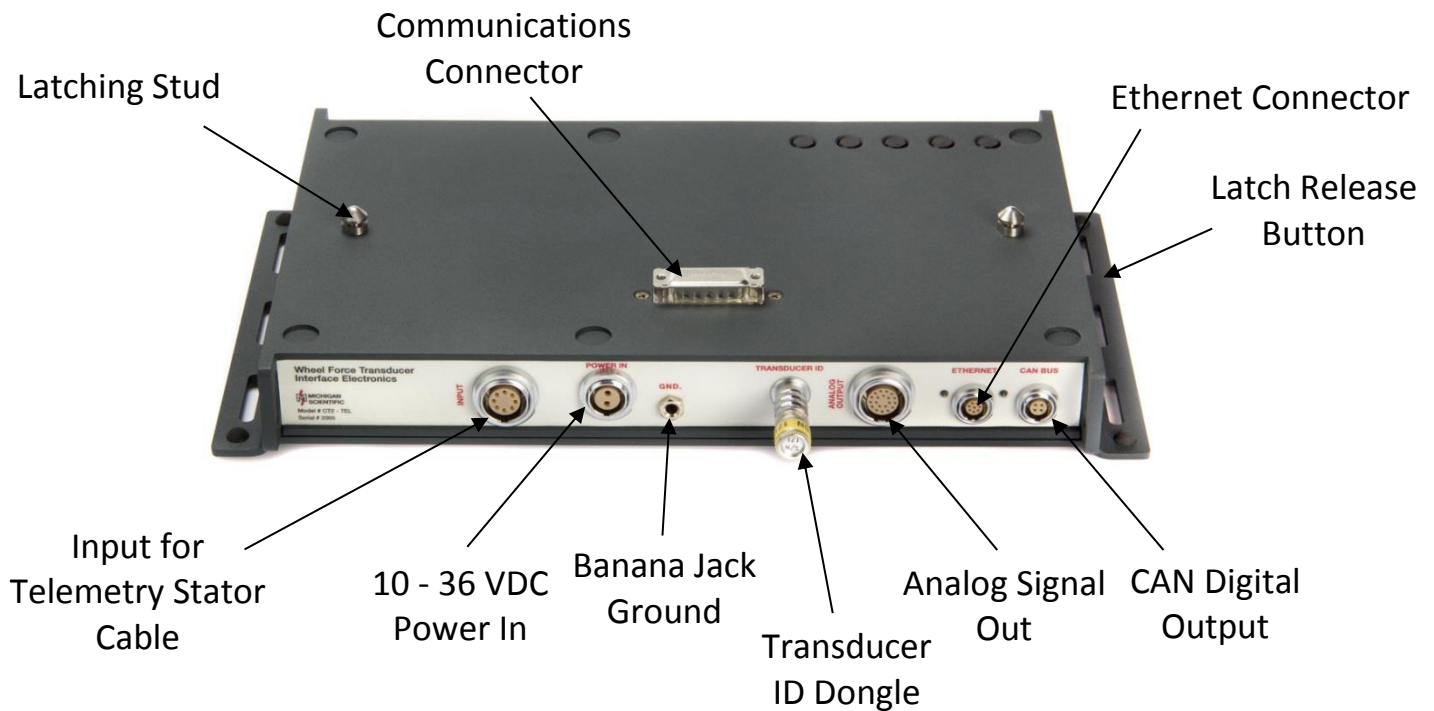

Connectors

Connectors located on the back panel of the CT2-TEL are for power, ground, Telemetry Stator Cable, analog output signal, Ethernet connection, CAN digital Signal output, and the Transducer ID dongle. The connectors located on top and bottom of the enclosure are used for communications between multiple CT2-TEL electronics.

Output Channels

Ten analog outputs are available at the Analog Signal Break-out Box shown in the photograph above. The channels are for force and moments about the x, y, and z axes, and also Wheel velocity, Wheel position, Sine, and Cosine. All of these channels are also available as digital signals using the CAN Bus signal output or Ethernet output.

Output Channel Sensitivities

The output channels for all systems are scaled as shown below. The CT2-TEL allows the user to choose analog output ranges of $\pm 10V$, $\pm 5V$, $\pm 2.5V$, and $0-5V$. The number shown is the full scale value for each channel. This number needs to be divided by the full scale voltage to calculate the sensitivity in units/volt. Example - If the full scale analog outputs are set to ± 10 Volt, the X Force sensitivity will be 400 lb/V ($4,000 \text{ lb} / 10 \text{ volts}$). If the

analog outputs are set to 0-5 Volt, X Force the sensitivity will be 1,600 lbs/Volt with a 2.5 volt offset.

NOTE: VERIFY OUTPUT CHANNEL SENSITIVITY BY MONITORING THE SHUNT CALIBRATION VOLTAGES AND COMPARING TO THE SHUNT CALIBRATION EQUIVALENT LOAD. THIS CAN BE FOUND ON THE CALIBRATION SHEET OF THE TRANSDUCER. CHANNEL SCALING MAY BE SET-UP DIFFERENTLY ON SOME TRANSDUCERS.

Output Channel Sensitivities		
X Force	1,779 N	400 lb
Y Force	712 N	160 lb
Z Force	1,779 N	400 lb
X Moment	217 N-m	160 lb-ft
Y Moment	407 N-m	300 lb-ft
Z Moment	217 N-m	160 lb-ft
Velocity	Default is 200 rpm/volt	
Position	0 - 360 deg	
SINE	± Full Scale	
COSINE	± Full Scale	

Zero and Shunt Control Function Table

Zero	Shunt	Mode	Bridge Power	Coordinates
N/A	N/A	Run	On	Wheel
N/A	N/A	Run	On	Vehicle
Stationary	Shunt	Setup	On	Wheel
Rolling	Shunt	Setup	On	Vehicle
N/A	N/A	N/A	Off	N/A

The above table shows all the different possible Mode and Coordinates settings that are possible.

Output Channel; Offset, Sensitivity and Transform Function Table

Control States			Outputs		
Mode	Coordinates	Bridge	Offset	Sensitivity	Coordinate
Run	Wheel	On	Yes	Yes	No
Run	Vehicle	On	Yes	Yes	Yes
Setup	Wheel	On	No	Yes	No
Setup	Vehicle	On	No	Yes	No
N/A	N/A	Off	No	Yes	No

Sensitivity adjustments are always performed to the data inside the CT2-TEL electronics. Offset adjustment and coordinate transformation are not always performed. The above table summarizes these states.

System Delay

Analog Signal Outputs

Due to filtering in the telemetry system there is a signal delay on the analog channels of the system. The delay is a fixed delay of 20.69 milliseconds and applies to all the channels. When using the wheel force transducers with other sensors the signal delay should be corrected. The correction can either be done in post-processing or by creating calculated channels in the data acquisition and performing a time based shift in real time.

CAN Bus Signal Outputs

If using the CAN Bus signal outputs there will be an additional 18 to 32 millisecond delay. This delay is in addition to the 20.69 millisecond analog delay. The total system delay will be between 38.7 and 52.7 milliseconds. The CAN Bus signal delay depends on the Output Rate selected. The filtering changes at different Output Rates and affects the signal delay.

Multiple CT2-TELS



Each CT2-TEL is used with one Wheel Force Transducer. When using multiple Wheel Load Measurement systems, the CT2-TEL is designed to be stacked. Latch studs are mounted on top of the enclosure and a latching mechanism is mounted on the bottom. When the boxes are set on top of each other, they latch together. A button on each side of enclosure releases the latches. Electrical connections are made via the D-sub connectors mounted on top and bottom of the enclosure. When not stacked it is recommended that the dust covers provided with the enclosure be used to cover the D-sub connectors. This will protect the connectors and reduce the chance of electrical damage to the electronics.

The CT2-TEL electronics communicate with each other using a digital bus interface. This allows the operator to control all of the CT2-TELS with one set of controls. Notice that the control buttons are located on top of the enclosure. When one CT2-TEL is stacked on top of another, the buttons on the lower one are covered. All functions are controlled by the top CT2-TEL at this time.

A base is available to provide better stability and tie down locations. This base also protects the D-sub connector on the bottom CT2-TEL.

The power supply cable can be connected to any one of the CT2-TEL electronics. That CT2-TEL will supply power to the rest in the stack.

Each CT2-TEL retains its own power switch and must be turned on individually. At power up, the CT2-TEL checks the state of the other boxes and then sets itself to match.

Up to four CT2-TEL electronics can be stacked together. If you want to stack more together, please contact Michigan Scientific to discuss your specific application.

Power Requirements

The CT2-TEL requires 10 to 36 VDC power. Power draw is less than 2.5 amps at 13.8 volts for each WFT system.

One power cable can power up to four stacked CT2-TELS. Michigan Scientific provides a power cable for every two CT2s purchased. If additional cables are required, contact Michigan Scientific.

Balancing – Zeroing

An electrical balance is critical to assure accuracy of wheel load measurements. Any electrical zero offset in the transducer or signal conditioning can introduce significant errors in the measurements. When measurements that are made on the rotating transducer are transformed to the stationary vehicle coordinate system, any zero offsets produce errors that are periodic at once-per-revolution. It is therefore important to reduce all zero offsets to a minimum.

The wheel load transducer is electrically balanced during fabrication. It is then temperature compensated to have minimum balance shift from -40 up to 200°F (-40 up to 93°C). The telemetry package and CT2-TEL are also designed to have minimal thermal offset over a wide temperature range.

The CT2-TEL has a Zero feature that automates the zeroing process. With any zeroing method used below, it is recommended that the sensors be exercised before any zeroing is done. To exercise the transducers, simply drive the vehicle around a few minutes.

There are three zeroing procedures.

1. Zeroing on the Hoist

This Zeroing method uses the weight of the wheel and tire to determine the zero offsets. This method is recommended for best accuracy.

Caution: It does not matter which direction you rotate the wheel during the zero sequence, however changing the direction of rotation during the zero procedure will cause errors. Remember when rotating one wheel on a drive axle, the one on the other side will turn the opposite direction. This is OK as long as the wheel does not change direction of rotation during the sequence.

- Turn on the CT2-TEL.
- While in *Run Mode* make sure the CT2-TEL is in *Vehicle Coordinates*
- Lift the tires clear of the ground.
- Press the *Setup Mode* button.
 - The blue Setup Mode light will illuminate.
- Press the *Zero* button. Note: The wheel must not be rotating when the *Zero* button is pressed.
 - The amber *Zero* light will illuminate.

Caution: While it is not important that the wheel be rotated at a steady rate, do not impart excessive acceleration or deceleration to the wheel while rotating it. This may cause calculation errors. To reduce errors, the CT2-TEL uses position-based sampling for this procedure.

- Rotate the transducer. When rotating the transducer, never apply force to the tire. This can cause an error in the zero calculations. Always apply force to the hub bolts if possible. Rotate in one direction until the amber *Zero* light goes out, this should take 2 revolutions.

Using more than one sensor with stacked CT2s

- You may rotate each transducer independently.
- To zero only one wheel, you will need to turn off the CT2-TEL electronics, on the wheels that you do not want to zero, or un-stack them.

- When the CT2-TEL completes the zero procedure, it will write the calculated offset value to the memory chip located in the Transducer ID dongle. This feature avoids the need to rezero the transducer when the power is interrupted or if a different CT2-TEL is used.

2. Rolling Zero on the Road

This Zero method uses the weight of the vehicle to determine the zero offsets. The Fy (Lateral) transducer channel may have real, non-zero values during this mode of operation due to toe-in and tire conicity. The My (Torque) may also have a real non-zero value due to drive line torque and brake or seal drag. Use rolling zero only when lower accuracy can be tolerated.

- While in *Vehicle Coordinates*, press the *Setup Mode* button.
- The blue *Setup Mode* light will illuminate.
- Coast the vehicle along a smooth and level section of road or parking lot above 15 rpm.
- Press the *Zero* button.
- The amber *Zero* light will illuminate.
- The CT2-TEL detects that the tires are turning and will use the average of the next 8 revolutions to compute the offset.
- Once the procedure is complete, the light will go out.
- When the CT2-TEL completes the zero procedure, it will write the calculated offset value to the memory chip located in the Transducer ID dongle. This feature avoids the need to rezero the transducer when the power is interrupted or if a different CT2-TEL is used.

3. Stationary Zero

This Zero method is only used in non-rotating applications, such as a simulator. It allows the user to null the output from the transducer.

- While in *Run Mode* make sure the CT2-TEL is in *Wheel Coordinates*

- The blue wheel light will illuminate.
- Press the *Setup Mode* button.
- The blue *Setup Mode* light will illuminate.
- Press the *Zero* button.
- The amber *Zero* light will illuminate.
- Once the procedure is complete, the light will go out.
- When the CT2-TEL completes the zero procedure, it will write the calculated offset value to the memory chip located in the Transducer ID dongle. This feature avoids the need to rezero the transducer when the power is interrupted or if a different CT2-TEL is used.

Once the initial setup is accomplished, data collection can continue for several days without readjustment. The vehicle should be lifted occasionally to verify the zero stability.

Verifying the Zero Procedure

To check the quality of the zero, set the CT2-TEL to *Run* mode and *Vehicle* coordinates. Observe the output from each channel with the wheel lifted off of the ground. The x and y-axes forces should have very little output. The z-axis force should read the negative weight of the wheel and tire. The y and z-axes moments should have little output. The x-axis moment should have some output proportional to the weight of the wheel and tire multiplied by the moment arm from the wheel centerline to the sensor centerline.

Spin the wheel and observe the x and z-axes force outputs. There should be very little ripple in the outputs. Offset errors will cause once-per-rev errors. Scaling errors will cause twice-per-rev variation errors. If excessive once-per-rev errors are seen, repeat the zero process. If excessive twice-per-rev errors are seen, perform a shunt sequence and then repeat the zero procedure.

For this transducer, the allowable output variations are plus and minus 0.25% of rated load or 30 lbs. for x and z-axes force channels.

Factory Calibration

Calibration values and cross-axis sensitivity coefficients are programmed into the Transducer ID dongle for each sensor. The wheel force transducer was statically calibrated in a load frame with a rigid outer ring in place of the modified rim.

An electrical shunt calibration was performed during physical calibration in the laboratory. During physical calibration, shunt resistor values are determined to establish equivalent physical load values. Shunt calibration resistor in the amplifiers were chosen to provide an electrical signal equal to approximately 25-60% of the rated capacity. Sensitivity calibration values in kilo-Newton/volt and pounds/volt are presented in the Appendix of this manual.

Radial forces were applied around the perimeter of the outer ring at 45° intervals. The forces were applied in each direction and data was recorded. The data were then fitted with least squares linear functions. Cross-axis sensitivity in each of the non-loaded axes were also recorded and fit with a linear approximation.

The calibration procedure was repeated with pure torque applied around each moment axis.

Shunt Calibration Sequence

After every Shunt Calibration Sequence (not including power-up) the CT2-TEL calculates an internal gain, used to make output sensitivities match what is programmed into the Transducer ID dongle

To invoke a shunt sequence.

- Press the *Mode* Button to enter *Setup Mode*
- Press and release the Shunt button.
- The Shunt light will illuminate to indicate a shunt sequence is in progress. Once the Shunt light goes out (about 35 seconds), the shunt sequence is complete.
- Press the *Mode* button to return to *Run Mode*.

If the Shunt light does not go out and the Fault light illuminates, the shunt sequence did not pass. Pressing the Shunt button will briefly cycle power to the telemetry transmitter, which invokes a shunt calibration resistor at each strain gage bridge in the transducer. The CT2-TEL reads the voltage change, caused by the shunt, and adjusts the gain of each

channel to match the sensitivity programmed into the Transducer ID Dongle. This calculated gain is recorded into the memory chip located in the amplifier package so this information is not lost when power is interrupted or a different CT2-TEL is used. If the calculated gain is more than 2.5% different than what is programmed into the memory chip, the shunt sequence does not pass.

Note: This sequence can be performed with the wheels on or off the ground with equal accuracy. However, if the wheels are on the ground, anything that causes force variations such as movement of the vehicle can cause errors in the shunt cal.

The calibration sheet lists system sensitivities in engineering units/volt and a shunt calibration equivalent values in engineering units.

These lb / volt sensitivities on the calibration sheet are only valid if the analog outputs are left as +/- 10 Volts Full Scale.

As good practice, the user should check the sensitivity by recording the outputs during a shunt sequence and calculating the delta (magnitude of change from positive shunt to negative shunt). The shunt value listed in the calibration sheet is defined as half of this delta.

In-field checkout can be done by parking the vehicle on a scale and comparing the transducer outputs with scale values. The scale values will differ from the output of the sensor by a little more than the weight of the tire and rim adapter.

Physical re-calibration services are available from Michigan Scientific.

Web Page Selectable Options

The CT2-TEL contains an embedded web page that can be used to change system settings or select features. This web page is available to any device with an Ethernet port and web browser.

To access the web page.

- Connect the Ethernet cable (provided with appropriate connectors) to one of the CT2-TELS and a computer. Note: To avoid network conflicts wireless networking should be turned off on the computer.
- Pull up a web browser

- Enter the IP address of the CT2-TEL into the browser bar (see below for more information on IP addresses)
- The web page, shown on the following page, will appear in the web browser

Note: To make system changes, all CT2-TELS must be connected to their respective wheel force transducer and powered up.

CT2 Serial Number:
2006

Wheel Force Transducer Information (from Dongle)
Model: LW-MC-3.5K
Dongle Serial Number: 144
Position: RF
Calibration Date: Fri Apr 5 2013

Default Coordinates on Power-Up (Updated in all active CT2 boxes):
 Wheel Vehicle

Full Scale Rotational Velocity:
 1000 RPM
 2000 RPM
 3000 RPM
 Replace CAN Position/Velocity Output with Sine/Cosine (Analog Full Scale Velocity Output Is Fixed to 3000 RPM)

Analog Output Range:
 +/- 10V +/- 5V
 +/- 2.5V 0 to 5V

Encoder Reference Angle:
110.21 Degrees Clockwise to Vertical

Measurement Origin
 Center of WFT
 User Defined with Respect to Center of WFT

Units of Entered Values:
 Inches
 Millimeters

Measurement Center Offset along Y-Axis (a):
0.00 (-730 to 730 mm)

Rolling Radius (RR):
0.00 (0 to 3660 mm)

For Simulator Use Only
 Check this Box if Transducer Z-Axis Is not Vertical (Affects Wheel Coordinates Output Only):
0.00 Angle In Degrees Clockwise from Vertical

Update All Active CT2 Boxes with these Settings
[Update](#)

CT2-TEL Serial Number

Near the top of the page is a drop down box allowing the user to select CT2-TEL serial numbers, shown below.

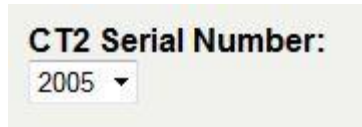

The CT2-TEL that the Ethernet cable is connected to will check for the presence other CT2-TEL electronics. These other units need to be stacked together and all units need to be turned on. If other units are present, and turned on, the serial numbers of these units will appear in the pull down menu. Selecting a different serial number allows the user to set up each CT2-TEL separately.

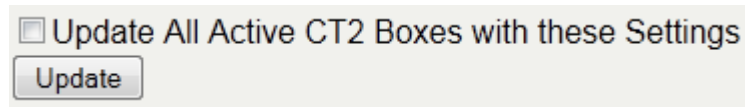

If settings for all the CT2-TEL units are to be the same, the "Update All Active CT2-TEL Boxes with these Settings" button can to be pressed before the "Update" button is pressed. Updating all units at once avoids the need for the user to go through the settings for each serial number individually if settings for all units are to be the same.

The Wheel Force Transducer Information shown below serial number is information for the WFT that is connected to the selected serial number.

Default Coordinates on Power-Up

The CT2-TEL defaults to Vehicle coordinates at start up, which for most on-the-road testing, is desired. However, when used on a simulator, the CT2-TEL should be in wheel coordinates. If the CT2-TEL powers up in Vehicle coordinates when used on a simulator, the operator must remember to change the coordinates setting to Wheel coordinates each time power is cycled. This option allows the user to change the default to Wheel coordinates at startup so that it is not necessary to make this change each time the CT2-TEL is powered up.

Default Coordinates on Power-Up (Updated in all active CT2 boxes):

Wheel Vehicle

Note: All CT2 electronics, shown in the serial number drop down menu when this setting is changed, will take the new setting even if the "Update All Active CT2 Boxes with these Settings" button is not checked.

Full Scale Velocity

This setting is used to set the full scale velocity of the wheel speed signal derived from the encoder. There are three full scale velocities. The full scale velocities are 1,000, 2,000, and 3,000 rpm full scale. The default setting is 2,000 rpm full scale. The user may also select to replace the position and velocity signals (on the CAN outputs only) with Sine and Cosine signals. If this option is checked, the full scale velocity on the analog channels will be 3,000 rpm.

Full Scale Rotational Velocity:

- 1000 RPM
 2000 RPM
 3000 RPM
 Replace CAN Position/Velocity Output with Sine/Cosine
(Analog Full Scale Velocity Output is Fixed to 3000 RPM)

Analog Output Ranges

For the Analog outputs, the full scale output voltage can be set as shown below to accommodate data acquisitions systems that cannot accept ± 10 volt signals. The CT2-TEL changes the output sensitivity to use the full scale range.

Analog Output Range:

- +/- 10V +/- 5V
 +/- 2.5V 0 to 5V

Note: The Analog outputs use a 16 bit DAC. When a different voltage range is selected, the resolution of the data is no longer 16 bits because the CT2-TEL does not utilize the full

16 bit range of the DAC. When using +-5 volt range the resolution is reduced to 15 bits. When using +-2.5 or 0-5 volts the resolution is 14 bits.

Measurement Origin

The default measurement origin of the LW-MC-3.5K is the center of rotation and a plane that runs through the center of the transducer beam elements. The distance to the measurement origin plane from the front face is 0.763" (19.4 mm) and the distance to the measurement origin plane from the back face of the transducer is 0.500" (12.7 mm).

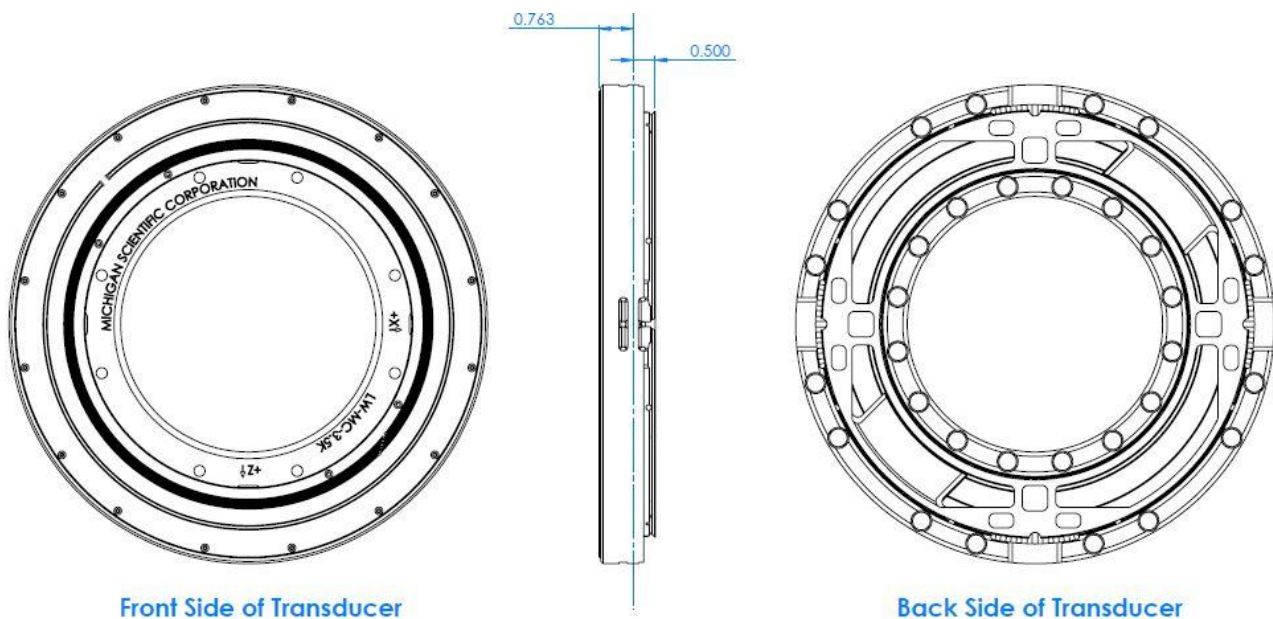

In some situations, the user may wish to change the location of the Measurement Origin (i.e.; resolve forces and moments to the vehicle hub). This option allows the user to input "a" (The length of the lever arm along the Y-axis from the transducer mid-plane to the desired location) and "RR" (The rolling radius or the length of lever arm along the Z-axis). Positive "a" is defined as the distance the measurement origin is to be moved towards the vehicle centerline. Positive "RR" is defined as the distance the measurement origin is to be moved down towards the ground, along the positive Z-axis in Vehicle Coordinates.

“RR” can only be entered as a positive value. The default setting for the measurement origin is the WFT center.

Measurement Origin

Center of WFT
 User Defined with Respect to Center of WFT

Units of Entered Values:
 Inches
 Millimeters

Measurement Center Offset along Y-Axis (a):
20.02 (-7999 to 7999 mm)

Rolling Radius (RR):
29.79 (0 to 15999 mm)

To use this option:

- Check the button labeled “User Defined with Respect to Center of WFT”
- Select “Inches” or “Millimeters” to indicate which units will be used.
- Enter an “a” value if moving the origin along the y-axis.
- Enter an “RR” value if moving the origin along the Z-axis.

The image below indicates “a” and “RR” values.

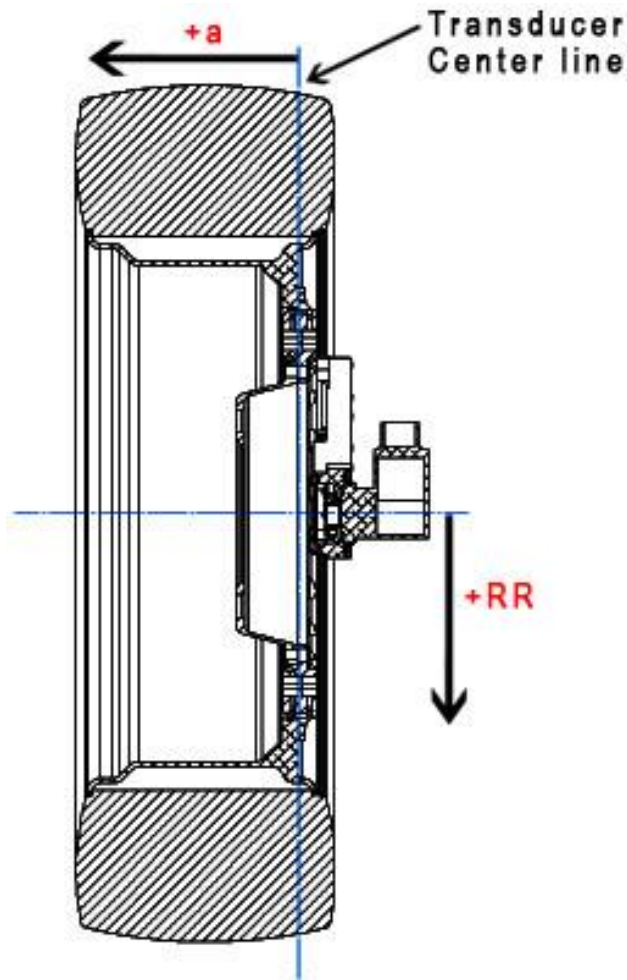

Note: Only the M_x and M_z channels are affected by these calculations. Ignoring force due to acceleration and mass of the WFT system, the forces do not change when the measurement origin is moved. M_y is not changed because the location of the tire patch can vary enough to introduce large errors into the calculation.

Transducer Orientation in Simulator Use

The WFT cannot always be mounted with the transducer Z-axis in line with the vehicle Z-axis.

In this situation:

- Check the box labeled “Check this Box if Transducer Z-Axis is not Vertical”

- Enter the angle that the transducer is from vertical with positive defined as how far the transducer is rotated from vertical in the Clockwise direction.

For Simulator Use Only	
<input type="checkbox"/> Check this Box if Transducer Z-Axis is not Vertical (Affects Wheel Coordinates Output Only):	
0.00	Angle in Degrees Clockwise from Vertical

Changing WFT Coordinate System

The default WFT coordinate system is the Left Hand Coordinate System shown below. In the Coordinate System tab on the CT2 webpage the WFT coordinate system can be switched to a Right Hand Coordinate System by checking the button labeled “Right Hand” then clicking update at the bottom of the page. This will update all CT2 boxes stacked and powered up. The WFT Coordinate System is explained further on page 50.

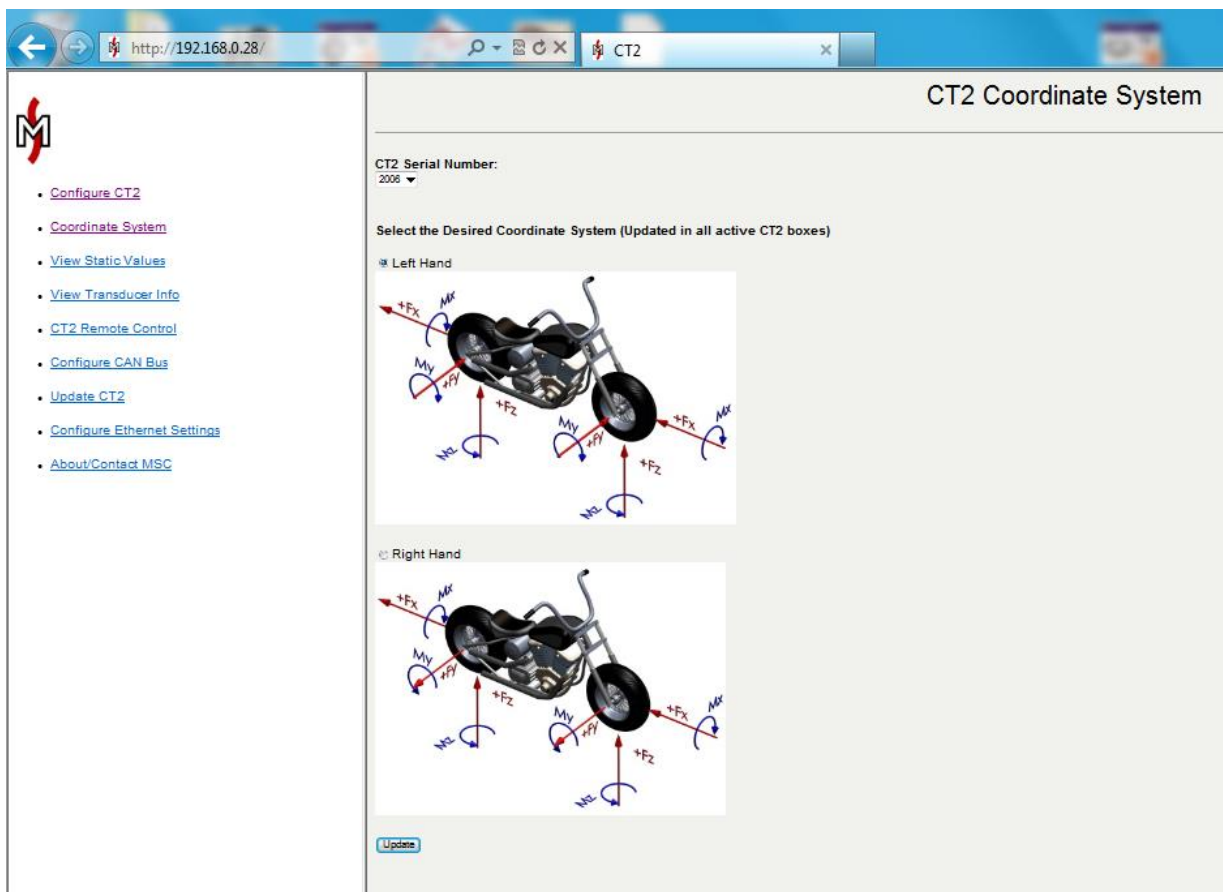

CT2-TEL Ethernet Configuration

Default IP addresses are set at 192.168.0.28 at the factory for all CT2s. A new IP address can be set by going to the "Configure Ethernet Setting" tab located on the left side of the web page. The IP address, Network Mask, and Network Gateway can be changed by entering a new number and pressing the Update button as shown below.

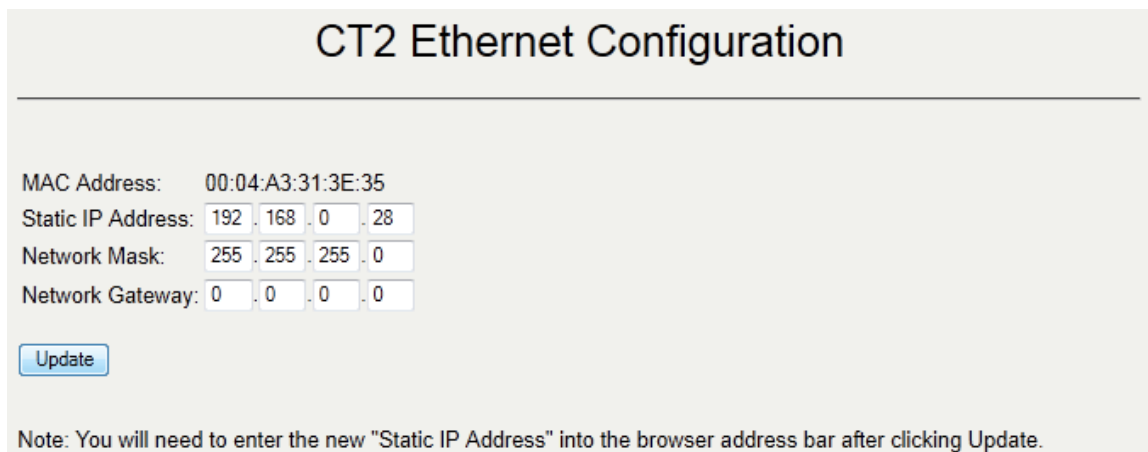

CT2 Ethernet Configuration

MAC Address: 00:04:A3:31:3E:35
Static IP Address: 192 . 168 . 0 . 28
Network Mask: 255 . 255 . 255 . 0
Network Gateway: 0 . 0 . 0 . 0

Note: You will need to enter the new "Static IP Address" into the browser address bar after clicking Update.

In the event that the Ethernet Configuration was changed away from the default setting and not recorded, it can be reset to the defaults shown above.

To reset the Ethernet Configuration Settings to the values shown above,

- Shut off the power switch on the CT2-TEL
- Press the position button
- Turn on the power switch while continuing to hold the position switch for a minimum of 1 second after the CT2-TEL powers up.
- The Ethernet Configuration Settings will reset to the values shown above.

Static Values

The Web page can be used to view static transducer output values during setup. Select "Static Values" on the upper left side of the web page. The web page displays the static values for all active WFT systems, shown below.

Static Values

Forces: N, Moments: Nm

CT2 SN	WFT Pos	X Force	Y Force	Z Force	MX Moment	MY Moment	MZ Moment	Position(Deg.)
2005	LF	0.00	0.00	0.00	0.00	0.00	0.00	356.84
NA	RF	NA	NA	NA	NA	NA	NA	NA
NA	LM	NA	NA	NA	NA	NA	NA	NA
NA	RM	NA	NA	NA	NA	NA	NA	NA
NA	LR	NA	NA	NA	NA	NA	NA	NA
NA	RR	NA	NA	NA	NA	NA	NA	NA

Note: When in "Vehicle" Mode zero values will be shown until an index pulse is received from the encoder. Please rotate the wheel until actual static force/moment values are displayed.

Page Refresh Rate:

- None
- 1 Second
- 3 Seconds
- 5 Seconds

Refresh rates can be changed by selecting from the options at the bottom of the page.

Transducer Information

Information for each WFT system can be viewed by clicking on “Transducer Info”. The CT2 Serial number drop down menu allows the user to select which system the information is for.

The screenshot shows a web browser window with the address bar displaying 'http://192.168...' and a tab titled 'CT2'. The main content area is titled 'Transducer Info (from Dongle)'. On the left side, there is a navigation menu with several links: 'Configure CT2', 'Coordinate System', 'View Static Values', 'View Transducer Info', 'CT2 Remote Control', 'Configure CAN Bus', 'Update CT2', 'Configure Ethernet Settings', and 'About/Contact MSC'. The main content area displays the following information:

CT2 Serial Number: 2006

Report Date: Thu May 9 2013
Report Time: 2:30:47 PM

Wheel Force Transducer Information (from Dongle):

Model: LW-MC-3.5K
Dongle Serial Number: 144
Position: RF
Calibration Date: Fri Apr 5 2013

	X Force	Y Force	Z Force
Shunt Cal Value (N)	6881	4553	6540
Factory Scale Factor	1.128	1.857	1.123
Field Scale Factor	1.127	1.859	1.124
Scale Factor % Difference	0.043	-0.108	-0.098
Analog Full Scale Output (+/- N)	17790	7120	17790
Transducer Offset (Volts)	0.012	-1.172	-0.005
Transducer Offset (N)	21.7	-834.2	-8.1

	X Moment	Y Moment	Z Moment
Shunt Cal Value (Nm)	1434	1498	1415
Factory Scale Factor	1.945	1.086	1.912
Field Scale Factor	1.945	1.087	1.918
Scale Factor % Difference	-0.016	-0.051	-0.166
Analog Full Scale Output (+/- Nm)	2170	4070	2170
Transducer Offset (Volts)	-0.017	0.002	-0.026
Transducer Offset (Nm)	-3.6	0.7	-5.7

Configuration Settings:

Full Scale Rotational Velocity: 2000 RPM

Encoder Reference Angle: 110.21 Degrees Clockwise to Vertical

CT2-TEL CAN Bus Configuration

CAN bus data output settings are configured using the “CT2 CAN Bus Configuration” option located on the left side of the web page. The CT2-TEL CAN bus interface bit rate must be set to match the CAN bus interface bit rate of your data acquisition system. If they do not match then CT2-TEL data will not be recognized by the data acquisition system. The CAN bus bit rate directly affects the number of samples per second that the

CT2-TEL can place on the CAN bus as well as the number of possible error retransmissions if an error occurs with a CAN message. Clicking update will update this setting for all active CT2-TEL boxes that are stacked together.

CT2 CAN Bus Bit Rate (Must Match Data Acquisition CAN Bus Interface Bit Rate):
 1 mbps ▼

Note: It is necessary that the CT2-TEL box receive a CAN acknowledge bit from the connected data acquisition system. Do not use passive (listen-only) mode on your data acquisition.

Another factor that affects the number of samples per second that can be output on the CAN bus is the number of CT2-TEL boxes per CAN bus interface on your data acquisition system. The chart below gives some recommended guidelines as to the maximum CT2 CAN output rates that you should use based on how many CT2 boxes are connected to each CAN bus interface on your data acquisition. The chart assumes a CAN bit rate of 1 Mbps and that no other devices are on the CAN bus.

	Recommended Maximum CT2 CAN Output Rates	
# of CT2 Boxes per CAN Bus @ 1 Mbps	Sample Output Rate (Samples/Sec)	# of Possible Error Retrans.
1	2,048	1
2	1,250	1
4	650	2

The CAN Bus data output rate can be adjusted between 250 to 2500 samples per second. A decimal place is allowed (e.g. 409.6 samples/second). Note: You should verify that your data acquisition is capable of sampling CAN data at your desired CT2 digital data output rate. Clicking update will update this setting for all active CT2 boxes that are stacked together. The approximate through delay from the analog input to the start of frame bit of the 1st message on the CAN bus is displayed in milliseconds for the entered data output rate.

Digital Data Output Rate (250 to 2,500 Samples/Sec):
500.0 Samples/Second

A CAN database (.dbc) file that can be imported by many data acquisition systems is dynamically created for all active CT2-TEL boxes that are stacked together. This file describes which CAN message id and corresponding data bytes go with each data channel/wheel position. It also describes each channel's name, units and scale factors. The engineering units and scale factors used in the .dbc file can be selected as Newtons, Newton-Meters (N,Nm) or Pounds, Pound-Feet (lbs, lb-ft).

Force/Moment Units and Scale Factors Used in CAN Database File:
 lbs, lb-ft
 N, Nm

Note: If alternate unit text is desired it can easily be edited by changing the unit text between quotes in the .dbc file.

There are two CAN messages output per sample for each CT2-TEL box. These messages must have a unique 11-bit message id to be recognized by the data acquisition system. Here you can change these CAN message ids for each active CT2 box that are stacked together. In the table you will find the CT2 box sn, pos and data channels that correspond with each CAN message id.

CAN Bus Termination

Also in the table, you can set whether 120 ohm CAN bus termination is supplied per each active CT2 box by checking the CAN Bus Termination Box. Every CAN bus must have 120 ohm end-to-end termination. For 1 CT2 box connected to 1 data acquisition CAN interface, both the CT2 box and the data acquisition should have 120-ohm terminators. Additional CT2 boxes (nodes) connected between the end-to-end points must not have 120-ohm CAN termination. For example, for a 2 to 1 CAN cable, one CAN BUS

Termination Box must be checked and the other one must be unchecked. For a 4 to 1 CAN cable, one CAN BUS Termination Box must be checked and the other three must be unchecked. When using two 2 to 1 CAN cables, the user must identify which SN CT2s are connected to each CAN cable. Then the user must uncheck the CAN Bus Termination Box for one of the two CT2s connected to each cable.

Set 11-bit Message Ids: 0x001 to 0x7FF and CAN Bus Termination:

Msg ID(Hex)	Box SN	Box Pos	Msg Channels	CAN Bus Termination
0xNA	NA	LF	FX, FY, FZ, MX	NA
0xNA	NA	LF	MY, MZ, Velocity, Position	
0x 30	2	RF	FX, FY, FZ, MX	<input checked="" type="checkbox"/>
0x 40	2	RF	MY, MZ, Velocity, Position	
0xNA	NA	LM	FX, FY, FZ, MX	NA
0xNA	NA	LM	MY, MZ, Velocity, Position	
0xNA	NA	RM	FX, FY, FZ, MX	NA
0xNA	NA	RM	MY, MZ, Velocity, Position	
0xNA	NA	LR	FX, FY, FZ, MX	NA
0xNA	NA	LR	MY, MZ, Velocity, Position	
0xNA	NA	RR	FX, FY, FZ, MX	NA
0xNA	NA	RR	MY, MZ, Velocity, Position	

Note: Velocity & Position will be replaced by Sine and Cosine if they are selected.

The .dbc file is located in the text box at the bottom of the “CT2 CAN Bus Configuration” page. To use the file click the SAVE TO DISK icon, then select the desired file location and file name. Make sure that the file extension is .dbc before you save.

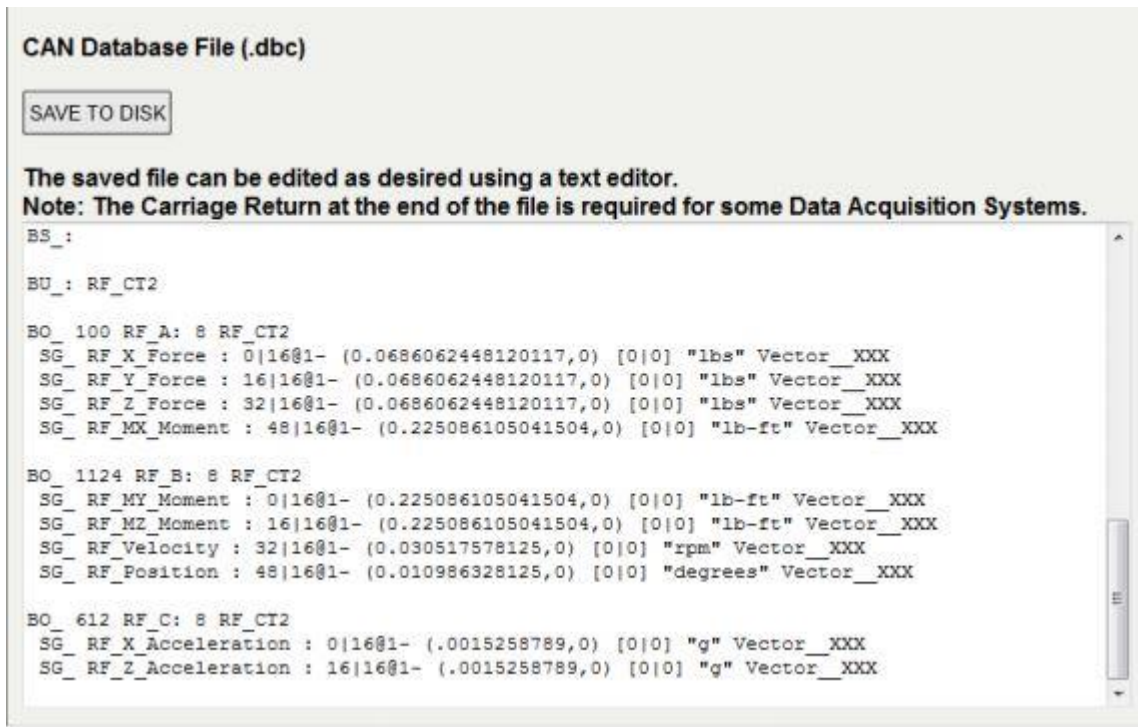

CT2-TEL Remote Control

The CT2-TEL stack can be controlled via the web page by selecting “CT2 Remote Control” at the upper left side of the web page. This allows the buttons on the CT2 to be controlled remotely via the Ethernet connection. This is especially useful when used in the lab because it allows the user to control the CT2-TEL from the control room.

CT2 Remote

Remote Control the CT2(s) Here:

Zero	Shunt	Run/Setup Mode	Bridge Power	Wheel/Vehicle Coordinates	Fault
Off	Off	Run	On	Vehicle	Off
zero	shunt <input type="checkbox"/> Hold Positive Shunt	mode	bridge	coords	

Updating Firmware in CT2-TEL

The embedded web page allows the user to easily update firmware without having to send the CT2-TEL back to the factory. This allows updates or repairs to be done in the field.

Update CT2

CT2 Firmware Information & Last 10 History Codes:

CT2 SN	WFT Pos	Loaded Firmware Version	Smart Sensor Version	HC1	HC2	HC3	HC4	HC5	HC6	HC7	HC8	HC9	HC10
2005	LF	T004_T008_A112	10	43	43	21	21	90	21	21	21	21	21
NA	RF	NA	NA	NA	NA	NA	NA	NA	NA	NA	NA	NA	NA
NA	LM	NA	NA	NA	NA	NA	NA	NA	NA	NA	NA	NA	NA
NA	RM	NA	NA	NA	NA	NA	NA	NA	NA	NA	NA	NA	NA
NA	LR	NA	NA	NA	NA	NA	NA	NA	NA	NA	NA	NA	NA
NA	RR	NA	NA	NA	NA	NA	NA	NA	NA	NA	NA	NA	NA

Note: Each CT2 must be updated individually using its own Ethernet port.

Upload a New Firmware File to the Highlighted CT2 Above:

Upload Progress:

Writing Progress:

If an update is available, Michigan Scientific will provide an installation file. Save this file in a convenient location.

To update the CT2:

- Connect the Ethernet cable to the electronics to be updated.
- Press the Browse button and select the installation file.
- Press the Upload button

- The file will be uploaded. Follow the prompts on the web page.
- Once complete you will be prompted to cycle power on the CT2.
- Once power has been cycled, the new firmware is ready to be used.

Caution: Do not disconnect the CT2 or power down the computer or CT2 during the update. Possible damage may occur which will require the electronics to be sent back to Michigan Scientific for repair.

Note: Only the CT2 connected to the Ethernet Cable will be updated. Each CT2 electronics must be updated separately.

Note: Update all CT2 electronics with the same version of firmware before using them in a stacked configuration.

Transducer Offset Check

It is recommended that the customer keep track of the transducer offset over time. If the offsets for each channel remain consistent with the factory offset listed on the calibration sheet, re-calibration is not necessary.

- Remove hub and wheel adapters. Hub and Wheel adapters can cause a small shift in transducer offset when they are bolted up. This is normal and the sensor will return to its original offset once they are removed.
- Set the sensor flat on the bench.
- Connect the amplifier to the sensor.
- Connect the cable to the slip ring and CT2.
- Power up the CT2.
- Press the *Mode* button to put the CT2 into *Setup* mode.
- Record the output for each channel.

Cross-Axis Sensitivity

The cross-axis sensitivity for each wheel force transducer was measured in a rigid laboratory test fixture. These numbers are recorded in the smart sensor where the CT2 uses them to correct any errors due to linear cross-axis sensitivity.

Weatherproofing

All connectors should be covered with fusion tape to keep water and dust out of the connectors. The connectors are designed to be weatherproof but the tape provides some extra protection.

Wheel Offset Considerations

Wheel offset from the centerline of the tire to the centerline of the transducer produces a moment about the vehicle X-axis due to the vertical load. When considering the load rating of the transducer, this moment is added to the moment produced by side loading at the tire patch.

Sampling Frequency

Much of the work done with WFTs is for wheel or chassis load measurement with a frequency of interest below 100 Hz. A sampling rate of 1,000 samples/second and pre-sample filter of 400 Hz. are usually adequate. This gives a sample approximately every 6 inches (15 centimeters) of a wheel traveling at 150 mi/hr (240 km/hr). For impulsive loads such as that encountered when striking a pothole, a sampling rate of up to 4000 samples/second may be necessary to define the peak loads to within a few percent.

Understanding SAE Coordinates

SAE Coordinates define positive X-axis as directed towards the front of the vehicle, positive Y-axis to the driver's right and positive Z-axis into the ground. Associated moments are per *the right hand rule*. See figure below.

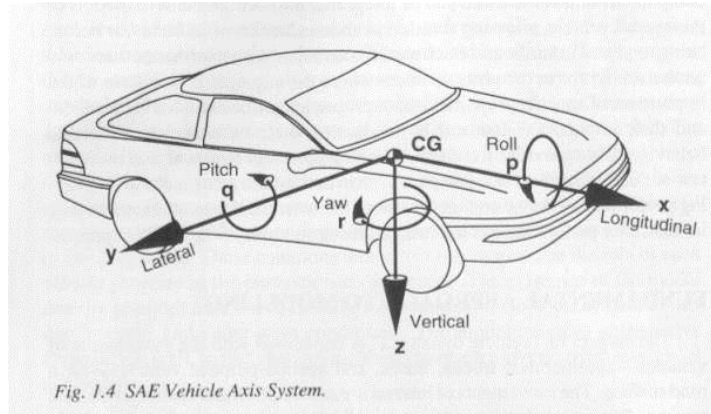

Positive transducer output is defined as a force or moment applied by the spindle to the tire per positive SAE coordinate directions e.g. +Fz WFT data is the spindle forcing the tire down (i.e. tire forcing spindle up). It is good measurement engineering practice to perform a system polarity check on each channel by physically loading the transducer. The following figure shows the positive direction for force and moment application (i.e. forces applied to the tire in the direction indicated by the arrows will result in a positive output).

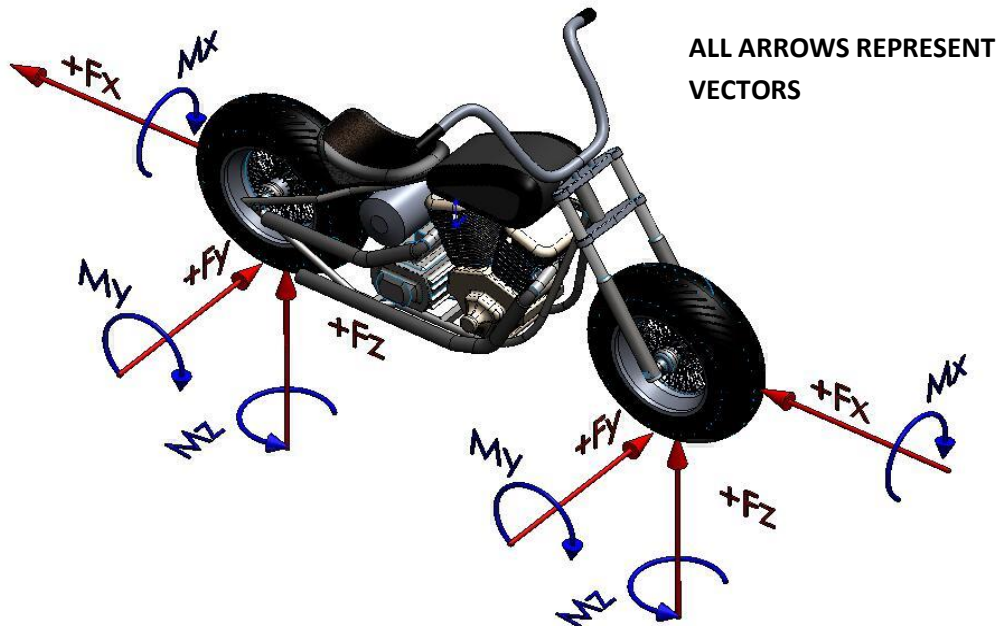

With regards to the WFT measurement system, the origin of the SAE coordinate system is placed at the perpendicular intersection of the axis of wheel rotation and an imaginary plane that passes through the centerline of the transducer's spokes.

The WFT channels are defined as:

F_x = Longitudinal Force

F_y = Lateral Force

F_z = Vertical Force

M_x = Roll Moment (Wheel Camber)

M_y = Pitch Moment (Wheel Torque)

M_z = Yaw Moment (Wheel Steer)

Right Hand Rule Coordinate System (Optional)

An option is provided to change the WFT coordinate system to one that follows the right hand rule. Changing the system to this coordinate system can be done in the CT2 embedded webpage. This optional coordinate system will switch the polarity of the F_y and M_y outputs. The following figure shows the positive direction for force and moment application (i.e. forces applied to the tire in the direction indicated by the arrows will result in a positive output).

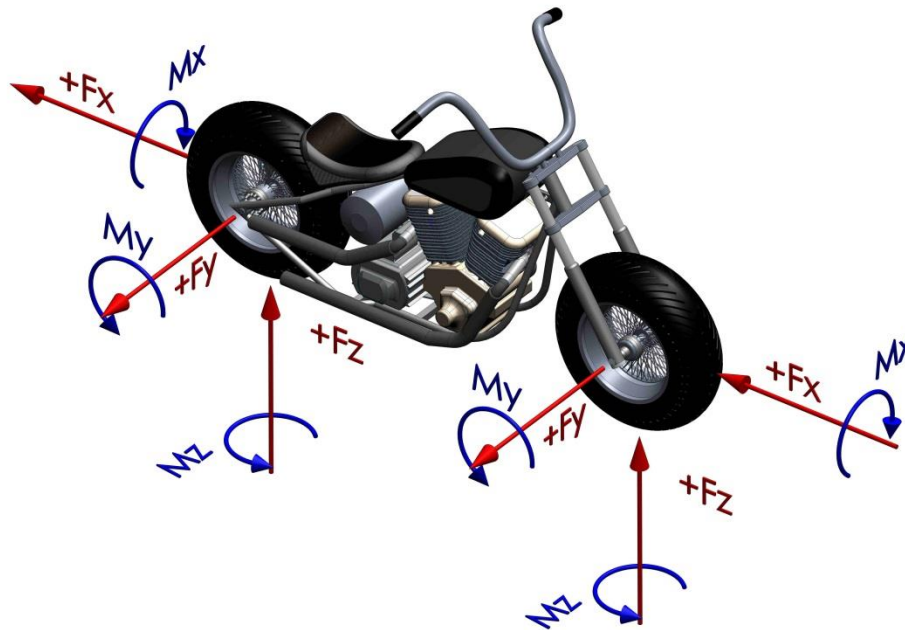

WFT Channel Recovery

Background

WFT Channel Recovery is only needed if a spare Telemetry Stator needs to be swapped for an originally mated Telemetry Stator.

Procedure

Find out the serial number of the transducer that you want to use this Telemetry Stator with. Find the dongle with the matching serial number and plug it into the CT2-TEL.

Power up the CT2-TEL and connect to the webpage. Add the extension “/telem.ssi” to the web address.

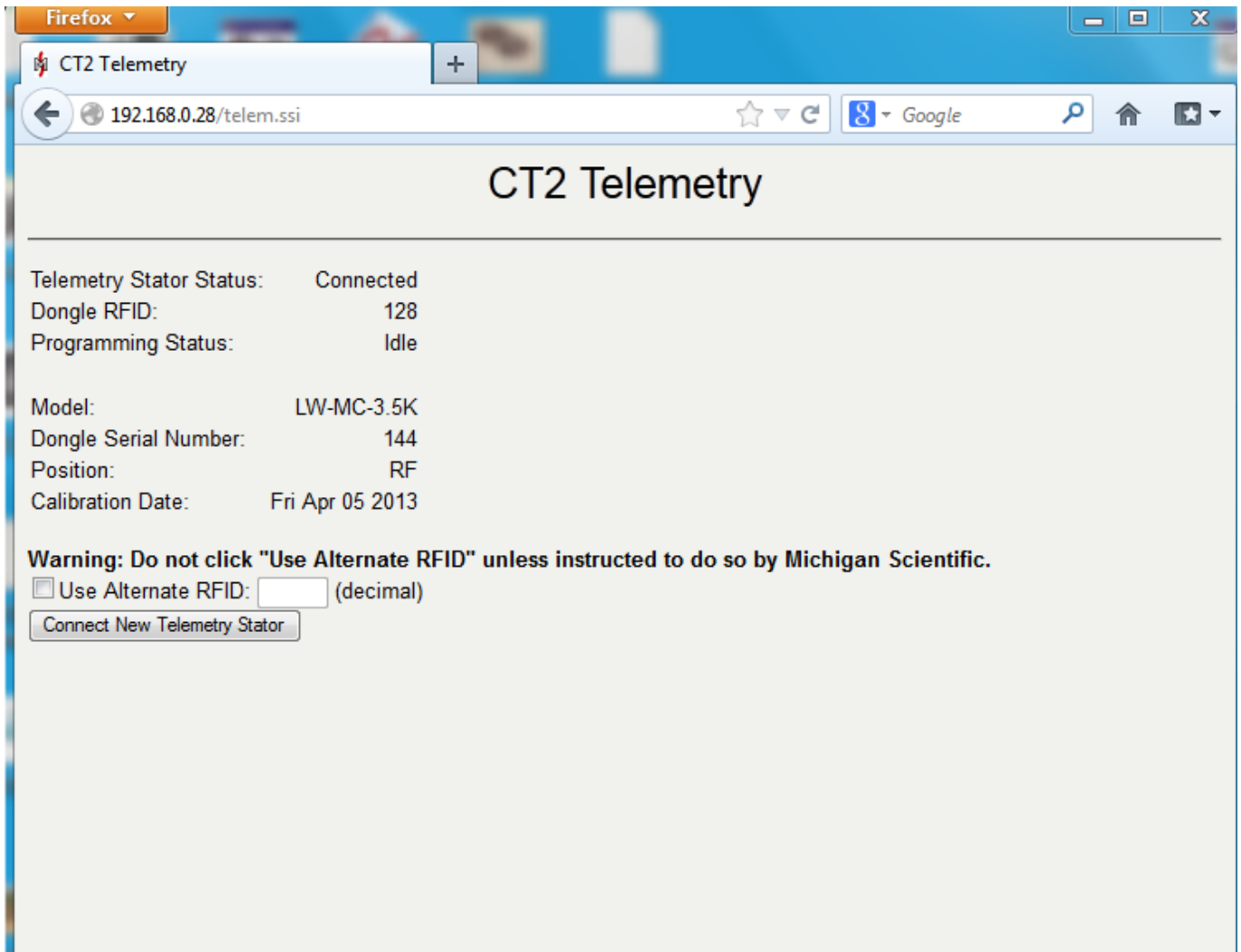

The webpage below should appear and list a Dongle RFID . Type that RFID into the box on the page and click on the “Connect New Telemetry Stator” button. Once the Telemetry Stator has been reprogrammed the Telemetry Stator Status will be “Connected”. Once this is complete install the Telemetry Stator as normal as proceed with installation. Record which Telemetry Stator is programmed at which frequency if you make a change.

Troubleshooting

Symptom	Possible Causes	Solution
CT2 Does not power up when the power switch is turned on.	Power cord not connected to power. Power supply polarity is incorrect.	Check that power cord has power supplied to it and try to power up the CT2 again. Check polarity, if incorrect, reverse power supply leads and try to power up the CT2 again.
Fault light illuminates at startup	Transducer ID Dongle not plugged in.	Plug in Transducer ID dongle corresponding to transducer being used with CT2
Fault light illuminates immediately after a button is pressed.	Internal communication error	Cycle power, leave box off for 5 seconds before turning power back on, Resume operation
Induction Error LED is lit ON Power Up	Telemetry Stator not plugged in or spaced properly to Transducer. Autotune has not been run	Check that Telemetry Stator cable is plugged in and that the spacing between the Telemetry Stator and the Transducer has been properly set. After above has been verified, Press Autotune Button
Induction Error LED is lit AFTER AUTOTUNE SEQUENCE IS FINISHED	Telemetry Stator not receiving signal from WFT-TEL Transmitter Insufficient Power being supplied to Transmitter	WFT-TEL and Telemetry Stator are not on same Telemetry Channel Alignment between Telemetry Stator and Transducer not set properly
After zero sequence, Zero light goes out but Fault light illuminates.	Sensor offset greater than 4 volts. The electronics will still zero the channel that has greater than 4 V offset but it alerts the user. This condition can cause the system output to saturate before it reaches full scale. The Fault light will go out next time the power is cycled.	With wheel off of the ground, change CT2 to Setup mode and check output voltages. Confirm which channel has an offset greater than 4 V. Unbolt the wheel adapter. If offset goes away, check adapter to see that it is not damages. If offset does not go away, unbolt the hub adapter. If offset goes away, check adapter to see that it is not damaged. If offset does not go away, send sensor in to Michigan Scientific for Checkout and repair.

Symptom	Possible Causes	Solution
Shunt light does not go out and fault light illuminates after a shunt sequence.	Force input to the sensor during shunt sequence causes out of tolerance shunt. CT2 failed to record data in memory chip. Sensor is out of tolerance. Insufficient power provided by Induction	Jack up vehicle, cycle power, and repeat the shunt sequence. Check the cable connections, cycle power, and repeat the shunt sequence. Send the sensor in for checkout and calibration. See Induction Error LED is lit ON Power Up or Induction Error LED is lit AFTER AUTOTUNE SEQUENCE IS FINISHED
Data has once-per-revolution wave form.	The zero is not correct. The tire can have stiffness variations, which will appear as once-per-revolution variations. This is a real force. Wheel adapter can be bent or out of tolerance. The force is real.	Perform zero procedure. If force variation is not acceptable, replace the tire. If force variations are not acceptable, replace the wheel adapter.
Data has twice-per-revolution waveform.	The sensitivities are out of tolerance due to incorrect or corrupted sensitivity values. One of the strain gage bridges has failed.	Perform the shunt sequence. It is important that no dynamic forces are imposed on the sensor at this time. These forces can come from movement in the vehicle. For best accuracy, lift the wheel off the ground. Check the outputs during the shunt sequence and check the zero data when the CT2 is in setup mode. If the shunt value is not correct or the zero has shifted, send sensor in for checkout and repair.
Fx, Fz, Mx, and Mz channels look like Sine waves when wheel is turning	CT2 is set to wheel coordinates. CT2 is in setup mode.	Check status of lights on front panel. If the Wheel Coordinates light is illuminated, press the Coordinates button on top to change back to vehicle coordinates. Check outputs. If the Setup Mode Light is illuminated, press the Mode button on top to change back to run mode.

Symptom	Possible Causes	Solution
Channels, which should have no load, have an offset even after the zero procedure is performed.	Data channels have error due to rolling zero procedure	If the rolling zero procedure was performed on the road, there will be real forces that will be zeroed out. For best accuracy, perform the zero on the hoist. Further discussion is in the zeroing section of this manual
	Angle Reference not set properly.	See “Angle reference incorrect” below
	Incorrect zero, direction of wheel rotation was changed during the zero procedure.	Be sure that the wheel is turned only in one direction during the zero procedure.
	External forces were imposed during the zero procedure on the hoist.	When turning the wheels, be sure to apply force only on the amplifier package. This insures that no forces are imposed through the sensor.
	Incorrect zero, on-the-road zero was performed on a rough surface.	Redo the zero procedure. For best accuracy, perform the zero on the hoist.
	Data acquisition system has some offset.	Using a volt meter, check the outputs from the CT2. If the outputs are indeed zero, null the offsets in the data acquisition system.
	CT2 electronics are damaged.	Swap the CT2 with another unit, if available, and try to zero it. If the problem goes away, send the CT2 electronics in for checkout and repair
Offsets are too large for the CT2 to zero them. Damage to sensor.	The wheel may have been damaged. Remove from the wheel and hub adapters and place on the bench. Change the CT2 to setup mode. Check the offset. If it is out of range, send in for checkout and repair.	

Symptom	Possible Causes	Solution
Outputs from CT2 stay zero for all channels even when force is present.	<p>CT2 is not turned on.</p> <p>Encoder has not found an index pulse.</p> <p>Signal cable from sensor has been disconnected.</p> <p>Signal Cable from sensor has been damaged.</p> <p>Output cable from the CT2 is disconnected or damaged.</p> <p>The data acquisition cabling is not connected improperly.</p>	<p>Check to see if the CT2 is turned on.</p> <p>The output channels stay at zero until the encoder sees an index pulse. Turn tire at least one complete revolution. Check outputs.</p> <p>Turn off the CT2 electronics, reconnect the cable and turn the CT2 electronics back on.</p> <p>Inspect cable for damage. A cable diagram is located in the appendix.</p> <p>Check connection and inspect cable for damage</p> <p>Check the output from the CT2 with a volt meter. If the output is correct, check the cabling or data acquisition setup.</p>
The channel offsets change during use.	<p>A severe event caused some shifting in the bolted joints between the sensor and adapters.</p> <p>A severe event overloaded the sensor.</p>	<p>While it is not common, a severe event could cause some offset in channels. Perform the zero sequence.</p> <p>Check the sensor offsets. Remove the wheel and hub adapters. Change the CT2 to Setup Mode Check the offsets for each channel with a voltmeter. If the offsets have changed, send the sensor in for checkout and possible repair.</p>

Symptom	Possible Causes	Solution
Higher or lower than expected output from one or more channels	<p>The data acquisition system sensitivities are incorrect.</p> <p>Incorrect Transducer ID dongle</p> <p>Sensor is damaged.</p> <p>Telemetry is damaged.</p>	<p>Check data acquisition system. The correct sensitivities are listed on the calibration sheet in the back of this manual.</p> <p>Check that the correct Transducer ID dongle is being used with the sensor.</p> <p>Check the sensor offsets and shunt values. Send in for checkout and repair if needed.</p> <p>Send in for checkout and repair if needed</p>
One or more output channels output incorrect polarity.	<p>Right/Left Switch is not in the correct position.</p> <p>Cable to data acquisition is improperly connected.</p> <p>Sensitivity is incorrect in the data acquisition system.</p> <p>Zero Angle not set properly</p>	<p>Check to see if switch is correct. Change if needed.</p> <p>Check the voltage from the CT2. If correct, check pin-out for signal cable to the data acquisition system.</p> <p>Check the voltage from the CT2. If correct, check the sensitivities in the data acquisition system.</p> <p>See "Angle reference incorrect" below</p>
Angle reference incorrect	Reference angle not set properly	Run the Zero Angle procedure and use an inclinometer to ensure that it is set properly.

Appendix 1

Wiring and Shielding

CT2 Analog *Signal Out* Connector Pin-Out

Circular 20 pin connector	
Pin Numbers	Function
1	Fx Low
2	Fx High
3	Fy Low
4	Fy High
5	Fz Low
6	Fz High
7	Mx Low
8	Mx High
9	My Low
10	My High
11	Mz Low
12	Mz High
13	Velocity Low
14	Velocity High
15	Position Low
16	Position High
17	Sine Low
18	Sine High
19	Cosine Low
20	Cosine High

CT2-TEL *Power Cable*

Mating Cable for Power:	
Black	Ground
White	Power High
Case	Shield/Ground

Transducer Calibration Quick Reference Sheets



MICHIGAN SCIENTIFIC
corporation

8500 Ance Road
Charlevoix, MI 49720
Phone: (231) 547-5511
Fax: (231) 547-7070
www.michsci.com

QUICK REFERENCE SHEET TRANSDUCER CALIBRATION

TRANSDUCER SERIAL NUMBER:

MSCLW-MC-3.5K-144

DATE:

April 5, 2013

Load Wheel Interface Electronics:

Gain and offset adjustments are handled in the Load Wheel Interface Electronics. The Interface uses a shunt calibration to calculate an appropriate gain so that the following sensitivities are correct. It is good practice to use the shunt feature to check the sensitivities internally in the Load Wheel Interface.

SENSITIVITY:

Fx: Sensitivity :	1 Volt =	400 lb	1,779 N
Fy: Sensitivity :	1 Volt =	160 lb	712 N
Fz: Sensitivity :	1 Volt =	400 lb	1,779 N
Mx: Sensitivity :	1 Volt =	160 lb-ft	217 N-m
My: Sensitivity :	1 Volt =	300 lb-ft	407 N-m
Mz: Sensitivity :	1 Volt =	160 lb-ft	217 N-m

With the supplied Michigan Scientific amplifiers this transducer would give an output of one volt, if the above load were applied. Two volts would mean that the applied load is twice the above value; minus one volt would mean the load is the value shown above, in the opposite direction, etc.

SHUNT CALIBRATION (FOR BEST ACCURACY):

Fx: Shunt=	3.867 V*	1,547 lb	6,881 N
Fy: Shunt=	6.397 V*	1,023 lb	4,553 N
Fz: Shunt=	3.676 V*	1,470 lb	6,540 N
Mx: Shunt=	6.611 V*	1,058 lb-ft	1,434 N-m
My: Shunt=	3.683 V*	1,105 lb-ft	1,498 N-m
Mz: Shunt=	6.521 V*	1,043 lb-ft	1,415 N-m

Although using transducer sensitivity to setup data-acquisition systems, is convenient, the accuracy of the values measured can be off by one percent or more due to normal variations in the data collection electronics. In order to correct for these variations, and get the most accurate data, Michigan Scientific recommends using a shunt calibration to check the sensitivities. To do this, perform a shunt sequence on the Load Wheel Interface Electronics. Record the outputs. Calculate the delta voltage (value from positive shunt to negative shunt) and divide by 2. Compare this number to the number listed above. The Load Wheel Interface makes adjustment so that the output is correct but variations may occur in the data collection system. You may find it necessary to adjust the recording equipment sensitivity for best accuracy.

* Shunt voltage listed is nominal, the actual voltage may vary.

SPEED AND POSITION

Velocity Sensitivity :	10 Volts =	2,000 RPM
Position Sensitivity :	10 Volts =	360 Degrees

Velocity is updated at each encoder pulse. Velocity in mph, or kph, can be calculated if the rolling radius is known.



QUICK REFERENCE SHEET
TRANSDUCER CALIBRATION

TRANSDUCER SERIAL NUMBER:

MSCLW-MC-3.5K-145

DATE:

April 5, 2013

Load Wheel Interface Electronics:

Gain and offset adjustments are handled in the Load Wheel Interface Electronics. The Interface uses a shunt calibration to calculate an appropriate gain so that the following sensitivities are correct. It is good practice to use the shunt feature to check the sensitivities internally in the Load Wheel Interface.

SENSITIVITY:

Fx: Sensitivity :	1 Volt =	400 lb	1,779 N
Fy: Sensitivity :	1 Volt =	160 lb	712 N
Fz: Sensitivity :	1 Volt =	400 lb	1,779 N
Mx: Sensitivity :	1 Volt =	160 lb-ft	217 N-m
My: Sensitivity :	1 Volt =	300 lb-ft	407 N-m
Mz: Sensitivity :	1 Volt =	160 lb-ft	217 N-m

With the supplied Michigan Scientific amplifiers this transducer would give an output of one volt, if the above load were applied. Two volts would mean that the applied load is twice the above value; minus one volt would mean the load is the value shown above, in the opposite direction, etc.

SHUNT CALIBRATION (FOR BEST ACCURACY):

Fx: Shunt=	3.869 V*	1,547 lb	6,883 N
Fy: Shunt=	6.362 V*	1,018 lb	4,528 N
Fz: Shunt=	3.877 V*	1,551 lb	6,897 N
Mx: Shunt=	6.583 V*	1,053 lb-ft	1,428 N-m
My: Shunt=	3.741 V*	1,122 lb-ft	1,522 N-m
Mz: Shunt=	6.578 V*	1,052 lb-ft	1,427 N-m

Although using transducer sensitivity to setup data-acquisition systems, is convenient, the accuracy of the values measured can be off by one percent or more due to normal variations in the data collection electronics. In order to correct for these variations, and get the most accurate data, Michigan Scientific recommends using a shunt calibration to check the sensitivities. To do this, perform a shunt sequence on the Load Wheel Interface Electronics. Record the outputs. Calculate the delta voltage (value from positive shunt to negative shunt) and divide by 2. Compare this number to the number listed above. The Load Wheel Interface makes adjustment so that the output is correct but variations may occur in the data collection system. You may find it necessary to adjust the recording equipment sensitivity for best accuracy.

* Shunt voltage listed is nominal, the actual voltage may vary.

SPEED AND POSITION

Velocity Sensitivity :	10 Volts =	2,000 RPM
Position Sensitivity :	10 Volts =	360 Degrees

Velocity is updated at each encoder pulse. Velocity in mph, or kph, can be calculated if the rolling radius is known.

Notes:

Notes: