

SENSOR DATA SHEET

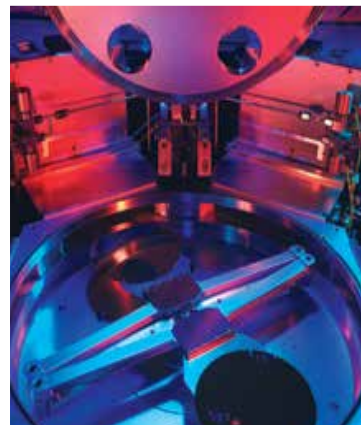

**DIT-5200L**

Noncontact differential impedance transducer

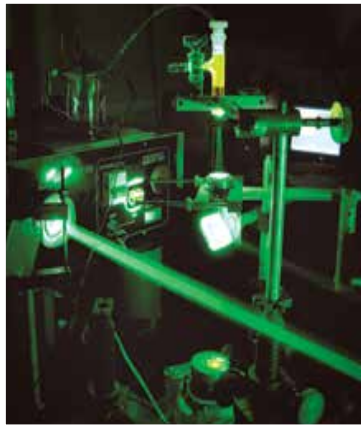

**Features**

- ❖ True differential for common mode rejection at an economical price
- ❖ High precision eddy current balanced bridge technology
- ❖ Capable of subnanometer resolution
- ❖ Thermal stability  $\pm.03\%$  FS/ $^{\circ}$ C, at null  $\pm.005\%$  FS/ $^{\circ}$ C
- ❖ Small package size: just 7.7 cubic inches
- ❖ High sensitivity: up to 10V/mil (39mV/ $\mu$ m)
- ❖ Extremely linear, to 0.1% full range
- ❖ Single and dual channel configurations



**Applications**

- ❖ Fast steering mirror
- ❖ Servo control position feed back
- ❖ Stage positioning
- ❖ Angular displacement indication
- ❖ X-Y orbit position feed back
- ❖ Stylus position

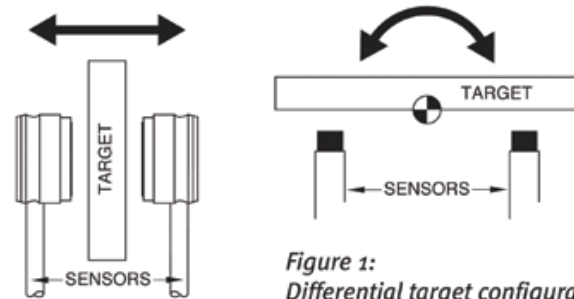

Figure 1: Differential target configurations

**Differential Measurements**

In an eddy current differential system, the two coils in the inductive bridge are housed in two separate sensors. Rather than one active coil and one reference coil, both sensors contain active coils as in figure 2. These two sensors are usually placed on opposite sides of a target or opposite sides of a target pivot point, as in figure 1.

**Theory of Operation**

As the target moves closer to one sensor, it moves away from the other, increasing the impedance in one leg of the inductive bridge, and decreasing the other. This push-pull effect amplifies the linear output-per-displacement and eliminates the need for summation amplifiers that add noise and drift. As a result, differential systems provide greater resolution and thermal stability than single-ended systems.

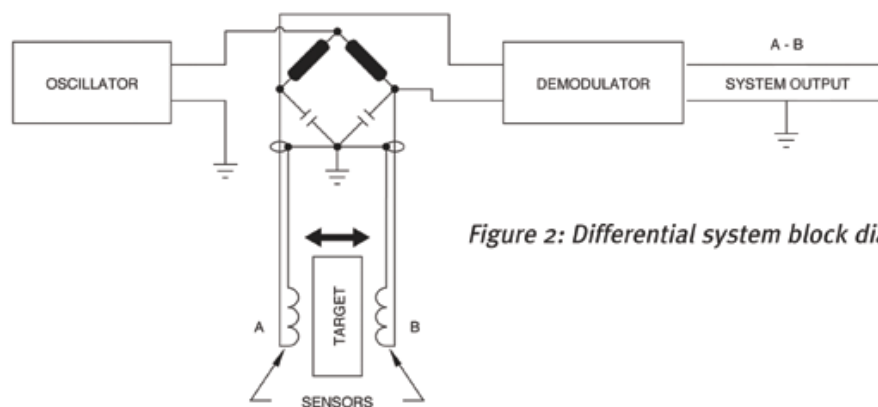

Figure 2: Differential system block diagram

**CALCULATING RESOLUTION**

**Equivalent RMS input noise:** A figure of merit used to quantify the noise contributed by a system component. It incorporates into a single value several factors that influence a noise specification such as signal-to-noise ratio, noise floor, and system bandwidth. Given a measuring system’s sensitivity/scale factor and the level of “white” noise in the system, equivalent RMS input noise can be expressed using actual measurement units.

**Effective resolution:** An application-dependent value determined by multiplying the equivalent RMS input noise specification by the square root of the measurement bandwidth.

Example: A 15N sensor monitoring a reciprocating target moving ±10 mils (FR) filtered externally to 15KHz bandwidth.

**1. Calculate a value for equivalent RMS input noise.**  
From the equivalent RMS input noise table, use the value of equivalent RMS input noise for a 15N sensor calibrated over a ±10 mil range. Multiply this by the full range of the calibration.  
Divide by 100. Noise value is a percent of full range.  
 $(0.00002\% \times 0.020 \text{ inches}) / 100 = 1.4 \times 10^{-8} \text{ inches or } 0.014 \text{ pinches.}$

**2. Calculate effective resolution.** From step 1, take the equivalent RMS input noise and multiply by the square root of the measurement bandwidth in Hz.  
 $0.014 \text{ pinches} \times \sqrt{15000} = 1.714 \text{ pinches}$

**3. Approximate peak-to-peak resolution.** From step 2, take the effective resolution and multiply by 6.6.  
 $1.714 \text{ pinches} \times 6.6 = 11.312 \text{ pinches}$

**EQUIVALENT RMS INPUT NOISE**

Range ± mils	Range ± mm	Sensor	% Full Range at Full Range	% Full Range at Null
10	0.25	15N	2E-5%	2E-5%
10	0.25	20N	2E-5%	2E-5%
20	0.50	15N	2E-5%	2E-5%
20	0.50	20N	2E-5%	2E-5%
35	0.90	15N	2E-5%	1E-5%
50	1.30	20N	2E-5%	1E-5%
75	1.90	20N	1.5E-5%	1E-5%

**SYSTEM SPECIFICATIONS  
(COMMON TO ALL)**

**Target material:** Aluminum

**Output voltage:** ±10 volts typical

**Power dissipation:**

At 15N sensor head: <0.5 mW/sensor typical.

At 20N sensor head: <2 mW/sensor typical.

Electronics: <1.35 Watts.

**Frequency response:** 0-20 kHz.

**Input voltage:** ±15 volts.

**Output impedance:** <1 Ohm.

**Weight:**

Electronics: 6 oz.

W/4 15N sensors: 8 oz.

**Operating temperature range:**

Electronics: +32°F to +140°F (0°C to +60°C).

Sensors: -62°F to +220°F (-52°C to +105°C).

**Storage temperature range:**

Electronics: -26°F to +180°F (-32°C to +82°C).

Sensors: -62°F to +220°F (-52°C to +105°C).

**MTBF (GB, 25°C):** >210,000 hours

**PERFORMANCE SPECIFICATIONS**

Range		Null		Sensor	Typical Non-Linearity ±%FR	Maximum Non-Linearity ±%FR	Typical Sensor TempCo ±%FR/°C	Resolution p-p%FR at 1 kHz BW at FR	Resolution p-p%FR at 1 kHz BW at Null
±mil	±mm	mil	mm						
10	0.25	15	0.38	15N	0.15%	0.30%	0.02%	0.004%	0.003%
20	0.50	25	0.64	15N	0.25%	0.50%	0.03%	0.003%	0.002%
35	0.90	40	1.02	15N	0.50%	1.00%	0.03%	0.003%	0.002%
10	0.25	20	0.51	20N	0.10%	0.20%	0.02%	0.004%	0.003%
20	0.50	40	1.02	20N	0.15%	0.30%	0.02%	0.004%	0.003%
50	1.30	60	1.52	20N	0.25%	0.50%	0.03%	0.003%	0.002%
75	1.90	85	2.16	20N	0.50%	1.00%	0.03%	0.003%	0.002%

Note: Full range (FR) is considered as twice the ±range value.  
Temperature coefficient at null <0.005% FR/°C typical.  
Performance specifications are based on aluminum target.

**DIT-5200L Differential Sensors and Electronics**

**15N SENSOR**

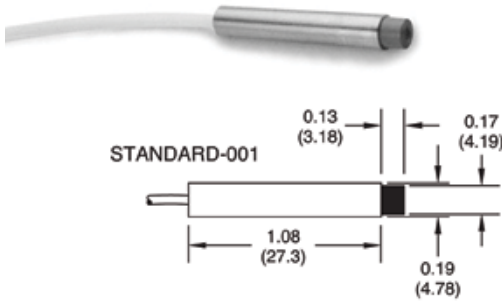

**OPTIONAL-002**

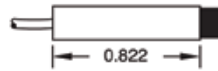

**OPTIONAL-003**

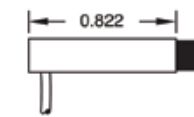

**OPTIONAL-004A**

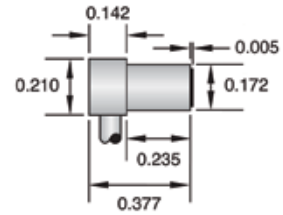

**20N SENSOR**

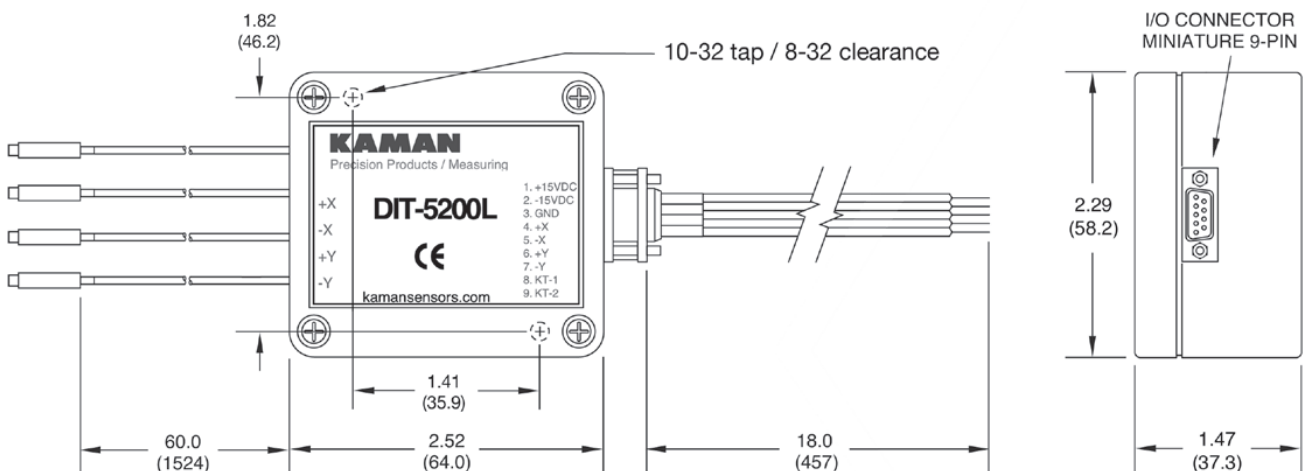
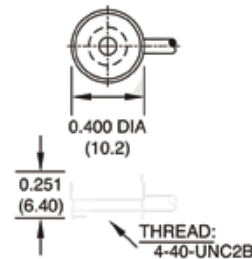

Note: All dimensions shown in inches (mm).  
Standard enclosure. Note: Single channel systems use the x axis sensor connectors.