

LIPS[®] S125 350 BAR SUBMERSIBLE STAND-ALONE LINEAR POSITION SENSOR

Position feedback for industrial and scientific applications

- **Non-contacting inductive technology to eliminate wear**
- **Travel set to customer's requirement**
- **Compact and self-contained**
- **High durability and reliability**
- **High accuracy and stability**
- **Sealing to IP68 350Bar**



As a leading designer and manufacturer of linear, rotary, tilt and intrinsically safe position sensors, Positek[®] has the expertise to supply a sensor to suit a wide variety of applications.

Our S125 LIPS[®] (Linear Inductive Position Sensor) is an affordable, durable, high-accuracy linear sensor designed for arduous underwater applications such as ROVs. The unit is highly compact and space-efficient, being responsive along almost its entire length. Like all Positek[®] sensors, the S125 provides a linear output proportional to travel. Each sensor is supplied with the output calibrated to the travel required by the customer, from 5 to 800mm and with full EMC protection built in. The sensor is very robust, the body and push rod being made of stainless steel for long service life and environmental resistance. Overall performance, repeatability and stability are outstanding over a wide temperature range. The sensor is easy to install with mounting options including stainless steel M8 rod eye bearings and body clamps. The push rod can be supplied free or captive, with male M8 thread, an M8 rod eye or dome end, captive push rods can be spring extended or retracted on sensors with up to 300mm of travel. The S125 also offers a wide range of mechanical and electrical options, environmental sealing is to IP68 350Bar.

SPECIFICATION

Dimensions	40 mm electronics & 35 mm calibrated travel + 184 mm
Body diameter	calibrated travel + 184 mm
Body length (Axial version)	calibrated travel + 189 mm
Body length (Radial version)	calibrated travel + 7 mm, OD 12.6 mm
Push rod extension	For full mechanical details see drawing S125-11
Independent Linearity	≤ ± 0.25% FSO @ 20°C - up to 450 mm
	≤ ± 0.5% FSO @ 20°C - over 450 mm
	≤ ± 0.1% FSO @ 20°C* available upon request.
*Sensors with calibrated travel from	10 mm up to 400 mm.
Temperature Coefficients	< ± 0.01%/°C Gain &
	< ± 0.01%FS/°C Offset
Frequency Response	> 10 kHz (-3dB)
	> 300 Hz (-3dB) 2 wire 4 to 20 mA
Resolution	Infinite
Noise	< 0.02% FSO
Environmental Temperature Limits (Non Icing)	
Operating	-4°C to +50°C
Storage	-4°C to +50°C
Sealing	IP68 350Bar
EMC Performance	EN 61000-6-2, EN 61000-6-3
Vibration	IEC 68-2-6: 10 g
Shock	IEC 68-2-29: 40 g
MTBF	350,000 hrs 40°C Gr
Drawing List	
S125-11	Sensor Outline
Drawings, in AutoCAD [®] dwg or dxf format, available on request.	

Do you need a position sensor made to order to suit a particular installation requirement or specification? We'll be happy to modify any of our designs to suit your needs - please contact us with your requirements.



LIPS[®] S125 350 BAR SUBMERSIBLE STAND-ALONE LINEAR POSITION SENSOR

Position feedback for industrial and scientific applications

How Positek's PIPS[®] technology eliminates wear for longer life

Positek's **PIPS[®]** technology (Positek Inductive Position Sensor) is a major advance in displacement sensor design. PIPS[®]-based displacement transducers have the simplicity of a potentiometer with the life of an LVDT/RVDT.

PIPS[®] technology combines the best in fundamental inductive principles with advanced micro-electronic integrated circuit technology. A PIPS[®] sensor, based on simple inductive coils using Positek's ASIC control technology, directly measures absolute position giving a DC analogue output signal. Because there is no contact between moving electrical components, reliability is high and wear is eliminated for an exceptionally long life.

PIPS[®] overcomes the drawbacks of LVDT technology – bulky coils, poor length-to-stroke ratio and the need for special magnetic materials. It requires no separate signal conditioning.

Our LIPS[®] range are linear sensors, while RIPS[®] are rotary units and TIPS[®] are for detecting tilt position. Ask us for a full technical explanation of PIPS[®] technology.

We also offer a range of ATEX-qualified intrinsically-safe sensors.

TABLE OF OPTIONS

CALIBRATED TRAVEL: Factory-set to any length from 5 to 810 mm in increments of 1mm.

ELECTRICAL INTERFACE OPTIONS

OUTPUT SIGNAL	SUPPLY INPUT	OUTPUT LOAD
Standard: 0.5-4.5V dc ratiometric	+5V dc nom. ± 0.5V.	5kΩ min.
Buffered: 0.5-4.5V dc	+24V dc nom. + 9-28V.	5kΩ min.
±5V dc	±15V dc nom. ± 9-28V.	5kΩ min.
0.5-9.5V dc	+24V dc nom. + 13-28V.	5kΩ min.
±10V dc	±15 V dc nom. ± 13.5-28V.	5kΩ min.
Supply Current	10mA typical, 20mA maximum.	
4-20mA (2 wire)	+24 V dc nom. + 18-28V.	300Ω @ 24V.
(3 wire sink)	+24 V dc nom. + 13-28V.	950Ω @ 24V.
(3 wire source)	+24 V dc nom. + 13-28V.	300Ω max.

CONNECTOR

Wet mate 4 pin MC BH-4-M (axial or radial)
Supplied with a connector and 0.5 m, 4x0.5mm² cable assembly as standard.
Mating connector with longer lengths available.

MOUNTING OPTIONS

M8 rod eye bearing (radial versions), Body Tube Clamp/s (axial or radial versions).

PUSH ROD OPTIONS – standard retained with M8x1.25 male thread, M8 rod eye bearing, Dome end, Spring extended or Free.

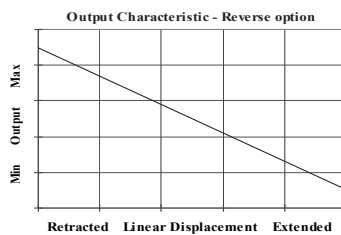
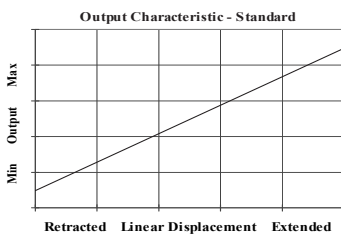

LIPS® SERIES S125 350 Bar Submersible Stand-Alone Linear Position Sensor

a	b	c	d	e	f	g	h		
S125	.	Displacement	Output	Connections	Option	Option	Option	Option	Z-code

a Displacement (mm)		Value
Displacement in mm	e.g. 0 - 254 mm	254
b Output		
Supply V dc V _s (tolerance)	Output	Code
+5V (4.5 - 5.5V)	0.5 - 4.5V (ratiometric with supply)	A
±15V nom. (±9 - 28V)	±5V	B
+24V nom. (13 - 28V)	0.5 - 9.5V	C
±15V nom. (±13.5 - 28V)	±10V	D
+24V nom. (18 - 28V)	4 - 20mA 2 wire	E
+24V nom. (13 - 28V)	4 - 20mA 3 wire Sink	F
+24V nom. (9 - 28V)	0.5 - 4.5V	G
+24V nom. (13 - 28V)	4 - 20mA 3 wire Source	H
c Connections		Code
Connector - Axial	IP68 350 Bar Wet mate 4 pin MC	J50
Connector - Radial	BH-4-M plus pre-wired mating connector	K50
d Body Fittings		Code
None - default		blank
M8 Rod-eye Bearing	Radial body style only	N
Body Clamps - 1 pair		P
Body Clamps - 2 pairs		P2
e Sprung Push Rod		Code
None - default		blank
Spring Extend	Up to 300mm displacement.	R
Spring Retract	Captive push rod only.	S
f Push Rod Fittings		Code
None - default	Male Thread M8x1.25x10.5 long	blank
Dome end	Required for option 'R'	T
M8 Rod-eye Bearing		U
g Push Rod Options		Code
Captive - default	Push rod is retained	blank
Non-captive	Push rod can depart body	V
h Z-code		Code
≤± 0.1% @20°C Independent Linearity displacement between 10mm & 400mm only!		Z650



Installation Information

LIPS® S125 350 BAR SUBMERSIBLE STAND-ALONE LINEAR POSITION SENSOR

Output Option	Output Description:	Supply Voltage: V_s (tolerance)	Load resistance: (include leads for 4 to 20mA O/Ps)
A	0.5 - 4.5V (ratiometric with supply)	+5V (4.5 - 5.5V)	$\geq 5k\Omega$
B	$\pm 5V$	$\pm 15V$ nom. ($\pm 9 - 28V$)	$\geq 5k\Omega$
C	0.5 - 9.5V	+24V nom. (13 - 28V)	$\geq 5k\Omega$
D	$\pm 10V$	$\pm 15V$ nom. ($\pm 13.5 - 28V$)	$\geq 5k\Omega$
E	4 - 20mA 2 wire Current Loop	+24V nom. (18 - 28V)	$\approx 0 - 300\Omega$ max. @24V ~ 1.2 to 6V across 300 Ω $\{R_L \text{ max.} = (V_s - 18) / 20^{-3}\}$
F	4 - 20mA 3 wire Sink	+24V nom. (13 - 28V)	$\approx 0 - 950\Omega$ max. @24V ~ 3.8 to 19V across 950 Ω $\{R_L \text{ max.} = (V_s - 5) / 20^{-3}\}$
G	0.5 - 4.5V	+24V nom. (9 - 28V)	$\geq 5k\Omega$
H	4 - 20mA 3 wire Source	+24V nom. (13 - 28V)	$\approx 0 - 300\Omega$ max. ~ 1.2 to 6V across 300 Ω

Connector Pin Layout:
MC BH 4 M (face view)

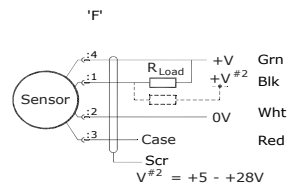
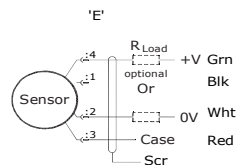
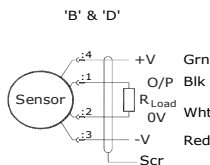
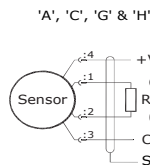

Mechanical Mounting: Depending on options; Body can be mounted by M8 rod eye or by clamping the sensor body - body clamps are available, if not already ordered. Target by M8x1.25 male thread or M8 rod eye. It is assumed that the sensor and target mounting points share a common earth.

N.b. cable free end must be appropriately terminated to prevent water ingress into the cable. **See page 2 for connector handling instructions.**
The sensor is sealed to IP68 350 Bar.

Output Characteristic: Target is extended 7 mm from end of body at start of normal travel. The output increases as the target extends from the sensor body, the calibrated stroke is between 5 mm and 800 mm.

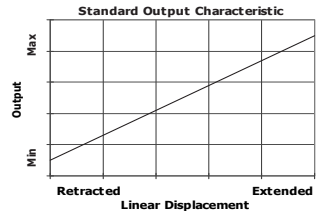

Incorrect Connection Protection levels:-

- A** **Not protected** – the sensor is **not** protected against either reverse polarity or over-voltage. The risk of damage should be minimal where the supply current is limited to less than 50mA.
- B & D** Supply leads diode protected. Output must not be taken outside $\pm 12V$.
- C & G** Supply leads diode protected. Output must not be taken outside 0 to 12V.
- E, F & H** Protected against any misconnection within the rated voltage.



Installation Information

LIPS® S125 350 BAR SUBMERSIBLE STAND-ALONE LINEAR POSITION SENSOR

Handling

- Always apply grease before mating
- Disconnect by pulling straight, not at an angle
- Do not pull on the cable and avoid sharp bends at cable entry
- When using a bulkhead connector, ensure that there are no angular loads
- Do not over-tighten the bulkhead nuts
- SubConn® connectors should not be exposed to extended periods of heat or direct sunlight. If a connector becomes very dry, it should be soaked in fresh water before use

Greasing and mating above water (dry mate)

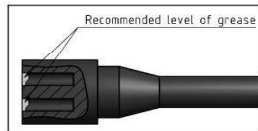

- Connectors must be greased with Molykote 44 Medium before every mating
- A layer of grease corresponding to minimum 1/10 of socket depth should be applied to the female connector
- The inner edge of all sockets should be completely covered, and a thin transparent layer of grease left visible on the face of the connector
- After greasing, fully mate the male and female connector in order to secure optimal distribution of grease on pins and in sockets
- To confirm that grease has been sufficiently applied, de-mate and check for grease on every male pin. Then re-mate the connector

Greasing and mating under water (wet mate)

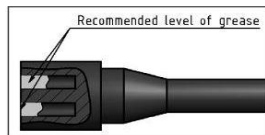

- Connectors must be greased with Molykote 44 Medium before every mating
- A layer of grease corresponding to approximately 1/3 of socket depth should be applied to the female connector
- All sockets should be completely sealed, and transparent layer of grease left visible on the face of the connector
- After greasing, fully mate the male and female connector and remove any excess grease from the connector joint

Cleaning

- General cleaning and removal of any accumulated sand or mud on a connector should be performed using spray based contact cleaner (isopropyl alcohol)
- New grease must be applied again prior to mating

N.b. ROD-EYE ORIENTATION NOT GUARANTEED.
 CONNECTORS; MICRO MINI WETMATE, 4-POLE.
 BULKHEAD; MCBH-4-MP-SS, STAINLESS STEEL/MOLDED NEOPRENE, SEALING; 340 BAR OPEN FACE, 600 BAR MATED.
 IN-LINE; MCIL-4-FS, MOLDED NEOPRENE WITH CABLE. LOCKING SLEEVE; MCDLS-F, DELRIN.

ELECTRICAL OPTIONS/ SPECIFICATIONS

OUTPUT OPTION	SUPPLY	
A	0.5 TO 4.5V RATIOMETRIC	5V
B	±5V	±15V
C	0.5 TO 9.5V	24V
D	±10V	±15V
E	0.5 TO 4.5V	24V
F	SUPPLY CURRENT 12mA TYP. 20mA MAX.	24V
G	4 TO 20mA 2-WIRE	24V
H	4 TO 20mA 3-WIRE SINK	24V
	4 TO 20mA 3-WIRE SOURCE	24V

STANDARD
 BUFFERED

SINK VERSION OUTPUT COMPLIANCE 5-28V
 SOURCE VERSION DRIVE 300Ω MAX TO 0V

MATING CONNECTOR (CODE 'J50' OR 'K50') SUPPLIED WITH 50cm MOULDED CABLE AS STANDARD.
 4-CORE SCREENED: 0.5mm², ø7.5mm MAX. JACKET AND CORE INSULATION: EPDM.

CONNECTIONS:-

- 1 BLACK OUTPUT
- 2 WHITE 0V
- 3 RED BODY (OPTIONS: A, C, E-H)
-Ve (OPTIONS: B OR D)
- 4 GREEN +Ve
SCREEN NOT CONNECTED TO SENSOR

RANGE OF DISPLACEMENT FROM 0-5mm TO 0-800mm e.g.76mm, IN INCREMENTS OF 1mm.

BODY MATERIAL: STAINLESS STEEL 316.

FURTHER OPTIONS:

- SINGLE PAIR OF BODY CLAMPS 'P'
- TWO PAIRS OF BODY CLAMPS 'P2'

- SPRING RETURN PUSH-ROD, TRAVEL ≤300mm
- RETURN TO EXTENDED POSITION (CODE R)
- RETURN TO RETRACTED POSITION (CODE S)
- PUSH-ROD FREE (CODE 'V') - NOT AVAILABLE WITH SPRUNG OPTIONS.

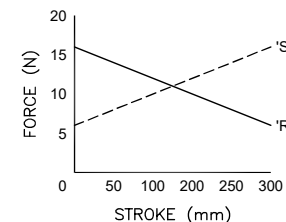
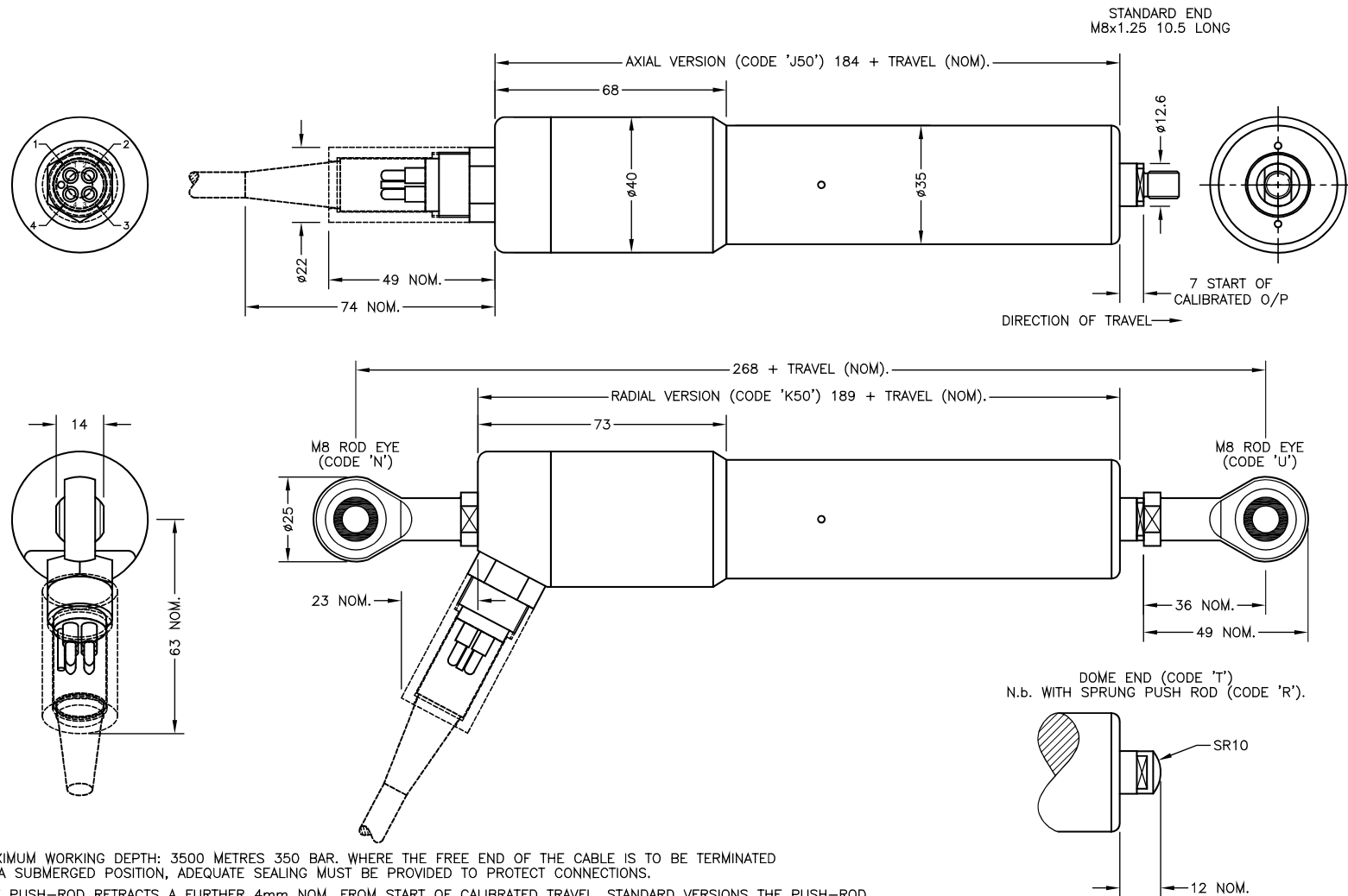

MAXIMUM WORKING DEPTH: 3500 METRES 350 BAR. WHERE THE FREE END OF THE CABLE IS TO BE TERMINATED IN A SUBMERGED POSITION, ADEQUATE SEALING MUST BE PROVIDED TO PROTECT CONNECTIONS.

THE PUSH-ROD RETRACTS A FURTHER 4mm NOM. FROM START OF CALIBRATED TRAVEL. STANDARD VERSIONS THE PUSH-ROD EXTENDS A FURTHER 8mm NOM. FROM END OF CALIBRATED TRAVEL, FOR SPRUNG VERSIONS: 'R': 1mm, 'S': 2mm.
 'V' CODED PUSH-ROD WILL DEPART SENSOR BODY.

C	CONNECTION 3 AMENDED - RAN1117	PDM
D	"7 START OF..." WAS "7.00 START OF..."	PDM
E	MALE M8 WAS FEMALE RAN1180	RDS
F	CABLE COLOURS CORRECTED - RAN1190	PDM
G	3500 METERS WAS 3482 RAN1145	RDS
H	RANGE NOTE AMENDED ~ RAN1200	PDM



DRAWINGS NOT TO BE CHANGED WITHOUT REFERENCE TO THE CHANGE PROCEDURE.
 CHANGES TO PARTS USED IN INTRINSICALLY SAFE PRODUCT MUST BE APPROVED BY THE AUTHORISED PERSON
 THIS IS AN UNCONTROLLED PRINT AND WILL NOT BE UPDATED.



C	16/09/16		CHECKED BY	X	±0.4
D	21/10/16		RDS	X.X	±0.2
E	25/4/17			X.XX	±0.1
F	14/06/17			DIMS	mm
DESCRIPTION		S125 350 BAR SUBMERSIBLE STAND-ALONE LINEAR POSITION SENSOR			
G	15/06/17				
H	12/09/17				
SCALE	12.5mm	DRAWING NUMBER	S125-11	REV	H
		SHEET 1 OF 1			