

GL2000

midi LOGGER HV

USER'S MANUAL

MANUAL NO.GL2000-UM-151

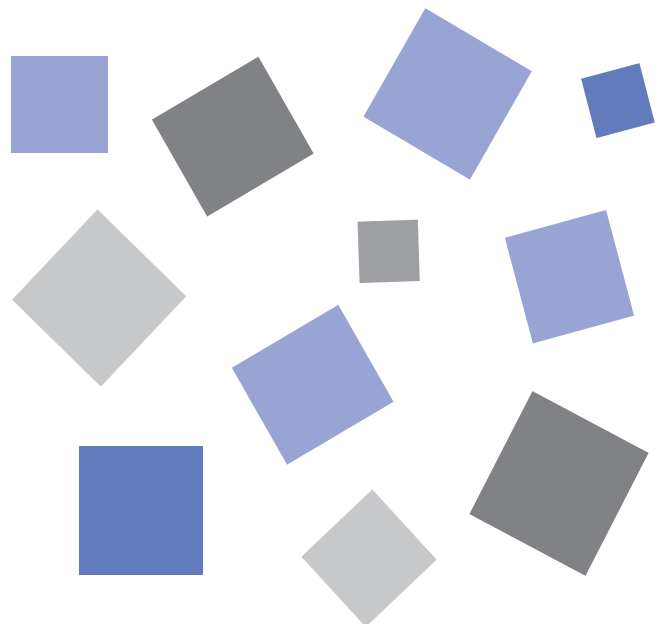





GRAPHTEC

To Ensure Safe and Correct Use









- To ensure safe and correct use of this device, read this manual thoroughly before use.
- After having read this manual, keep it in a handy location for quick reference as needed.
- Do not permit small children to touch this device.
- The following describes important points for safe operation. Please be sure to observe them strictly.

Conventions Used in This Manual

To promote safe and accurate use of this device as well as to prevent human injury and property damage, safety precautions provided in this manual are ranked into the five categories described below. Be sure you understand the difference between each of the categories.

 DANGER	This category provides information that, if ignored, is highly likely to cause fatal or serious injury to the operator.
 WARNING	This category provides information that, if ignored, is likely to cause fatal or serious injury to the operator.
 CAUTION	This category provides information that, if ignored, could cause physical damage to this device.
 HIGH TEMPERATURE	This category provides information that, if ignored, is likely to cause burns or other injury to the operator due to contact with high temperature.
 ELECTRICAL SHOCK	This category provides information that, if ignored, is likely to expose the operator to electrical shock.

Description of Safety Symbols

	The  symbol indicates information that requires careful attention (including warnings). The specific point requiring attention is described by an illustration or text within or next to the  symbol.
	The  symbol indicates an action that is prohibited. Such prohibited action is described by an illustration or text within or next to the  symbol.
	The  symbol indicates an action that must be performed. Such imperative action is described by an illustration or text within or next to the  symbol.

Introduction

Thank you for purchasing the GL2000 midi LOGGER HV.

Please read this manual thoroughly before attempting to use your new product to ensure that you use it correctly and to its full potential.

Notes on Use

Be sure to read all of the following notes before attempting to use the GL2000 midi LOGGER HV.

1. Note on the CE Marking

The GL2000 midi LOGGER HV complies with the following standards.

- EN 61326-1 Class A standard based on the EMC directive (2014/30/EU)
- EN 61010-1:2010 3rd standard based on the LVD directive (2014/35/ EU)

Although the GL2000 complies with the above-mentioned standards, be sure to use it correctly in accordance with the instructions and notes provided in this manual.

Moreover, use of the GL2000 by incorrect procedures may result in damage to the GL2000 or may invalidate its safeguards. Please confirm all of its notes regarding use and other related information to ensure correct use.

2. Warning

This is a Class A product according to the EMC directive. In a domestic environment, this product may cause radio interference or may be affected by radio interference to the extent that proper measurement cannot be performed.

3. Notes for Safe Operation

- (1) Be sure to use the Graphtec-supplied AC adapter. In environments where there is a lot of noise or where the power supply is unstable, we recommend that you ground the GL2000.
- (2) When a high-voltage signal cable has been connected to the main unit's analog signal input terminal, avoid touching the leads of the input terminal's signal cable to prevent electrical shock due to high voltage.
- (3) Ensure that the GL2000 power source is positioned so that it can easily be disconnected.
- (4) Do not input the voltage that exceeds the specification of this device.
 - If a voltage exceeding the specified value is connected, the semiconductor relay in the input section will get damaged. Never input a voltage exceeding the specified value even for a moment. It will cause a fire.
 - Have an enough margin from the specification of withstanding voltage when using this device, it have to consider a noise and change in measurement voltage.
 - Confirm that the device is not damaged before the input cable is connected to the input terminal.
 - Please take care of static electricity when connecting an input cable or a thermocouple.
 - Do not touch the tip of thermocouples with bare hand after the thermocouples are connected to the terminal of this device if the tip of thermocouples is not insulated.
The static electricity from a human body will cause damage to the device.
 - Do not put the tip of thermocouples to an object which contains static electricity if the tip of thermocouples is not insulated. The static electricity of object will cause damage to this device.
 - Do not put the tip of thermocouples to an object which contains leaked high voltage of chassis or metal etc. if the tip of thermocouples is not insulated.
The leaked high voltage from object will cause damage to the device.
 - We recommend that the insulation tape puts on the tip of thermocouples before connecting the thermocouples to the input terminals.
This will protect this device from the static electricity and the leaked high voltage.

4. Notes on Functions and Performance

- (1) Be sure to connect the main unit to an AC or DC power supply that conforms to the rated range.
Connecting the device to a non-rated power supply may cause the main unit to overheat and break down.
- (2) Do not block the vent on the main unit.
Continued operation with the blocked vent may cause the main unit to overheat and break down.
- (3) To avoid malfunctions and other damage, avoid using GL2000 in the following locations.
 - Places exposed to high temperature and/or high humidity, such as in direct sunlight or near heating equipment.
Allowable temperature range: 0 to 40°C (When AC adapter or battery is operated)
: 15 to 25°C (Battery being charged)
 - Allowable humidity range: 5 to 85%R.H., non-condensing
 - Locations subject to excessive salt spray or heavy fumes from corrosive gas or solvents.
 - Excessively dusty locations.
 - Locations subject to strong vibrations or shock.
 - Locations subject to surge voltages and/or electromagnetic interference.
- (4) If the main unit becomes soiled, wipe clean using a soft, dry cloth. Use of organic solvents (such as thinner or benzene) causes deterioration and discoloration of the outer casing.
- (5) Do not use GL2000 in the vicinity of other devices which are susceptible to electromagnetic interference.
- (6) Measured results may not conform to the stated specifications if GL2000 is used in an environment which is subject to strong electromagnetic interference.
- (7) Insofar as possible, position GL2000 input signal cables away from any other cables which are likely to be affected by electromagnetic interference.
- (8) For stabilized measurement, allow GL2000 to warm up for at least 30 minutes after turning the power on.

Notes on the Use of This Manual

- (1) All rights reserved. No part of this publication may be reproduced, stored in a retrieval system, or transmitted, in any form or by any means, without the prior written permission of Graphtec Corporation.
- (2) The specifications and other information in this manual are subject to change without notice.
- (3) While every effort has been made to supply complete and accurate information about this product, please address any inquiries about unclear information, possible errors, or other comments to your sales representative or nearest Graphtec vendor.
- (4) Notwithstanding the preceding paragraph, Graphtec Corporation assumes no liability for damages resulting from the use of the information contained herein or of the product.

About Registered Trademarks

Microsoft and Windows are registered trademarks or trademarks of Microsoft Corporation in the U.S. and elsewhere.

Other company names and product names included in this manual are registered trademarks or trademarks of their respective companies.

Copyright

All copyrights regarding this manual belong to Graphtec Corporation.

CONTENTS

To Ensure Safe and Correct Use	i
Introduction	i
Notes on Use	i
Notes on the Use of This Manual	iii
About Registered Trademarks	iii
Copyright	iii

CHAPTER 1 General Description

1.1 Overview	1-2
1.2 Features	1-2
1.3 Operating Environment	1-3
Ambient Operating Conditions	1-3
Warming-up Before Use	1-3
Configuration When in Use	1-4
1.4 Rubber Protector	1-5
1.5 Notes on Temperature Measurement	1-6
1.6 Notes on Using the Monitor	1-6
1.7 Changing the Display Language	1-6

CHAPTER 2 Checks and Preparation

2.1 Checking the Outer Casing	2-2
2.2 Checking for Accessories	2-2
Standard Accessories	2-2
2.3 Nomenclature and Functions	2-3
2.4 How to attach the tilt stand	2-4
2.5 How to detach the rubber protector	2-5
How to attach the rubber protector	2-5
How to remove the rubber protector	2-6
2.6 Connecting the Power Cable and Turning the Power on	2-7
2.7 Connecting the Input Signal Cables	2-9
2.8 Logic Alarm Cable Connection and Functions	2-11
2.9 Mounting the SD Card	2-15
2.10 Installing USB Memory	2-17
2.11 Connecting to a PC	2-18
2.12 Using the Battery Pack (B-569 : Option)	2-20
2.13 Connecting the Humidity Sensor	2-23
2.14 Precautions to Observe When Taking Measurement	2-24
2.15 Noise Countermeasures	2-26
2.16 When Fixing This Device	2-27
2.17 Setting the Date and Time	2-28

CHAPTER 3 Settings and Measurement

3.1	Window names and functions	3-2
3.2	Key Operation	3-17
3.3	Description of the display mode	3-27
	(1) Y-T waveform display	3-27
	(2) Logging display/real time statistical calculation display	3-37
	(3) XY waveform display	3-39
3.4	Operation Modes	3-52
3.5	Setting Menus	3-56
	(1) AMP settings	3-56
	(2) DATA settings	3-69
	(3) DISP settings	3-82
	(4) TRIG settings	3-94
	(5) Interface settings	3-105
	(6) OTHER settings	3-112
	(7) FILE menu	3-118
	(8) Data replay menu	3-130
3.6	WEB Server Function	3-134
3.7	List of Error Codes	3-139

CHAPTER 4 Specification

4.1	Standard Specifications	4-2
	Internal RAM	4-3
	Internal memory	4-3
	USB Memory slot	4-3
	SD card	4-3
	PC I/F	4-4
	Monitor	4-4
	Input section	4-5
4.2	Function Specifications	4-7
	Function Specificationsr	4-7
	Trigger Functions	4-8
	Alarm Functions	4-8
	External Input/Output Functions	4-9
4.3	Accessories/Optional Accessories	4-10
	Control Software	4-10
	Standard Accessories	4-10
	Battery Pack (Option)	4-10
	List of Options	4-11
4.4	External Dimensions	4-12

INDEX	I-1
--------------------	------------

CHAPTER 1 General Description

This chapter provides a general description of this device and its features.

PRODUCT SUMMARY

- 1.1 Overview***
- 1.2 Features***
- 1.3 Operating Environment***
- 1.4 Rubber Protector***
- 1.5 Notes on Temperature Measurement***
- 1.6 Notes on Using the Monitor***
- 1.7 Changing the Display Language***

1.1 Overview

GL2000 is a compact, lightweight, multi-CH, and multi-purpose data logger with a 7-inch color display.

GL2000 can capture up to DC \pm 600V or AC 600V with maximum 1 μ s sampling.

Large capacity of measured data can be saved directly in the internal memory, SD card, or USB memory.

As PC interface is equipped with USB and Ethernet, the system can be configured in accordance to application environment. Since it is equipped with the WEB server and the FTP server as part of the Ethernet function, you can monitor and transfer data remotely.

1.2 Features

Input

- Using M3.5 screw terminal or BNC terminal, input terminal can easily be wired.
- Can measure voltage, temperature, effective value (RMS).

Display & Operation

- With this device's high-resolution 7-inch TFT color liquid crystal display, you can confirm the waveforms of measured data and channel settings at a glance.
- Easy operation is achieved through a straightforward menu structure and key allocation which resembles a mobile phone.

Data Capture

- This device can capture at up to 1 μ s capturing interval to the Internal RAM .
- Measure for an extended period at high speed to the Internal RAM with 4M word per CH.
It is useful the Internal RAM can be divided up to 8 segments to repeat measurement in continuous mode.
- It can to capture up to 4GByte data to the internal memory, SD memory card and USB memory.
- Large capacity of measured data can be saved directly into the internal memory, SD card, or USB memory.
- Using SD card or USB memory as additional memory, measure for an extended period while backing the data up for additional storage media.
- The new ring memory capture function maintains latest data even after capturing for a long term. (You need to set how long you want to keep the data.)
- GL2000 is equipped with the relay capturing function, and 4GByte or more data can be saved by switching the to the other file without missing any data.

Data Control & Processing

- The application software lets you set conditions and monitor data on a PC in real time.
- With the USB drive mode function, you can recognize the GL2000 internal memory and SD card as an external drive from a PC.
(Connect the GL2000 to the PC and turn the GL2000 power while holding down the [START] key.)
- The FTP client function enables backup of measurement data to the FTP server.
- The WEB server function enables control and monitoring from a remote location without using dedicated software.
- The NTP client function enables synchronization of the time with the NTP server.

1.3 Operating Environment

This section explains the operating environment for this device.

Ambient Operating Conditions

(1) Ambient temperature and humidity (Use within the following range.)

- Temperature range: 0 to 40°C (When AC adapter or battery is operated)
: 15 to 25°C (Battery being charged)

- Humidity range: 5 to 85% R.H. (non-condensing)

(2) Environment (Do not use in the following conditions.)

- A Location exposed to direct sunlight
- Locations exposed to salty air, corrosive gases, or organic solvents
- Dusty locations
- Locations subject to vibration or impact
- Locations subject to voltage surge or electromagnetic interference such as lightning or electric furnaces

(3) Installation category (over-voltage category)

- This device belongs to Installation Category II defined in IEC60664-1.
- Never use this device for Installation Category III or IV.

(4) Measurement category

- This device is available for Measurement category III.
- This device is not available for Measurement category IV.



● **If condensation occurs...**

Condensation occurs in the form of water droplets on the device surfaces and interior when this device is moved from a cold to a warm location. Using this device with condensation will cause malfunctioning. Wait until the condensation has disappeared before turning the power on.

Warming-up Before Use

This device should be allowed to warm up with the power turned on for approximately 30 minutes to ensure that it operates according to the specified performance.

Configuration When in Use

When using the device, be sure to set the device vertically, or use the tilt foot and tilt stand to operate the device.

<Usage Configuration>

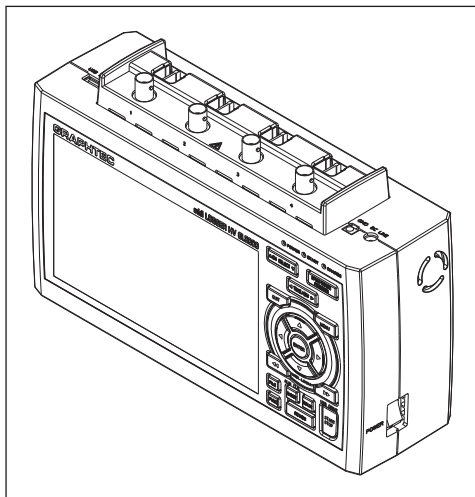

Vertical state

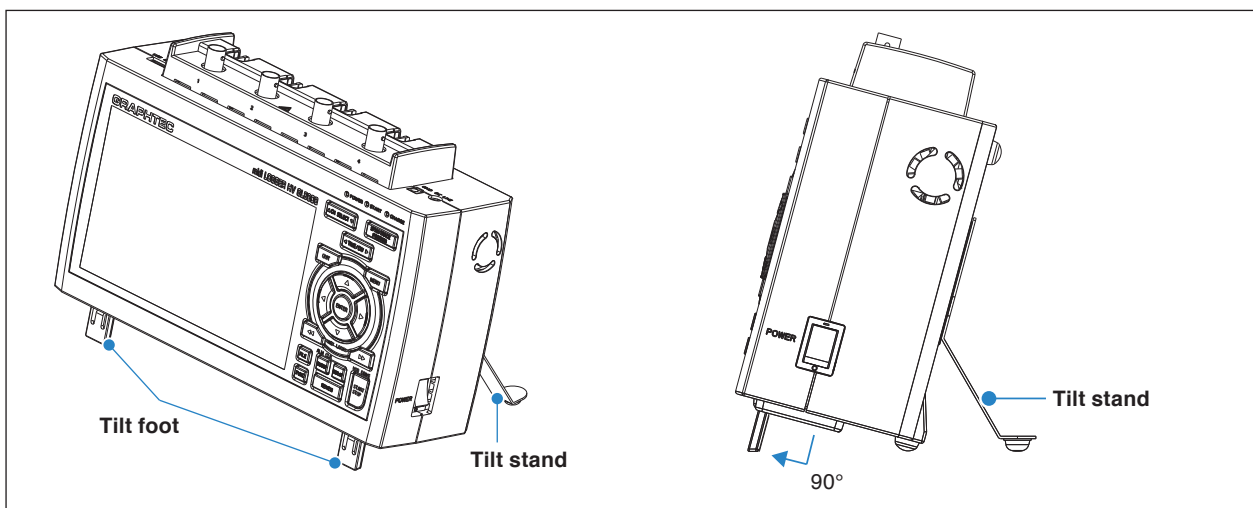

Inclined state

CAUTION

- Do not block the air vent on this device, as this will cause malfunctioning.
 - Measurement accuracy may not be accurate if the system is used in a condition other than described above.
 - If using this device in a tilted state, please use both tilt foot and tilt stand for this device to prevent it from falling.
-

1.4 Rubber Protector

To remove a battery pack, remove the rubber protector first.

This manual describes in the state without the rubber protector.

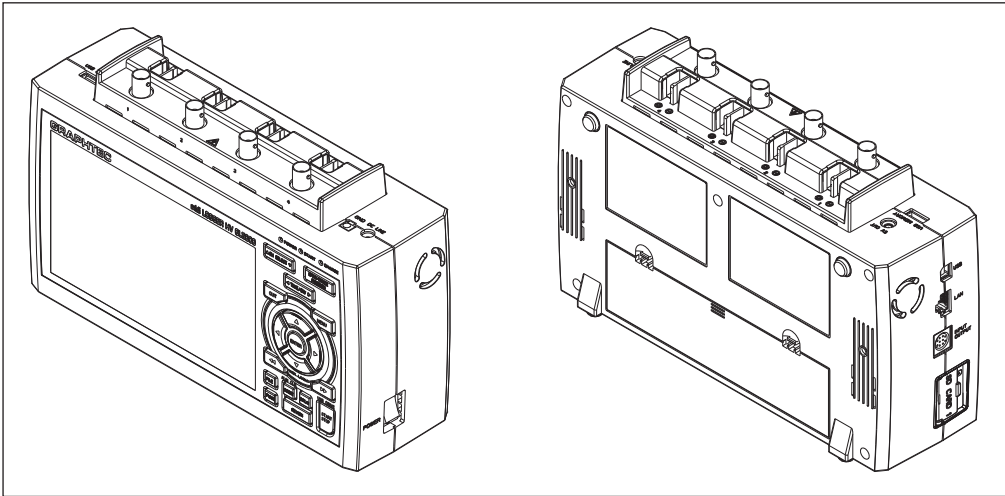

Without rubber protector

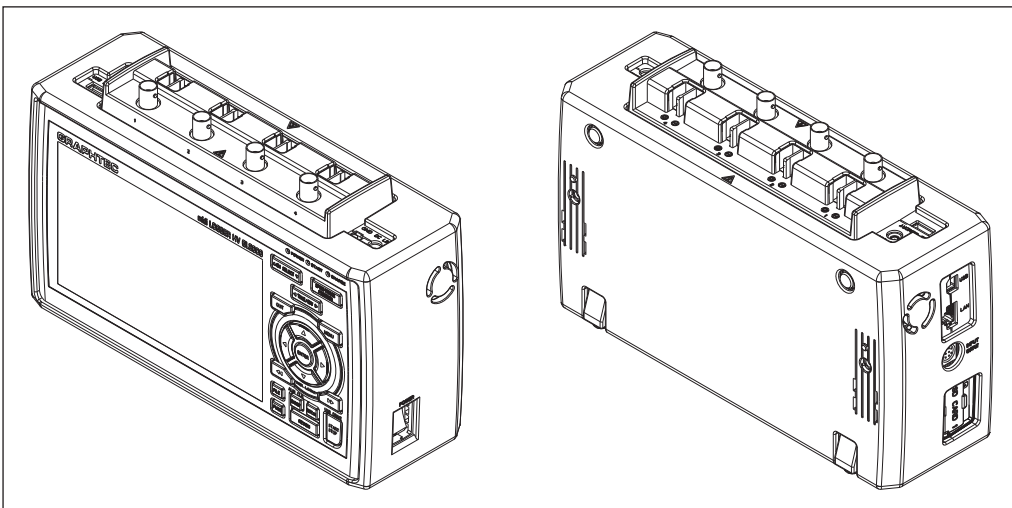

With rubber protector

1.5 Notes on Temperature Measurement

Please observe the following precautions when taking temperature measurement.

- Do not block the air vents. Always provide a space of at least 30 cm on all sides of this device.
- For stabilized temperature measurement, allow this device to warm up for at least 30 minutes after turning the power on.
- Exposure of the input terminals to direct drafts, direct sunlight, or abrupt changes in temperature may impair the equilibrium of the input parts and result in measurement errors. To measure temperature in such an environment, take appropriate countermeasures such as changing the installation site of this device or properly ground the equipment.
- To conduct measurement in noisy environments, connect this device's GND terminal to ground (Refer to "2.15 Noise Countermeasures").
- If the measured value fluctuates due to noise, set FILTER to other than OFF in the input setting menu of this device.

1.6 Notes on Using the Monitor

The monitor is an LCD display unit. The display will vary depending on the operating environment.

CHECKPOINT

If a screen saver function is used, it will operate and clear the screen if no operations are performed during the preset time. When pressing any of the operation keys, the screen saver is released and the screen display is started.

CAUTION

- Condensation may form on the LCD screen if this device is moved from a cold to a warm location. If this occurs, wait until the LCD screen warms up to room temperature.
- The LCD screen is manufactured to extremely high precision. Black dots may appear, or red, blue, and green dots may appear. Likewise, lines may appear when viewed from certain angles. These phenomena are due to the LCD screen construction, and are not signs of a defect.

1.7 Changing the Display Language

You can select the language displayed on the screen. The default display language is set to English for worldwide market. To change the display language, see the instructions in "OTHER:Language".



CHAPTER 2 Checks and Preparation

This chapter provides how to check the device's external casing and accessories, and how to prepare the device for operation.

PRODUCT SUMMARY

- 2.1 *Checking the Outer Casing*
- 2.2 *Checking for Accessories*
- 2.3 *Nomenclature and Functions*
- 2.4 *How to attach the tilt stand*
- 2.5 *How to detach the rubber protector*
- 2.6 *Connecting the Power Cable and Turning the Power on*
- 2.7 *Connecting the Input Signal Cables*
- 2.8 *Logic Alarm Cable Connection and Functions*
- 2.9 *Mounting the SD Card*
- 2.10 *Installing USB Memory*
- 2.11 *Connecting to a PC*
- 2.12 *Using the Battery Pack (B-569 : Option)*
- 2.13 *Connecting the Humidity Sensor*
- 2.14 *Precautions to Observe When Taking Measurement*
- 2.15 *Noise Countermeasures*
- 2.16 *When Fixing This Device*
- 2.17 *Setting the Date and Time*

2.1 Checking the Outer Casing

After unpacking, check this device's outer casing before use. In particular, please check for the following:

- Surface scratches
- Other flaws such as stains or dirt

2.2 Checking for Accessories

After unpacking, check that the following standard accessories are included.

Standard Accessories

Item	Remarks	Quantity
Quick Start Guide	GL2000-UM-85x	1
CD-ROM	User's Manual, Application software	1
TO ENSURE SAFE AND CORRECT USE	SAFETY PAMPHLET	1
AC cable/AC adapter	100 to 240 VAC, 50/60 Hz	1
Ferrite core	For attaching each cable	3
M3.5 Flat screw	For thin-type thermocouple	10
Tilt stand	Tilt stand x2, M4 x 5 screw 2, M4x8 screw 2, specerx3	1

2.3 Nomenclature and Functions

This section describes the names and function of the device.

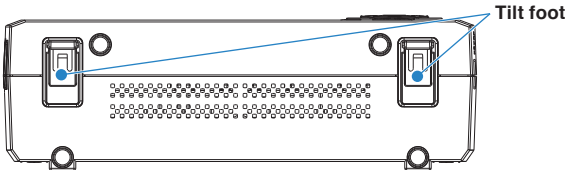
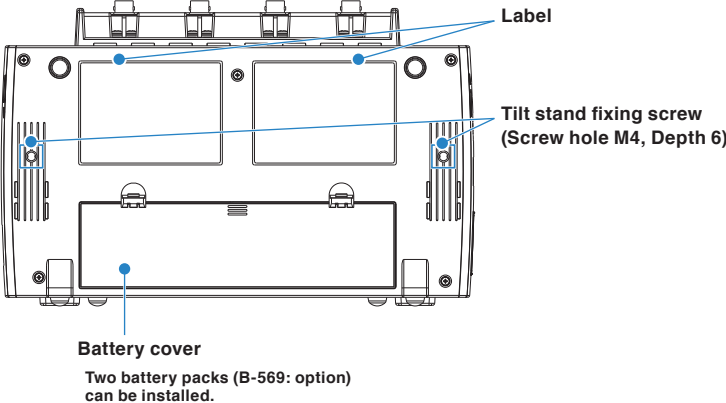
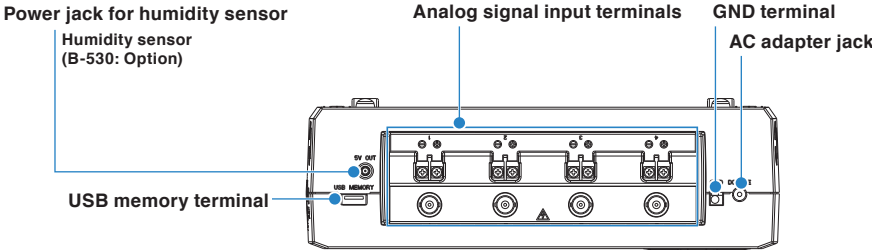
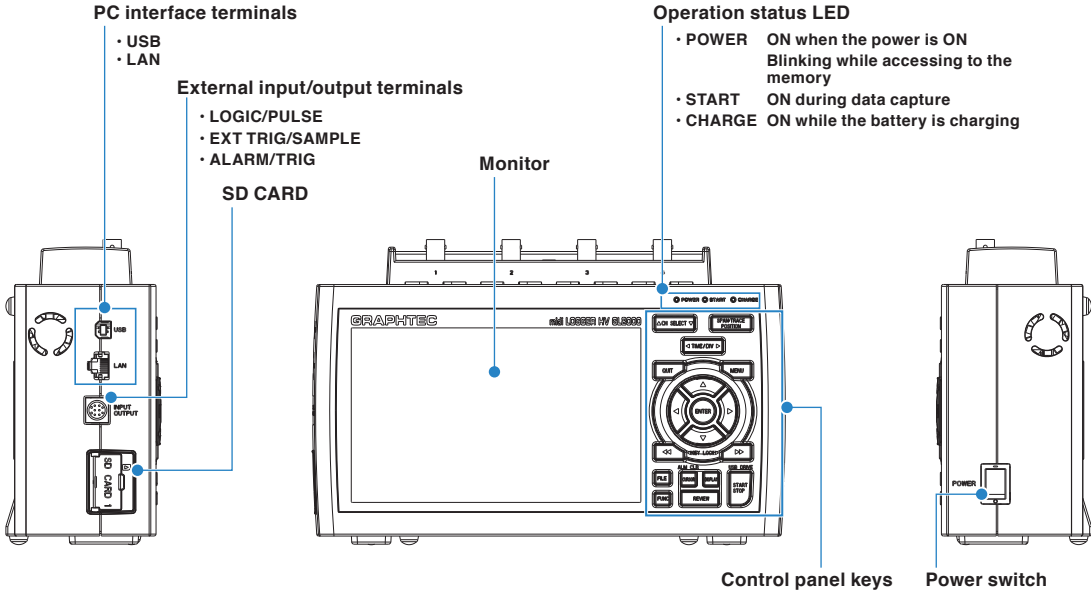

2.4 How to attach the tilt stand

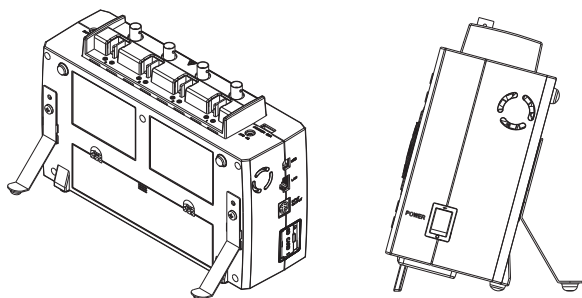

When tilt foot is used

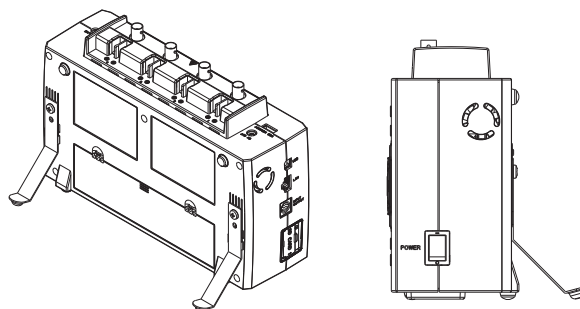

When tilt foot is not used

(1) Please pay attention to the mounting position and install the tilt foot.

● Without Rubber Protector

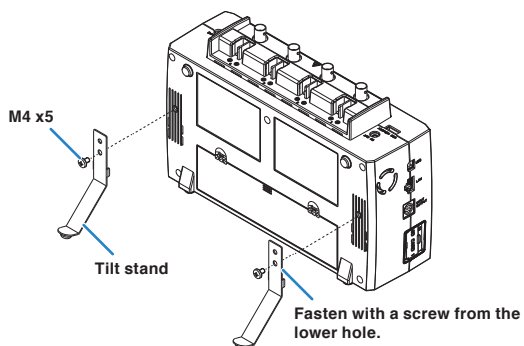

When tilt foot is used

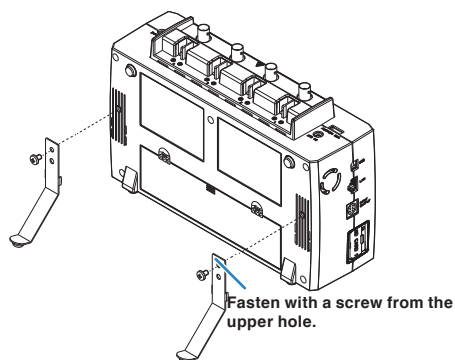

When tilt foot is not used

● With Rubber Protector

Use M4x8 screw and spacer supplied with this device.

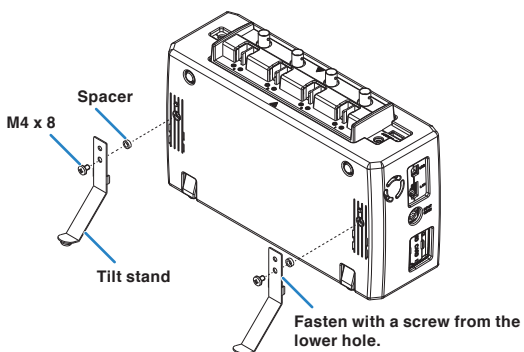

When tilt foot is used

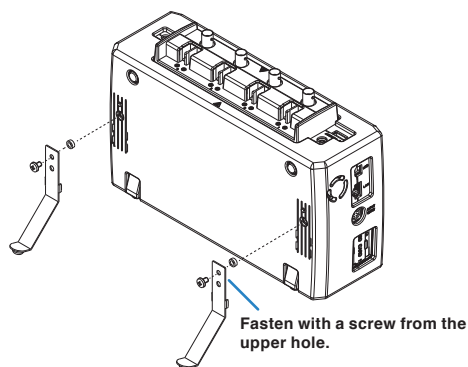

When tilt foot is not used

CAUTION

- To prevent possible malfunction, do not block the air vents of this device.
- If you use this device in other position than described in the above, the measurement accuracy may not meet the specifications.
- To prevent possible falling, attach both tilt stand and tilt foot for this device.

2.5 How to detach the rubber protector

How to attach the rubber protector

CAUTION

To remove the battery pack, first remove rubber protector.

- (1) Insert one side of this device about half into the Rubber Protector.

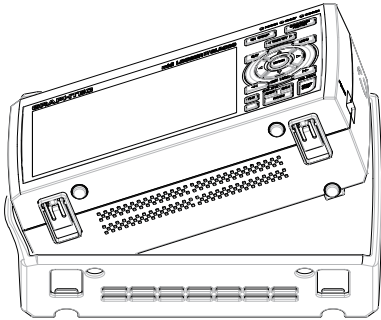

- (2) Pull the cover over the terminal block and insert the remaining half.

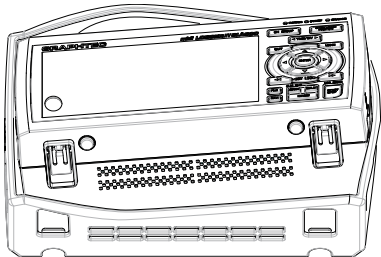

- (3) Adjust so that the rubber protector is not out of position.

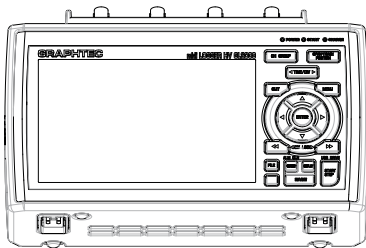

- (4) Make sure that the corners and convexities are properly fitted and adjust the protector so that there is no gap.

How to remove the rubber protector

- (1) Open the upper and lower corner of the Rubber Protector on one side of this device as shown below.
- (2) Push out the body from the back side.

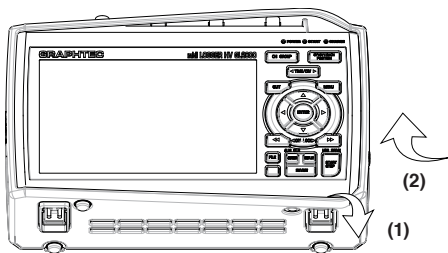

- (3) When both corners of this device are removed from the Rubber Protector, pull the protector over the terminal block.

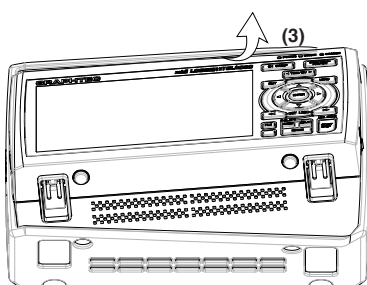

- (4) Remove the body completely from the Rubber Protector.

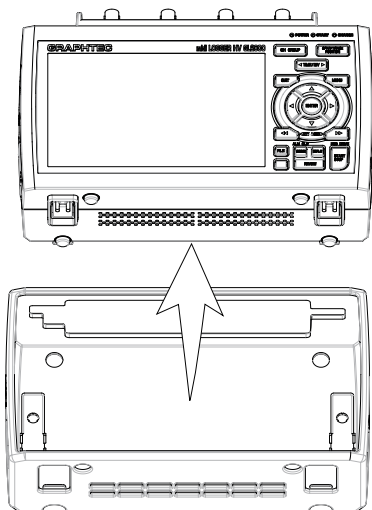

2.6 Connecting the Power Cable and Turning the Power on

This section describes how to connect the power cable and turn the power on. The connection method will vary depending on the type of power supply used.

Connecting to an AC Power Supply

Use the AC cable and AC adapter that are provided as accessories.

CAUTION

Be sure to use the AC adapter that is supplied as a standard accessory.

- (1) Plug the AC cable into the AC adapter.

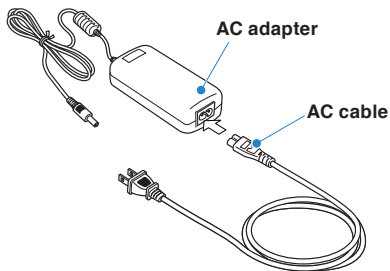

- (2) Connect the output side of the AC adapter to the connector on this device.

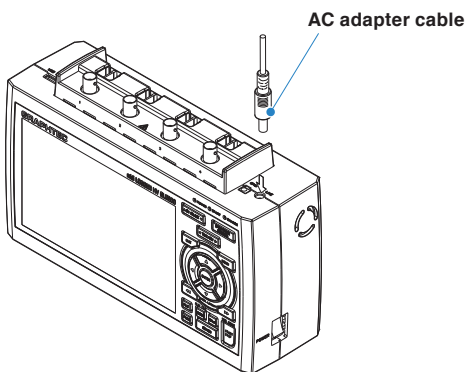

- (3) Using the flat-blade screwdriver, press against the minus (-) button above the GND terminal, while connecting the grounding cable to this device connect the other end of the cable to ground.

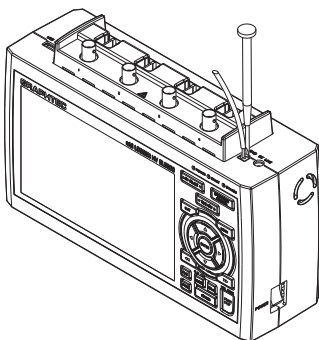

- (4) Plug the AC cable into the main power outlet.
- (5) Press the power switch to the ON position to start.

CAUTION

Always connect the GND terminal and refer to the TO ENSURE SAFE AND CORRECT USE precautions.
This device must be grounded even when connected to other devices and sharing a common ground level.

Connecting to a DC Power Supply

Use the DC drive cable (B-514: option).

⚠ CAUTION

- Use a power supply within 8.5 to 26.4 VDC range.
 - For DC drive cable, please be sure to use B-514 power cable.
-

- (1) Configure the tip of the DC drive cable (B-514: 2m) to connect to the DC power supply.
- (2) Connect the DC output side to the power supply connector on this device.

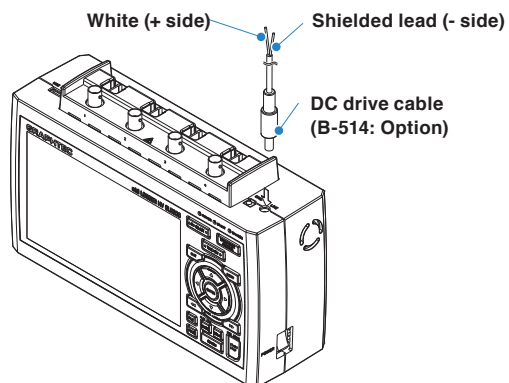

- (3) Connect the DC input side to the DC power supply.

⚠ CAUTION

Be sure to check the polarity of the wire tips when performing wiring.

- (4) Press the power switch to the ON position to start.

2.7 Connecting the Input Signal Cables

This section describes how to connect the input signal cables.

WARNING

When wiring, turn off the signal supply source to prevent electric shock. Also, position the input cables away from any power lines and ground cables.

Terminal Configuration and Signal Types

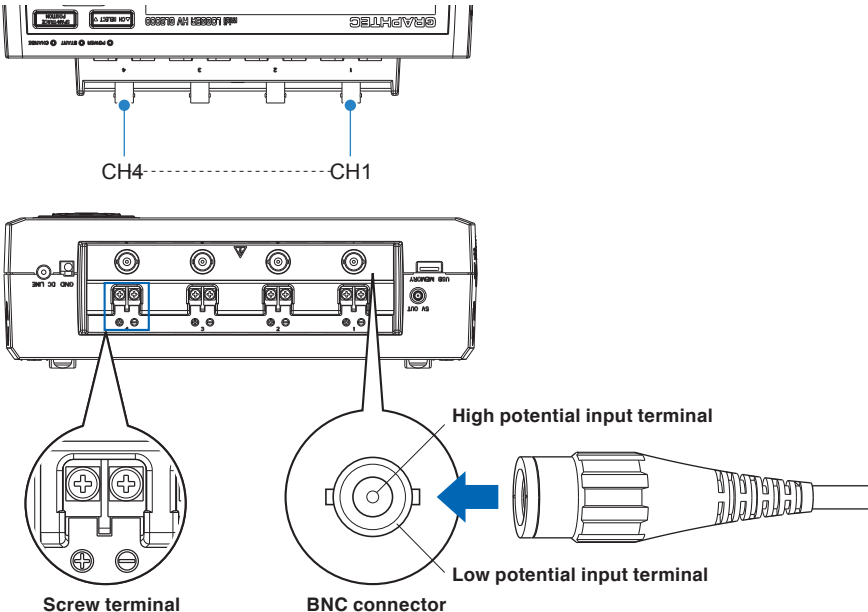

The screw terminal and the BNC connector are internally connected. You can measure with either input.

WARNING

When wiring, turn off the signal supply source to prevent electric shock. Also, wire as far as possible from the power line and ground cable.

The screw terminals of the same CH and the BNC connector are connected.

Do not input signals to the screw terminal and BNC connector of the same CH at the same time.

If a signal is input at the same time, the measurement target device may become damaged.

When wiring, turn off the signal supply source to prevent electric shock. When applying a voltage of 60V or more, please use an insulated BNC cable (RIC-142/143/147: Option) sold separately to prevent any electric shock.

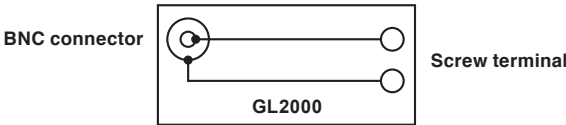

Connection diagram

DC voltage input

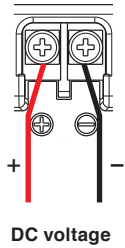

DC voltage

Thermocouple input

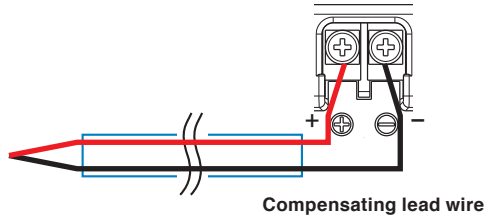

Compensating lead wire

Current input

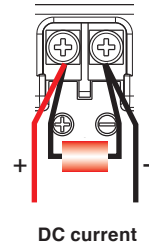

DC current

Ex: The current is converted to the voltage using the shunt register.
For 4 to 20mA current input, install 250 ohms (0.1%) resistor for converting 1 to 5V.

CAUTION

Please wire so that the main unit is not tugged by the signal input cable.
If the main unit is pulled, there is a danger where the device will tip over.

- +High potential terminal (The high potential side of the input signal is input.)
-Low potential terminal (The low potential side of the input signal is input.)

Item	Description
Input configuration	Isolated input
Measurement range	20, 50, 100, 200, 500 mV/F.S.; 1, 2, 5, 10, 20, 50, 100, 200, 500, 1000V/F.S. 1-5V/F.S
Thermocouples	K, J, E, T, R, S, B, N, W (WRe 5-26)
A/D resolution	16-bit (Effective resolution: Approx. 1/40,000 of \pm range)
Filter	Off, Line, 5, 50, 500, 5k, 50 kHz

Input cable

This device conforms to the EMC directive when the core is attached to the input cable.
Please attach the supplied core to the input cable as shown in the figure below.

* Even without a core, measurement accuracy is not affected.

When installing more than one (3 to 4 pcs.) at the same time

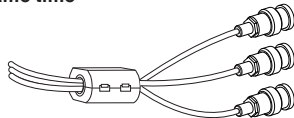

When installing to 1 or 2

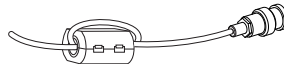

In case of thermocouple



Screw terminal

Recommended tightening torque of screw terminal is max. 6kgf/cm.

If the thermocouple tends to come off due to the use of a thin-type thermocouple, replace it with the supplied M3.5 flat screw.

2.8 Logic Alarm Cable Connection and Functions

This section describes how to connect the logic alarm cables and the functions of cable.

WARNING

When wiring, turn off the signal supply source to prevent electric shock.
Also, position this input cables away from any power lines and ground cables.

The Input/output cable for GL (B-513: Option) allows logic/pulse input, external trigger input, and alarm/trigger signal output.

Connect the Input/output cable for GL (B-513: Option) to the external input/output terminal as shown below.

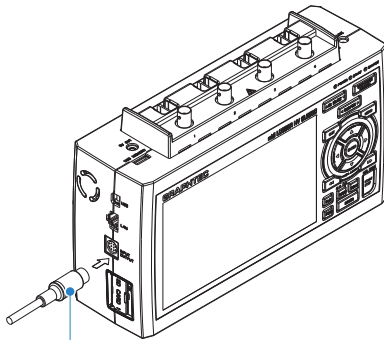

Input/output cable for GL
(B-513: Option)

Logic/Pulse Input Specifications

Item	Description
Number of input channels	4
Input voltage range	0 to +30 V max. (single-ended ground input)
Threshold level	Approx. +2.5 V
Hysteresis	Approx. 0.5 V (+2.5 to +3 V)

* Switch between logic and pulse input.

Trigger Input/External Sampling Input Specifications

Item	Description
Number of input channels	1
Input voltage range	0 to +30 V max. (single-ended ground input)
Threshold level	Approx. +1.9 V
Hysteresis	Approx. 0.2 V (+1.9 to + 2.1 V)

Alarm Output Specifications

Item	Description
Number of Output channels	4 Output 1 is used for alarm output and trigger output by switching.
Output format	Open collector output +5 V, 10 kΩ pull-up resistance * For details of alarm output, refer to the next page.
Trigger output time	When a start trigger or a stop trigger is detected, a pulse of approx.500 μs width is output from the output 1 terminal. (When setting low active and trigger output) * When a stop trigger is issued within 1 ms from the start trigger, the trigger is output at an interval of approx.1 ms.

 CAUTION

When the power is turned OFF or ON, the device temporarily becomes at an alarm state.

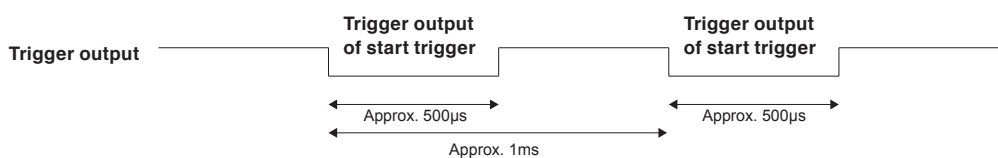

Internal equivalent circuit of I/O circuit

● Alarm output

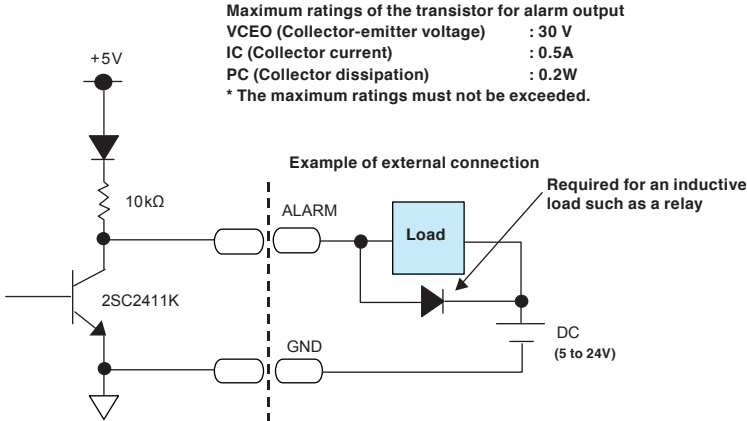

● Logic/pulse input

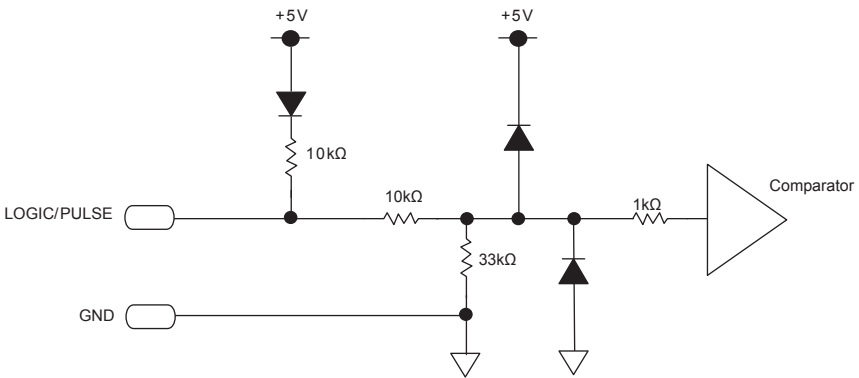

● Trigger input/external sampling input

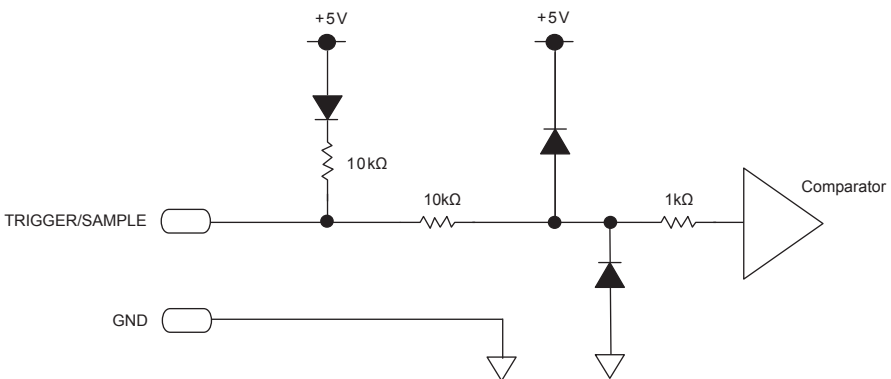

Wiring

Cable tips are bare tips. Perform wiring for the necessary functions.

Signal Name	Channel Number	Wire Color
Logic/Pulse input	1	Orange with red dotted line
	2	Orange with black dotted line
	3	Grey with red dotted line
	4	Grey with black dotted line
Output1 : Alarm output1 / Trigger output *		White with red dotted line
Output2 : Alarm output2		White with black dotted line
Output3 : Alarm output3		Yellow with red dotted line
Output4 : Alarm output4		Yellow with black dotted
Trigger input/External sampling input		Pink with red dotted line
GND		Pink with black dotted line
		Shielded

* Switch between logic and pulse.

* Output 1 is used for alarm output and trigger output by switching.

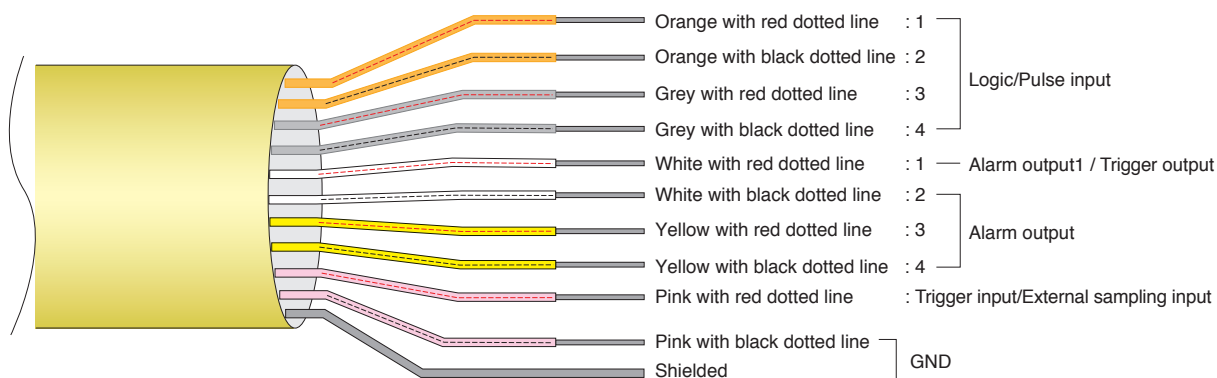

2.9 Mounting the SD Card

CAUTION

- When a SD card is inserted, make sure that the card is not locked. If locked, data will not be recorded.
- Please do not remove the SD card while accessing the SD card (Device Access display is displayed in "red" and POWER LED blinks.). The captured data may get damaged.
- When inserting a large capacity SD card, it may take some time to recognize the device.

How to insert the SD card (SD CARD)

Insert the SD card into the SD CARD slot.

- (1) Open the SD CARD cover.

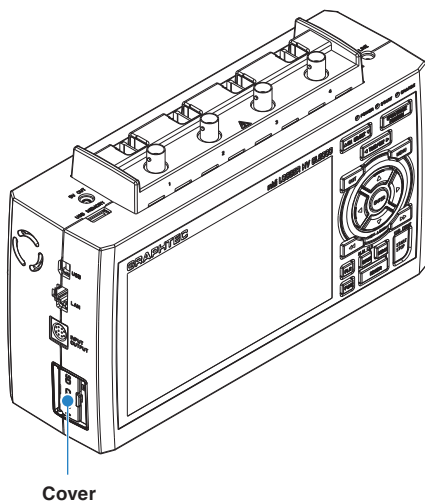

- (2) Insert the SD card until it clicks in place.

* Make sure that the SD card is not locked.

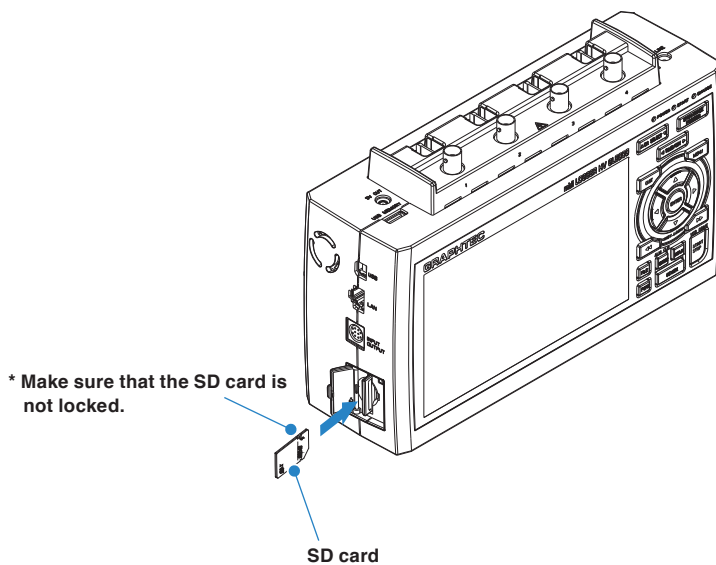

- (3) Close the SD CARD cover.

How to remove the SD card (SD CARD)

(1) Remove SD card after the device access display (SD card) on the device's screen turns green.



(2) Open the SD CARD cover.

(3) The SD card is released by pushing gently on the card. Then, remove the SD card.

CAUTION

While accessing the SD card, the device access indicator (SD card) turns red (and the POWER LED blinks).
Be sure to remove only when the indicator is green.

2.10 Installing USB Memory

⚠ CAUTION

- When handling USB memory, please pay attention to static electricity.
- Do not remove the USB memory while it is being accessed (Device access indicator turns red and POWER LED blinks). The captured data may get damaged.
- When using HDD and USB memory (4GB or more), please format them using FAT32.

How to install USB memory

Install the USB memory in the USB memory slot.

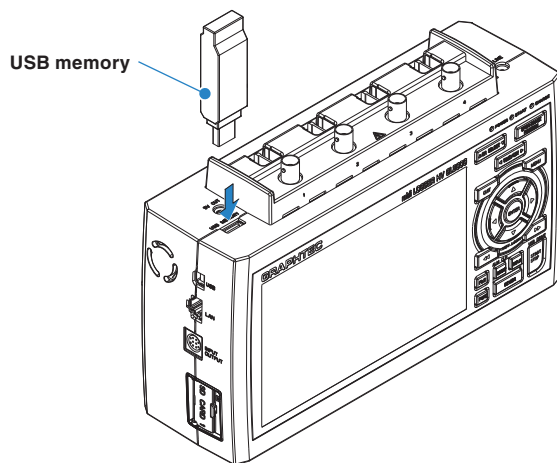

⚠ CAUTION

When the USB memory is installed in this device, please handle with care.

<USB memory specifications>

- Power supply: +5V
- Consumption current: 250 mA or less
- Capacity: Up to 32GByte memory can be used (however, up to 4GByte for 1 file)
- * USB memory with security function such as fingerprint authentication or USB memory without shell (metal part) on the connector part cannot be used.
- * USB bus power type HDD cannot be used. Format the HDD to FAT32/FAT16.

For the latest information and support information, please check the following URL.

<http://www.graph-tec.com/>

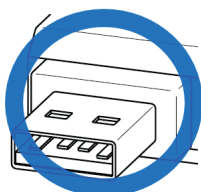

OK

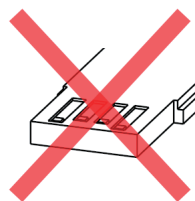

NG

2.11 Connecting to a PC

Use the USB or LAN Interface to connect this device to a PC.

Connection Using a USB Cable

- (1) This device complies with the EMC Directive in the state when the supplied ferrite core is attached to the USB cable.

To connect to the PC with the USB cable, attach the supplied ferrite core to the USB cable as shown in the following figure.

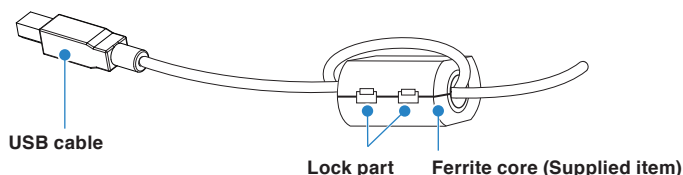

- (2) Connect between the device and PC with the USB cable.

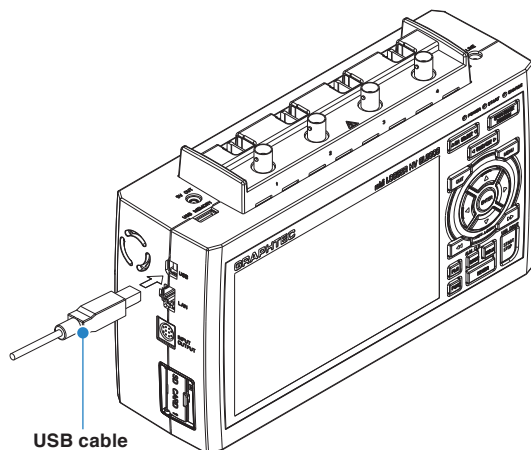

CAUTION

The USB connector is adjacent to the LAN connector. Make sure the cable is inserted into the correct insert slot.

CHECKPOINT

If the USB cable is used, the USB driver must be installed in your PC. Please refer to “USB Driver Installation Manual” in the supplied CD-ROM for the appropriate installation procedure.

- Use the cable with A and B connectors to connect this device to a PC.

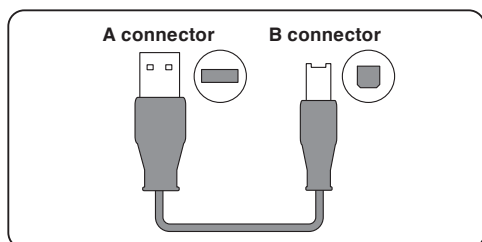

LAN Connection

- (1) This device conforms to the EMC directive when the core is attached to the LAN cable.
 - When connecting to a PC with a LAN cable, please attach the supplied core to the LAN cable.
 - For the attaching method of the core, refer to the explanation of connection using USB.
 - Please use the LAN cable of 30 m or less.
 - Use the LAN Interface to connect this device to a PC.

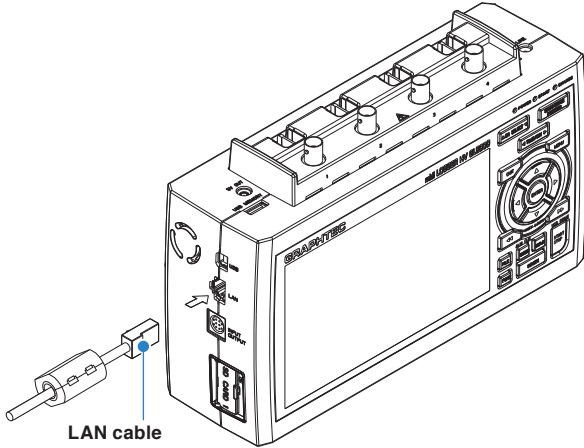

Cable Types

- Use a Cross cable to connect directly to a PC without using a hub.

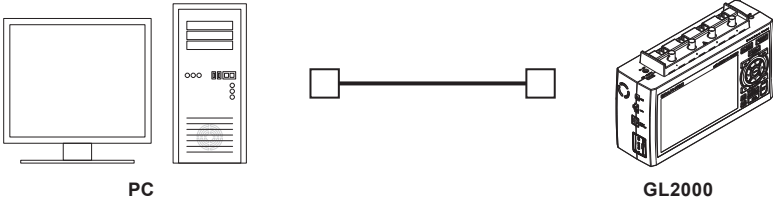

- Use a straight cable when using a hub.

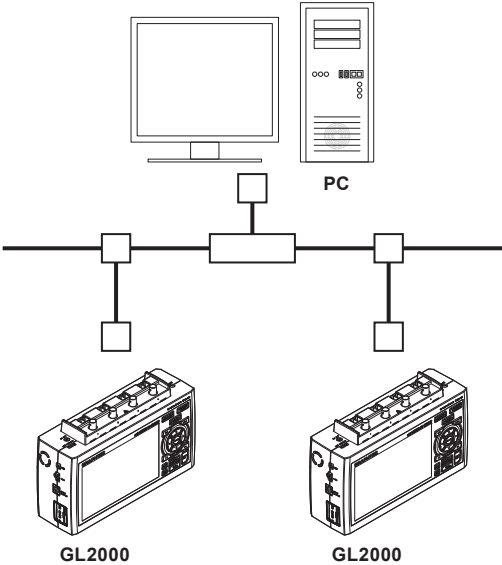

2.12 Using the Battery Pack (B-569 : Option)

- The B-569 (optional) is the only battery that can be used with this device.
- For the driving time with the battery, refer to "4.3 Accessories/Optional Accessories"
- The operating temperature ranges of this device with a battery pack mounted are as follows:
 - Running on battery : 0 to 40°C
 - Battery being charged : 15 to 35°C (at power OFF) / 15 to 25°C (at power ON)

CHECKPOINT

When the rubber protector is attached, remove the rubber protector first.

Mounting the Battery Pack

- (1) Unlock the battery cover and remove the cover.

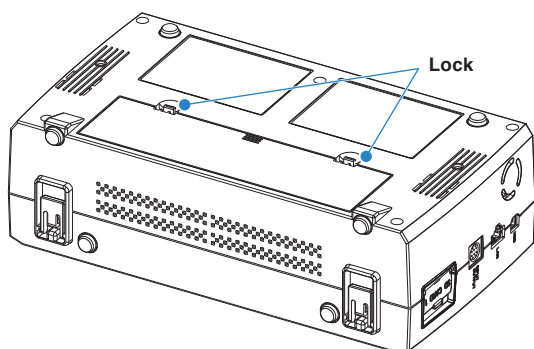

- (2) Insert the battery pack (B-569).

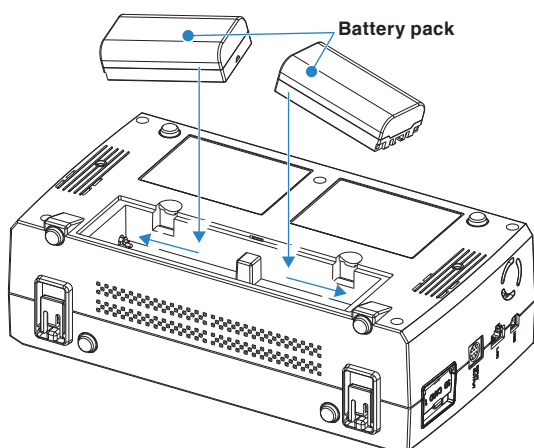

CAUTION

- Always use two battery packs.
- Do not use a new battery with an old battery at the same time.
- If you are not sure about the amount of charge each battery has, use fully-charged battery packs (x 2).

(3) Attach the battery cover.

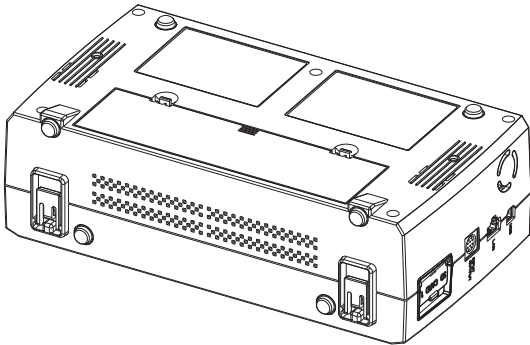

Charging the Battery

Expected time required for charging:

- Battery pack x 1: approx. 5 hours
- Battery pack x 2: approx. 10 hours

The battery pack is charged by inserting it in this device, attaching AC adapter to the device.

- (1) Insert the battery pack in the device (Refer to "Inserting the Battery Pack" in the previous page for the procedure.).
- (2) Connect the device by AC power supply. (Refer to "2.4 Connecting the Power Cable and Turning on the Power").
- (3) The CHARGE LED will illuminate while charging.

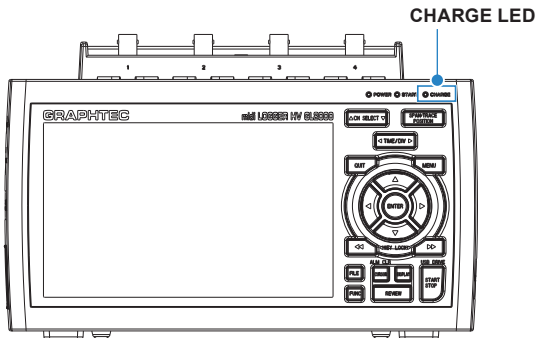

CHECKPOINT

- This device is equipped with a temperature monitor function which automatically starts charging as soon as it is cooled. Depending on the internal temperature, charging may not be performed immediately.
- When the power is on, the temperature range of the charging environment is around 15 to 25°C.(When power is off, it is about 15 to 35°C.)
- When charging is attempted while the power is ON, charging may not initiate immediately even if the temperature environment conforms to the specification. In that case, set the Screen Saver settings to ON or start charging while the power is turned off.

 **CAUTION**

- During data capture, when the battery power is at low, the capturing stops automatically.
 - When using in conjunction with AC adapter, this device automatically shifts to battery-powered at the time of power outage.
At such time, pay attention to the remaining battery power. If the low-charged battery is inserted, this device may stop abnormally due to power failure or instantaneous interruption.
 - While power is supplied directly from the DC power without the AC adapter link, and the DC voltage reaches 16V or less, the battery charge disables.
 - When an empty battery is charged in other recorder GL220/820/900 units, the charging will stop at about 80-90%. Disconnect and re-connect the AC adapter, or remove and insert the battery pack to start charging the battery to reach up to 100%. (depending on the remaining capacity.)
-

2.13 Connecting the Humidity Sensor

Connect the + and - lead wires of the humidity sensor (the B-530: Option) to the selected terminals, then insert the round connector into the 5V OUT connector on this device.

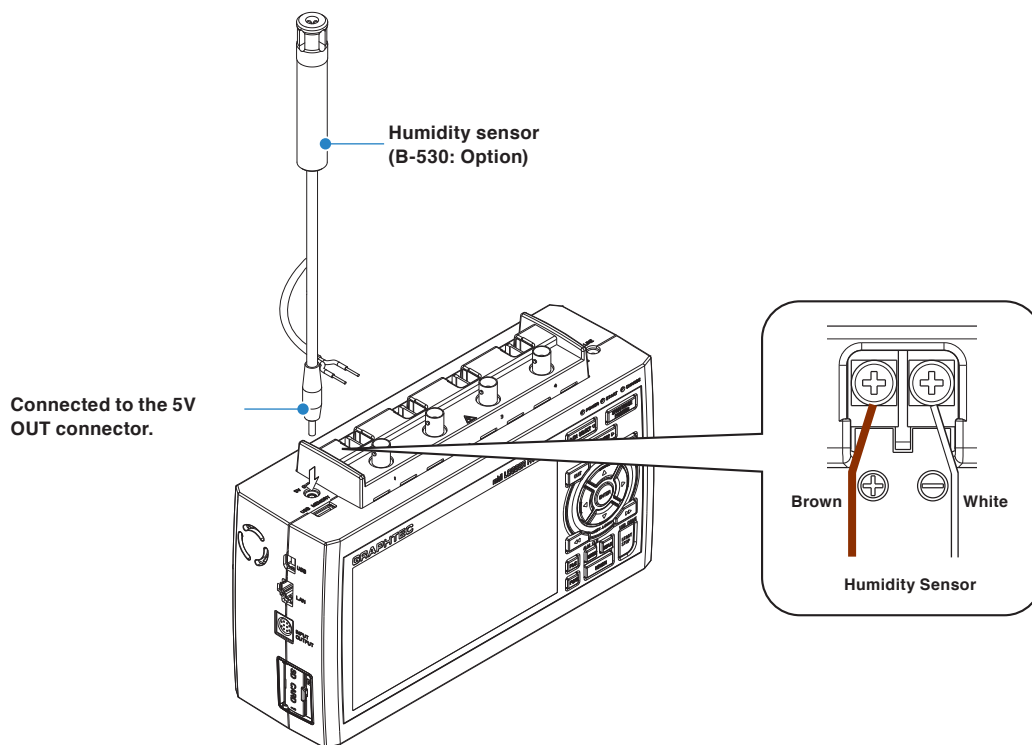

CAUTION

- Do not use the sensor in a strong electric field environment. Measured results may not satisfy as stated.
- 5V OUT connector on this device is available for only one humidity sensor.

2.14 Precautions to Observe When Taking Measurement

To avoid break-downs or short-circuiting accidents, please make sure to follow warnings written below.

WARNING

- Use only the AC adapter provided as a standard accessory. The rated power supply range for the adapter is 100 to 240 VAC, and the rated frequency is 50/60 Hz. Do not use any other voltages.
- Do not input the voltage that exceeds the specification of this device.
 - If a voltage exceeding the specified value is input, the semiconductor relay in the input section will be damaged. Never input a voltage exceeding the specified value even for a moment. It will cause fire.
 - Have enough margin from the specification of withstanding voltage when using this device, it has to consider a noise and change of the measurement voltage.
 - Confirm this device is not broken before the input cable is connected to the input terminal.
 - Please take care of the static electricity when connecting the input cables or the thermocouples.
 - Do not touch the tip of thermocouples with bare hand after the thermocouples are connected to the terminal of this device when the tip is not insulated.
The static electricity from a human body will cause damage to the device.
 - Do not put the tip of thermocouples to an object which contains static electricity when the tip is not insulated. The static electricity from object will cause damage to the device.
 - Do not put the tip of thermocouples to the object which contains leaked high voltage from chassis or metal etc. when the tip is not insulated.
The leaked high voltage from object will cause damage to this device.
 - We recommend that an insulation tape is placed on the tip of thermocouples before connecting it to the input terminals.
This will protect the device from the static electricity and the leaked high voltage.
- To prevent electric shock and short circuit accident, do not connect to BNC terminal and screw terminal at the same time.

When using

Please be sure to read the following carefully in order to prevent electric shocks or short circuit.

● Maximum input voltage

If a voltage exceeding the specified value is input, the parts in the input area will be damaged. Never input a voltage exceeding the specified value even for a moment.

< Between +/- terminals (A) >

- Maximum input voltage : Range of 20mV to 2V : AC/DC 30V
Range of 5V to 1000V : AC/DC 600V

<Between input terminal and input terminal (B) >

- Maximum input voltage : AC/DC 600V(CATIII)/ AC/DC 300V (CAT IV)
- Withstand voltage : AC/DC 5400V at 1 minute

<Between input terminal and GND (C) >

- Maximum input voltage : AC/DC 600V(CATIII)/ AC/DC 300V (CAT IV)
- Expected transient overvoltage : AC/DC 5400V at 1 minute

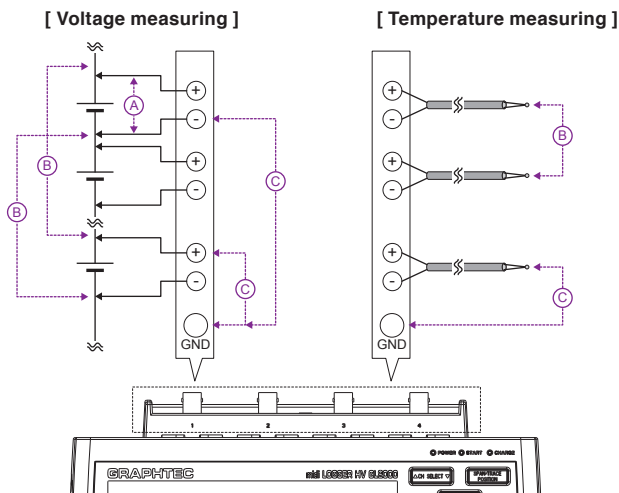

2.15 Noise Countermeasures

- **Connect the chassis GND of the measurement object.**

Ensure that a chassis GND wire of the measurement object is connected to a good ground.

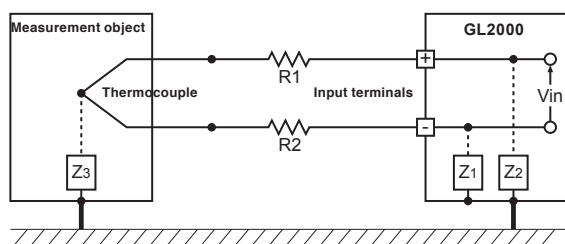

- **Connect the signal chassis GND to the measurement device chassis ground.**

Use a short, thick lead to connect the chassis GND of the measurement object to this device's chassis GND. It will become even more effective if the ground potentials are the same.

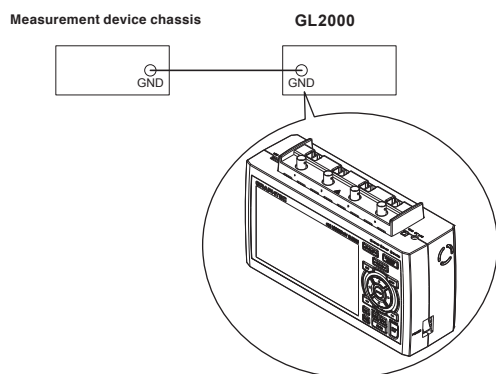

- **Noise countermeasures**

If measured values fluctuate due to extraneous noise, conduct the following countermeasures.

(Results may differ according to noise type.)

Ex 1 : Connect this device's GND to ground.

Ex 2 : Connect this device's GND to measurement object's GND.

Ex 3 : In the AMP settings menu, set filter to any setting other than "OFF".

2.16 When Fixing This Device

When fixing this device to prevent the dropout, use the two nuts on the back panel.

* Recommended tightening torque: 14kgf/cm

When fixing this device, please use it in a vertically placed state.

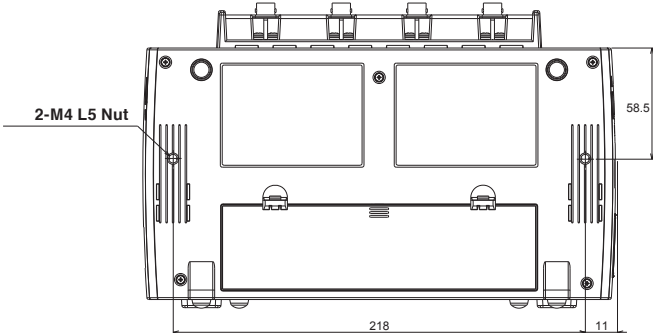

CAUTION

To prevent possible malfunction, do not block the air vents of this device.

If the device is installed in states other than the described state above, the measurement accuracy may not meet the specifications.

2.17 Setting the Date and Time

If you are using this device for the first time, first charge the internal rechargeable battery and then make the date and time settings.

CAUTION

If this device is not used for a period of approximately six months or longer, the internal rechargeable battery may be discharged and the date and time may revert to the initial settings. If this happens, recharge the battery and reset the date and time before using this device.

How to Recharge the Rechargeable Battery

Using the AC adapter provided, connect the device to a mains power source, turn on the power switch, and then allow the device to charge for at least 24 hours.

How to Set the Date and Time

Press the [MENU] key, display the “OTHER” screen, and then set the date and time at the Date/Time Settings sub-menu. For details, refer to “3.4 Setting Menus” - “Date/Time”.



CHAPTER 3 Settings and Measurement

This chapter describes the setting and measurement procedures for this device.

PRODUCT SUMMARY

- 3.1 Window names and functions***
- 3.2 Key Operation***
- 3.3 Description of the display mode***
- 3.4 Operation Modes***
- 3.5 Setting Menus***
- 3.6 WEB Server Function***
- 3.7 List of Error Codes***

3.1 Window names and functions

Y-T Screen

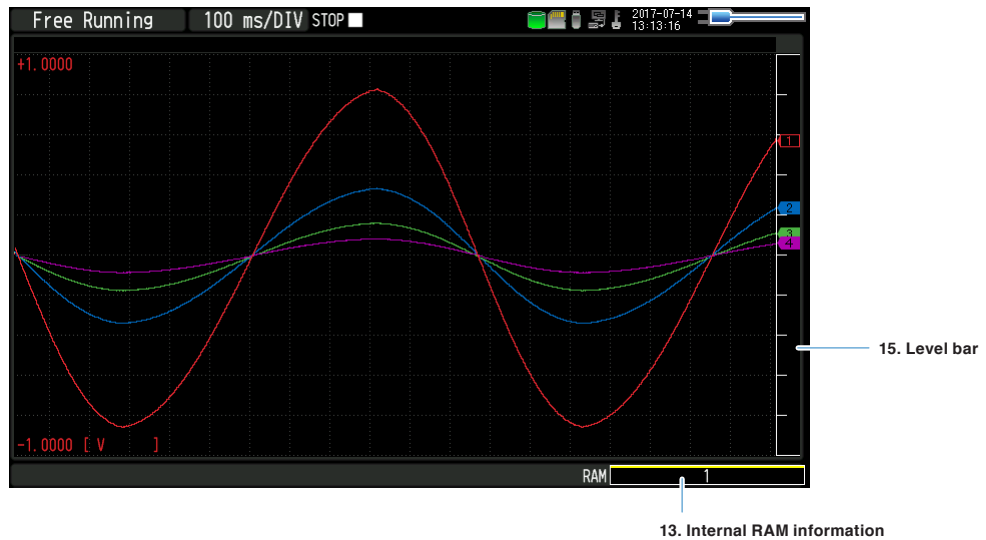
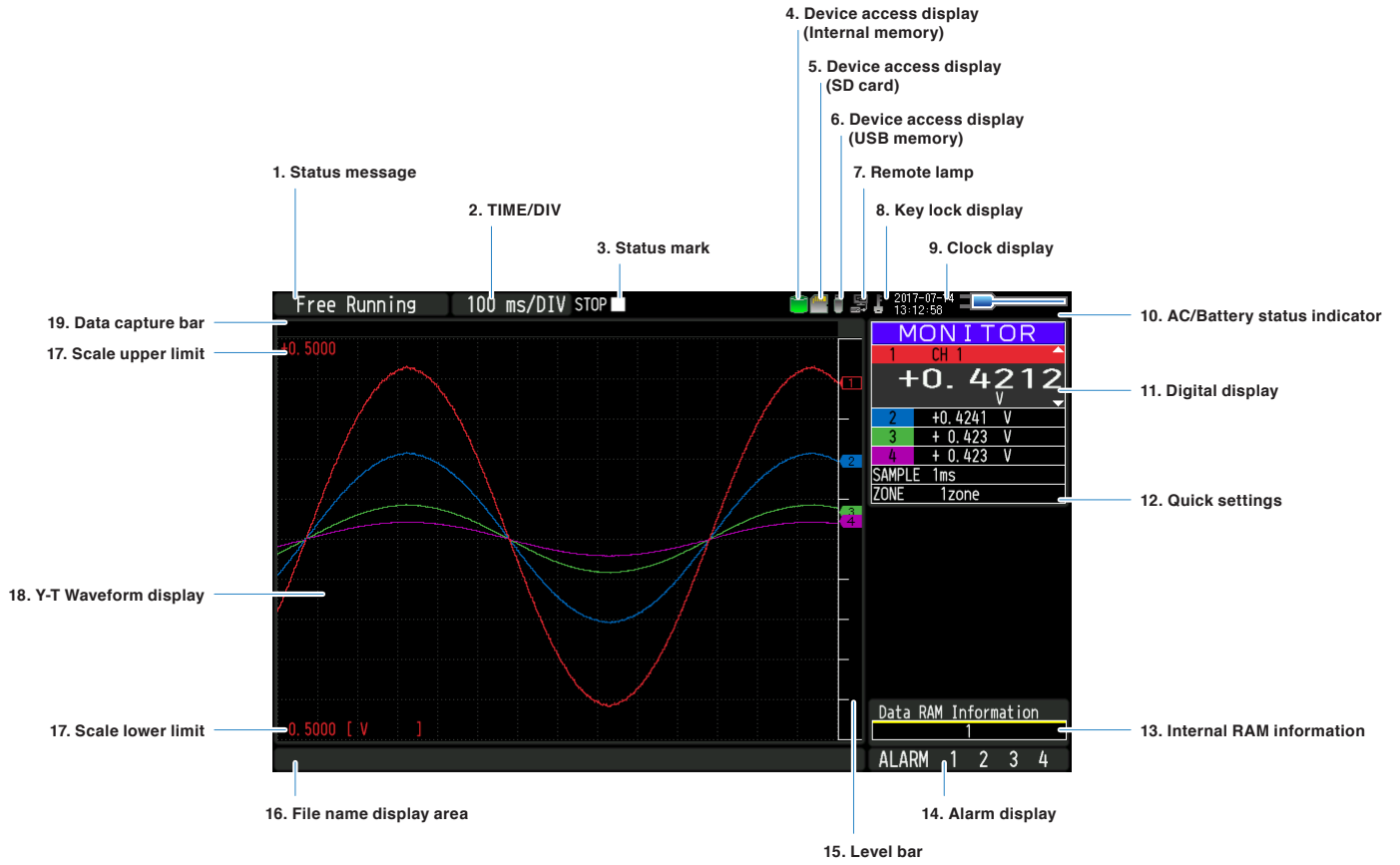

Logging screen

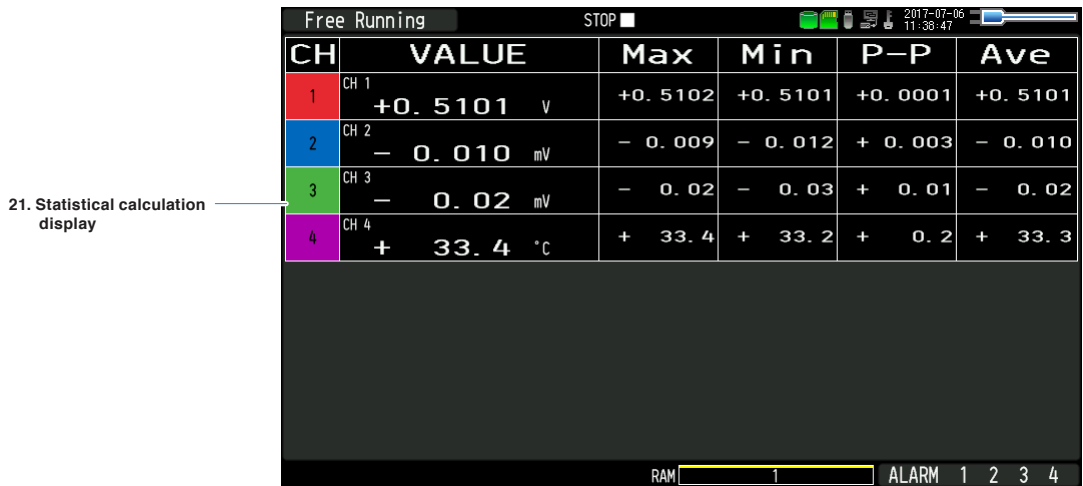
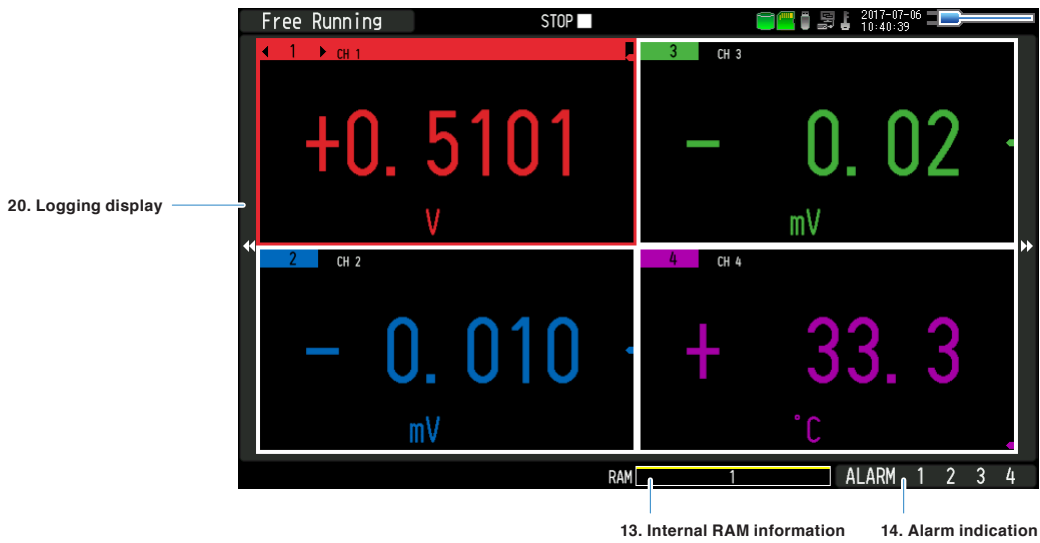

XY Screen

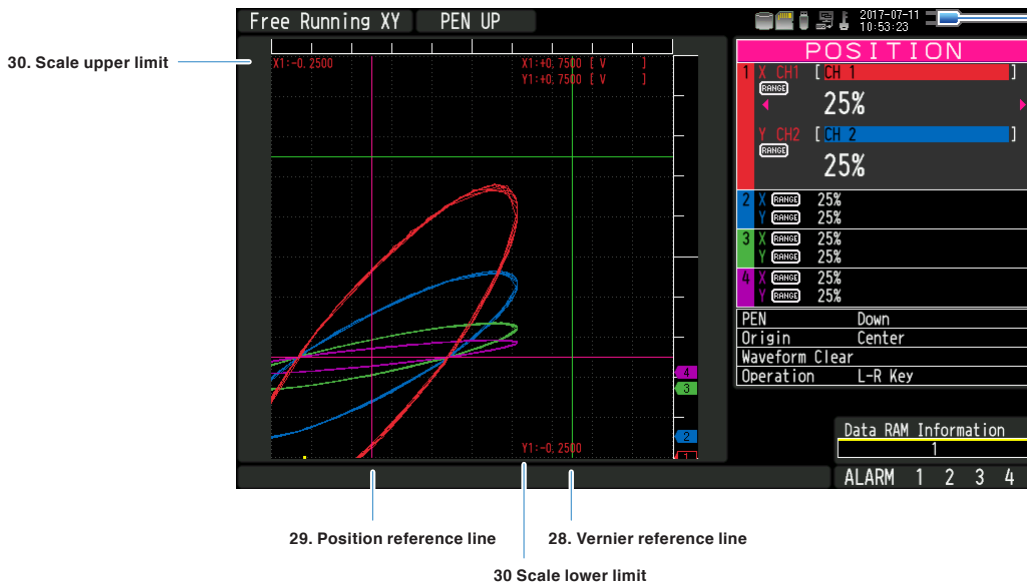
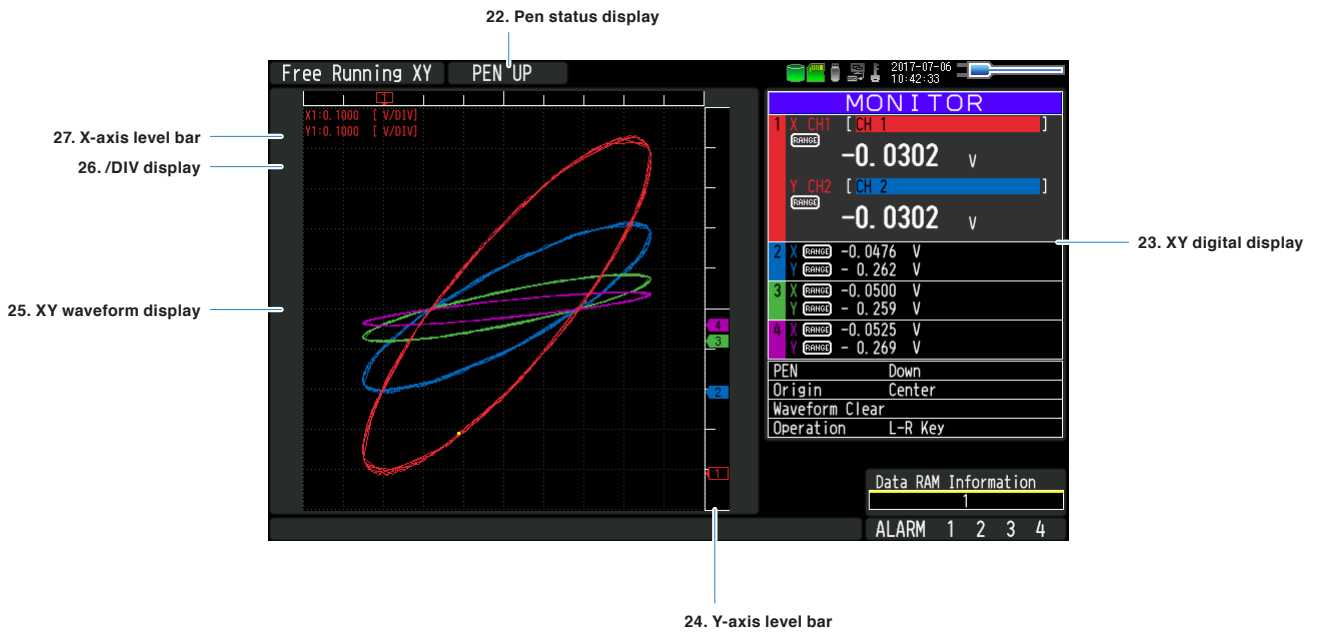

1. Status message

Displays the operation status of this device.

Free Running	: Displayed when data is not being captured.
Free Running XY	: Displayed when data is not being captured while XY Screen is used.
Recording pretrigger	: Displayed when the pre-trigger capturing is in progress with the setting to wait for pre-trigger to complete.
Armed	: Displayed while waiting for trigger to initiate after recording has started.
Rec to Int RAM	: Displayed when data is captured to the internal RAM.
Rec to Int Mem *	: Displayed when data is captured to the internal memory.
Rec to SD card *	: Displayed when data is captured to the SD card.
Rec to USB Mem *	: Displayed when data is captured to the USB memory card.
Recording	: Data capturing operation is performed by our application software when connect to the PC. This status message is displayed when data is not captured to the device.
Finished	: Displayed when the device waits for you to press the [START/STOP] key to stop recording after data capture.
Repeat Waiting	: Displayed when waiting for the repeat interval.
Int RAM Replaying	: Displayed when data in the internal RAM is replayed.
Int Mem Replaying *	: Displayed when data in the internal memory is replayed.
Playing SD card *	: Displayed when data in the SD card is replayed.
USB Mem Replaying *	: Displayed when data in the USB memory is replayed.
Record/Replaying *	: Displayed when replaying during data capture.
Auto Save... *	: Displayed when auto save process is in progress.
Backup failed	: Displayed when backup fails (The SD card of the backup destination is removed, etc.).
Demo Wave Mode	: Displayed when demo waveforms are being displayed.
Remote lock off	: Displayed while remote lock is released.

* For details of data capture such as trigger and repeat etc., refer to “3.5 Setting Menus” - “(4) TRIG settings”.

* For details of capture settings, refer to “3.5 Setting Menus” - “(2) DATA settings”.

* For details of remote lock release function, refer to User’s Manual GL-Connection.

CAUTION

Please do not turn off the power when the status message states “Capturing to internal memory” or “Capturing to SD card” (“*” status mark).

Start the operation after making sure that the status mark is switched to "STOP".





2. Time/DIV display

With the Y-T Screen, the current time scale is displayed.

Time scale is the current time scale per grid on the horizontal axis.

The display width of the horizontal axis (T-axis) of the waveform is adjustable by changing this value.

3. Status mark



-  : Appears when neither capture nor replay is in progress.
-  : Displayed when the captured data is being recorded.
-  : Appears when waiting for a trigger during capturing and for the stop key after capturing.
-  : Displayed when replaying the captured data.
-  : Displayed when replaying during capturing the data (Refer to in “3.2 Key Operation” - “(10) REVIEW”).

CAUTION

Please do not turn Off the power and do not remove the SD card or USB memory when the status mark indicates other than “STOP”. The data will be damaged, and it will not be accessible.

Please start the operation after making sure that the status mark is switched to "STOP".

4. Device access display (Internal memory)



-  : Internal memory is recognized but is not being accessed.
-  : Internal memory is being accessed. While the internal memory is being accessed, the POWER LED also flashes.

CAUTION

Please do not turn Off this device’s power when accessing the internal memory.

Data will be damaged, and it will not be accessible.

5. Device access display (SD card)

-  : SD card is not attached.
-  : SD card is attached but not accessible.
-  : SD card is being accessed. Do not remove the SD card. The POWER LED light also flashes during accessing the SD card.

CAUTION

Please do not remove the SD card and do not turn off power when accessing the SD card.

Data will be damaged, and it will not be accessible.

6. Device access display (USB memory)



: USB memory is not attached.



: USB memory is attached but not being accessed.



: USB memory is accessed. Do not remove the USB memory. The POWER LED light also flashes while the USB memory is being accessed.

CAUTION

Please do not remove the USB memory and do not turn off power when accessing the USB memory. Data will be damaged, and it will not be accessible.

7. Remote lamp



: Indicates local mode. Operations can be conducted on the device.



: Indicates remote mode. With some exceptions, operations must be conducted on a PC.

When you cancel the connection on the application software, the device automatically returns to local mode. If local mode is not entered, press the [QUIT] key.

8. Key lock display



: Not in key lock status. Normal operations are permitted.



: Key lock status. All keys are locked.







Refer to “(15) Key lock release with password” in “3.2 Key Operation” for details on the key lock.

9. Clock display

Displays the current date and time.

For details on date and time settings, refer to “3.5 Setting Menus” - “(6) OTHER settings”.

10. AC/battery status indicator

	: Running on AC or DC power supply.
	: Running on battery. The remaining battery power is 100 to 91%.
	: Running on battery. The remaining battery power is 90 to 61%.
	: Running on battery. The remaining battery power is 60 to 31%.
	: Running on battery. The remaining battery power is 30 to 11%.
	: Running on battery. The remaining battery power is 10% or below.

CAUTION





- Data capture automatically stops when the remaining battery power drops to 10% or below during. Auto Save will be performed even when Auto Save is not set while data is being captured to the internal RAM.
- The power is automatically turned off when the remaining battery power is 0%.
- Use the remaining battery display only as a reference.
This indicator does not guarantee the exact operating time of a battery.

11. Digital display of Y-T screen

Displays the input value of each channel and span. Use the [SPAN/TRACE/POSITION] keys to switch the display.

Use the ▲ ▼ keys to select the channel you want to activate (enlarged display).

The waveform of the active channel is displayed at the top.

	: Displays the input value.
	: The span of the active channel can be changed using the ◀▶ keys.
	: The position of the active channel can be changed using the ◀▶ keys.
	: The ON or OFF of the active channel display can be changed using the ◀▶ keys.

For details, refer to “3.2 Key Operation” - “(2) SPAN/TRACE/POSITION”.

As described below, the CH indicating the calculation mark is the channel which calculation between the CHs is enabled (On).

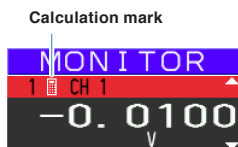

12. Quick settings









The settings of the sampling interval and the division of waveform display can be changed. Use the ◀▶ keys to activate the Quick setting and the left/right keys to change values.

* The "SAMPLE" item cannot be changed during data capture.

13. Internal RAM information

Displays the status of the internal RAM. The status of the block can be judged by the color of each block. For the number of blocks, set the division number by "memory block division".



-  : Data was not captured. It is an empty block.
-  : Pre-trigger data is being captured.
-  : Data is being captured.
-  : Data capture is completed but auto save is not performed.
-  : Data capture is completed. Auto save has been performed.
-  : Auto save is performed. The auto save progress is indicated by a dark green bar.
-  : The yellow line at the top of the block indicates that this device is capturing.
-  : The yellow line at the top of the block indicates the block scheduled to be captured next time.

14. Alarm display

Displays the alarm output status.

The number with which an alarm went off is displayed in red. The channel with the alarm threshold has a red input value in the digital display area.

15. Level bar

Displays the channel signal position, trigger position and alarm range.

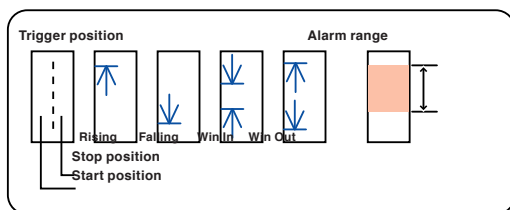

16. File name display

(1) During data capture

A file name is displayed during the recording.

```
<MEM>170711\PREFIX_170711-130955.GBD
```

* If the ring capturing setting is ON, a file name displayed during capture ends with "_RINGx" (x represents a number) but the actual file name does not include "_RINGx".

As an example, if the ring capturing is set to ON in the above figure, the file name during recording will be displayed, as "<MEM>170711\PREFIX_170711-130955_RING4.GBD" but the actually file created will be "<MEM>170711\PREFIX_170711-130955.GBD".

* For details, refer to "3.5 Setting Menus" - "(2) DATA settings".

(2) During data replay

Information on the time axis of the cursor is displayed during Y-T replay.

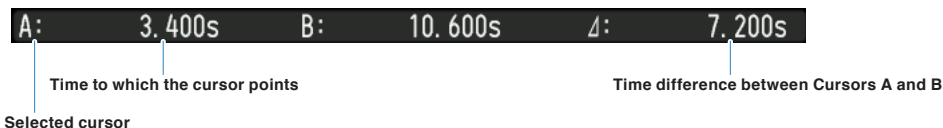

17. Scale upper/lower limit

Displays the scale upper/lower limit of the currently active CH.

18. Y-T waveform display

Displays the Y-T waveform of the input signal.

(The vertical axis is the measured value and the horizontal axis is time.)

19. Capture bar

(1) During recording

Displays the elapsed time and the usage status on the internal memory, the SD card and the USB memory usage.

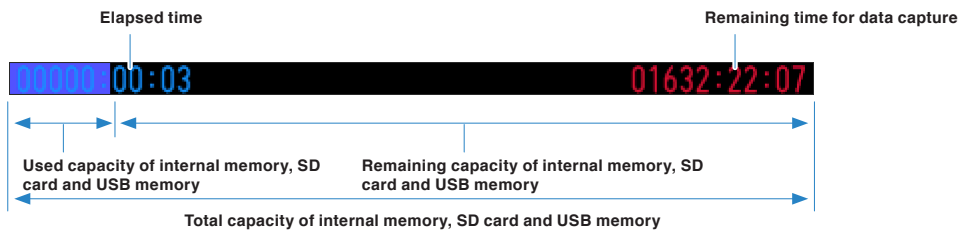

For example, when you are using a 4GB SD card with 100MB already used, the total capacity of the SD card is 4GB with 100MB used space, and the available space of the SD card would be approximately 3.9GB. As the captured time elapses, the usage of the SD card increases and the remaining capacity of the SD card decreases.

The remaining recording time indicates the remaining capacity of the SD card.

However, when the relay capturing function is set to Off, and when the remaining capacity of the SD card exceeds 4GB, the remaining time that can be captured to 1 file will indicate 4GB.

* Remaining time which is more than 99999 hours is displayed as "++++:++:++".

(2) During data replay

Show the display position, cursor position, and trigger position graphically.

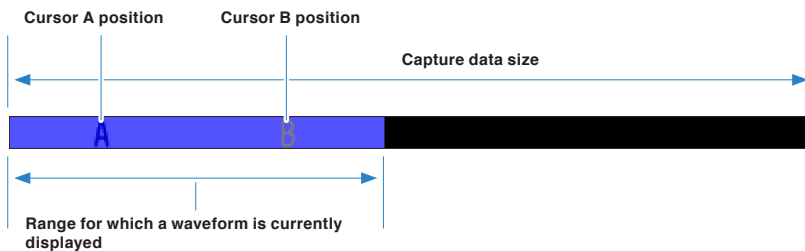

20. Logging display

Displays the digital value of the input signal in large character.

The window can be divided into 2, 4 or 8 displays. Select from choices of analog CH, logic, or pulse CH.



2-divided

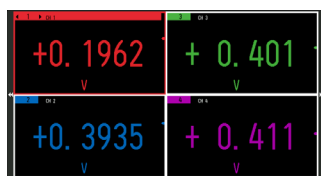

4-divided



8-divided

21. Real time statistical calculations display

Displays the real time statistical calculation result (simultaneous display for 4 different calculations).

CH	VALUE	Max	Min	P-P	Ave
1	CH 1 +0.5101 V	+0.5102	+0.5101	+0.0001	+0.5101
2	CH 2 - 0.010 mV	- 0.009	- 0.012	+ 0.003	- 0.010
3	CH 3 - 0.02 mV	- 0.02	- 0.03	+ 0.01	- 0.02
4	CH 4 + 33.4 °C	+ 33.4	+ 33.2	+ 0.2	+ 33.3

Real time value

Maximum value

Minimum value

P-P value

Average value

22. Pen status display

Displays the UP/DOWN status of the pen in the XY screen.

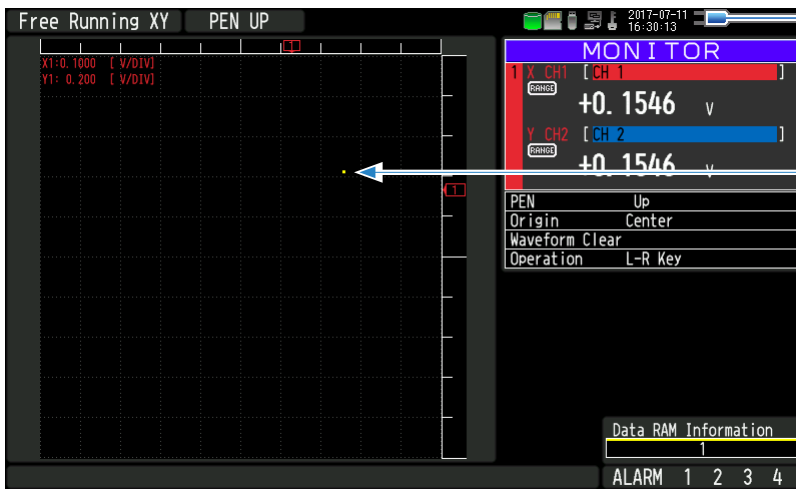

The current pen position is drawn with a yellow dot.

When pen is UP status

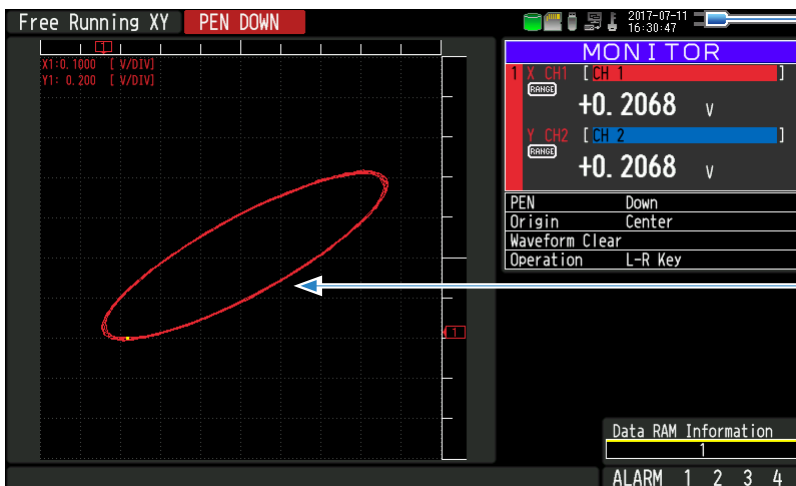

The trajectory of the pen is drawn with color used with XY-CH.

When pen is DOWN status

When recording starts, the display automatically puts the pen on DOWN status.

23. XY screen digital display

Displays the input value of CH set to XY-axis, /DIV display, Position, Vernier. To switch the screen use the [SPAN/TRACE/POSITION] key.

L-R key mode:

Select the XY-CH and the axis to be activated (enlarged display) with the ▲ ▼ keys or [CH SELECT] key. In addition, the waveform display of active XY-CH is shown at the top of the screen.

Change the settings of the selected axis of the selected active XY-CH with the ◀ ▶ keys.

Cross key mode:

Select XY-CH to be active (enlarged display) with the [CH SELECT] key. In addition, for active XY-CH, the waveform is shown at the top of the screen.

For the selected active XY-CH, change the settings of the X-axis with the ◀ ▶ keys, and the Y-axis with the ▲ ▼ keys.

- MONITOR : Displays the input value.
- RANGE/SPAN : Changes the Range/Span of active XY-CH.
- POSITION : Changes the Position of active XY-CH.
- VERNIER : Changes the Vernier of active XY-CH.

CAUTION

- The settings of Range/Span, Position and Vernier belong to each analog CH.
 - When the same analog CH is assigned to another XY-CH, changing the setting of one XY-CH changes all the XY-CH settings at the same time.
-

For details, refer to “3.2 Key Operation” - “(2) SPAN/TRACE/POSITION” and “3.3 Operation Modes” - “(3) XY waveform display” - “XY digital display”.

In XY-CH display, the contents of the X-axis (horizontal axis) are shown on the upper row and the contents of the Y-axis (vertical axis) are at the lower row.

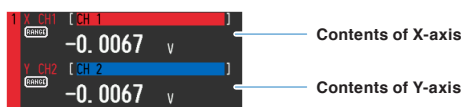

24. Y-axis level bar

Displays the signal position of CH set on the Y-axis.

In the Y-axis level bar, the trigger range and the alarm range are not visible.

25. XY waveform display

Displays XY waveform graph.

Set any analog CH to X-axis (horizontal axis) and Y-axis (vertical axis) respectively.

26. DIV display

Displays the measurement amount (unit) for one grid in XY waveform graph.

27. X-axis level bar

Displays the signal position of CH set on the X-axis.

In the X-axis level bar, trigger ranges and alarm ranges are not visible.

28. Vernier reference line

Displays the Vernier reference line when POSITION setting and the Vernier setting are visible on the XY digital screen or when "Origin" is selected by the Quick setting (a green straight line).

When the Vernier is set to 100%, Vernier reference line is visible at 5DIV position.

When the Vernier setting is changed, Vernier reference line moves according to the percentage (%) of Vernier.

For example, when the Vernier is set to 80%, the Vernier reference line moves to 4DIV position.

For details of Vernier function, refer to "3.3 Operation Modes" - "(3) XY waveform display" - "Vernier".

29. XY position reference line

Displays when the Position settings and the Vernier settings are visible in the XY digital screen or when "Origin" is selected by the Quick setting (It is a pink straight line).

In the Range mode, the reference value is 0V (0Vrms).

In the Span mode, the reference value is the center position of the span.

The XY position reference line indicates the display position of the reference value.

For the XY position, the reference position can be set to the left (lower) of the XY graph as 0% and the right (upper) as 100%. (Be cautious of the difference from the Y-T graph position setting.)

For details of the XY position function, refer to "3.3 Operation Modes" - "(3) XY waveform display" - "XY position".

30. XY upper/lower scale

Show the XY upper/lower scale when the Position setting and the Vernier setting are displayed in the XY digital screen.

The measured values of the left and right edges (X-axis) and the upper and lower edges (Y-axis) of the XY graph are displayed.

3.2 Key Operation

This section describes key operation.

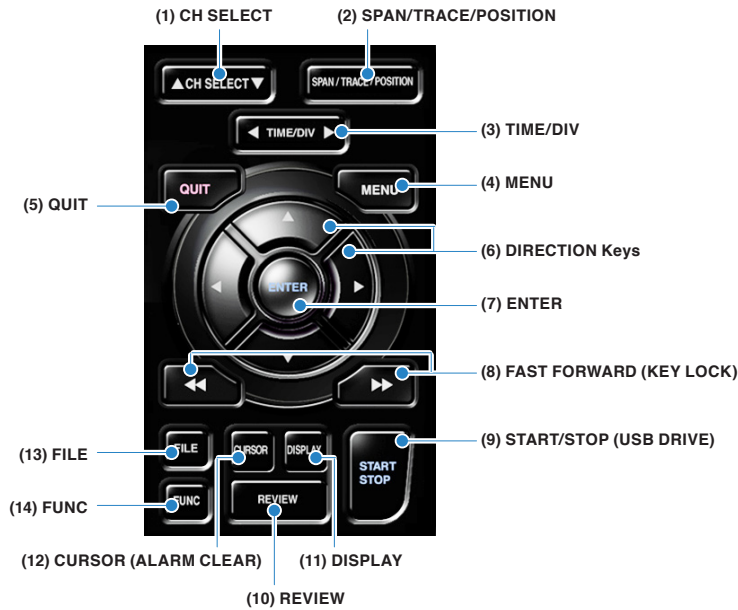

(1) CH SELECT

Moves CH and item in digital display.

Use ▲ ▼ keys on the CH SELECT buttons to move the logging screen and real time statistics calculation screen up and down.

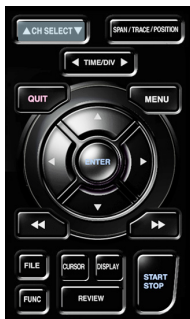

Y-T waveform screen

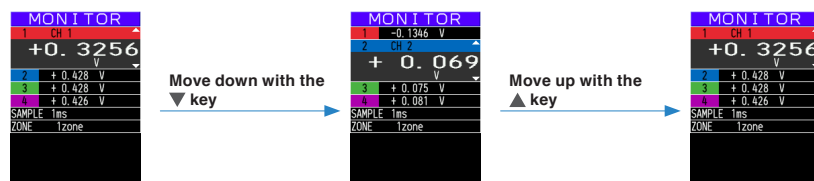

XY waveform screen

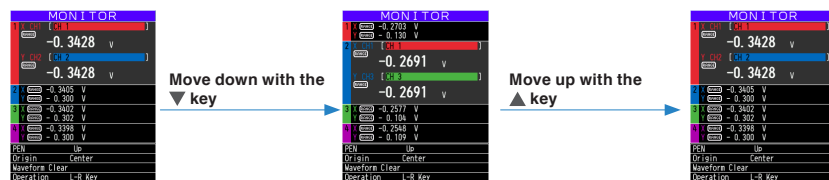

(2) SPAN/TRACE/POSITION

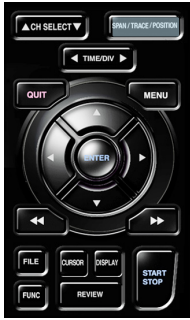

Switch to change the information on the digital display.
 Use to change the settings related to waveform display during Free Running, data capture and data replay.
 Pressing the key will switch displays as follows:

Y-T screen

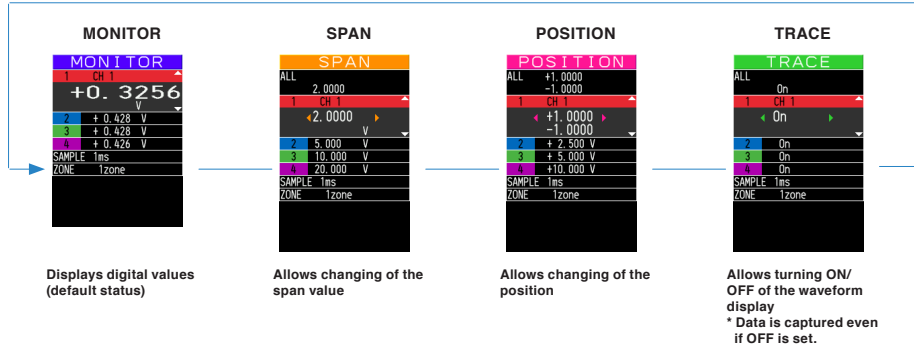

Use [CH SELECT] key or ▲ ▼ keys to move the CH.
 Change the contents of the selected CH with ◀ ▶ keys.

- * When set at ALL, setting values for CH1 is reflected on other channels. When CH1 is OFF, setting for ALL is disabled.
- * When Logic CH is selected, use ◀ ◀ ▶ ▶ keys to select individual CH for Logic.



XY screen

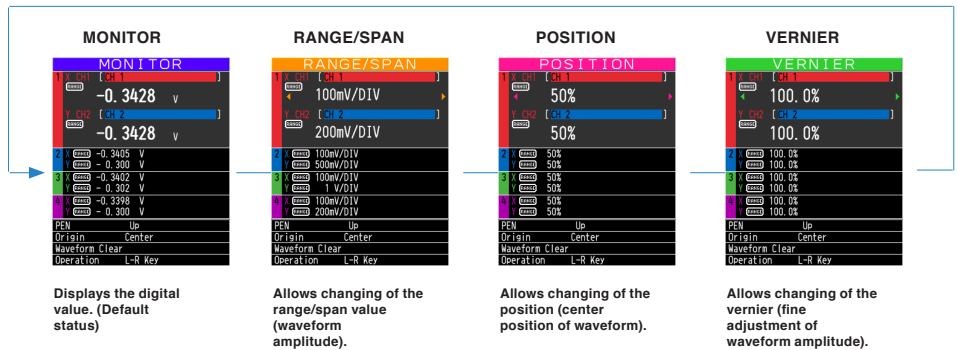

- L-R key mode
 - Use [CH SELECT] key or ▲ ▼ keys to move XY-CH and axis.
 - Use ◀ ▶ keys to change the contents of the selected XY-CH and axis.
- Cross key mode
 - Use [CH SELECT] key to move XY-CH.
 - Use the ◀ ▶ keys to change the contents of the X-axis, and use ▲ ▼ keys to change the contents of the Y-axis.
 - (In the Quick setting area, use ◀ ▶ keys to change the contents.)

(3) TIME/DIV

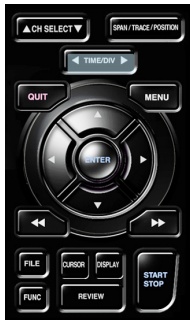

Press the [TIME/DIV] key to change the time axis display width.

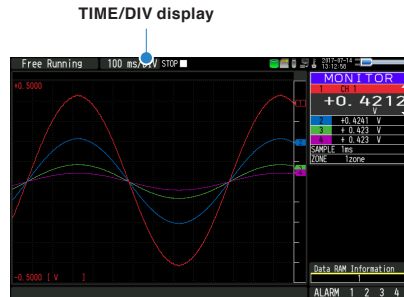

(4) MENU

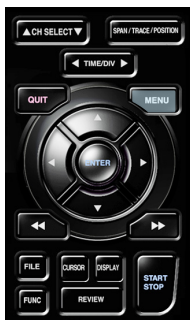

Open the settings window to capture data. For details on settings, refer to “3.5 Setting Menus”.

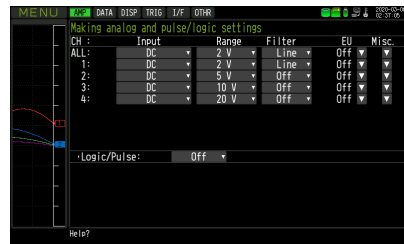

* For details of remote lock release function, refer to GL-Connection User's Manual.

(5) QUIT (LOCAL)

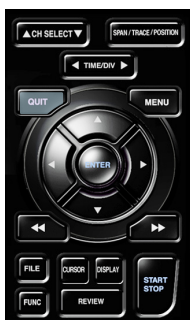

This key is primarily used for the following operations.

- To cancel a setting during menu configuration.
- To return to the MONITOR screen when the SPAN/TRACE/POSITION screen is displayed.
- To cancel remote status (When the keys are disabled) through interface control.
- To close the menu screen.
- To quit data replay.
- To stop drawing the XY replay waveform.
- To clear the Real time statistical calculation. (during free running mode)

(6) Direction Keys



This key is primarily used for the following operations.

- To move a menu or setting item during menu configuration.
- To move the cursor during replay.
- To move the active channel in the “Digital display” and “Logging screen” (▲ ▼ keys).
- To change the setting of SPAN/TRACE/POSITION (◀▶ keys).
- To change the Quick setting (◀▶ keys).
- To change the channel to be displayed on the “Logging screen” (◀▶ keys).

(7) ENTER



This key is primarily used for the following operations.

- To finalize setting items during menu configuration or open submenus.

(8) FAST FORWARD key (KEY LOCK)

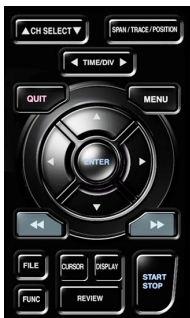

This key is primarily used for the following operations.

- To move the cursor at high speed during replay.
- To change the display order of the files in the file selection tool.
- To set key lock (Hold down the left/right FAST FORWARD key for at least two seconds. Press again to unlock)
 A password for canceling the key lock can be specified.
 For details, refer to “3.2 Key Operation” - “(15) Key lock release with password”.
- To change the display mode in the “Logging display” and “Real time statistical calculation display”.



- Select individual logic CH with Logic CH in Y-T digital display.



(9) START/STOP (USB Drive Mode)



This key performs the following two operations:

<Starts/stops capture>

- During Free Running, starts capture.
- During capture, stops capture.

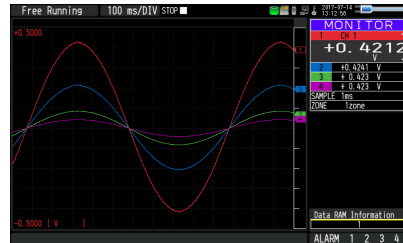

USB Drive Mode

In the “USB Drive Mode”, check the internal memory and SD card as external storage devices on the PC. They will be recognized as two external storage media.

Transfer and delete files since two external storage media are recognized as a removable disk.

1. Using a USB cable, connect to the PC.
2. To enter the USB Drive Mode, press down [START/STOP] key from when the power is turned on until the display below appears.
3. The external storage media is recognized by the PC and data exchange becomes possible.

* In USB Drive Mode, the display on this device becomes as follows:



CAUTION

- To exit USB Drive Mode, turn off and turn on the power again.
- During USB Drive Mode, no operation including data capture and data replay is available.
- USB memory does not conform to USB Drive Mode.

(10) REVIEW

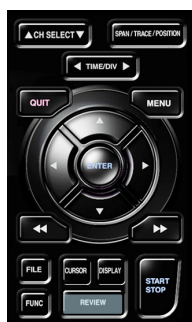

This key is used to replay captured data.

- During Free Running, captured data is replayed.
Display the "Data Replay Source" screen, and then set the internal RAM data or file you want to replay.

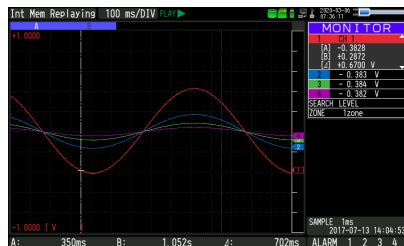

- While capturing data, real-time recorded data is replayed.

<Replaying display during data capture>

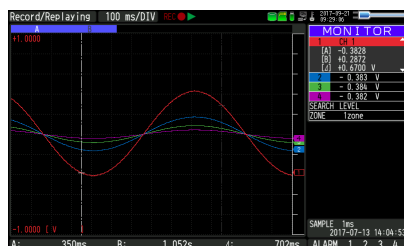

To exit the replay display, press the [QUIT] key.

CAUTION

For CSV-formatted data, only the data captured by this device can be displayed.

Also, when the data recorded in CSV format is replayed, the unit of the temperature data is displayed in “deg C” rather than “°C” format.

11) DISPLAY

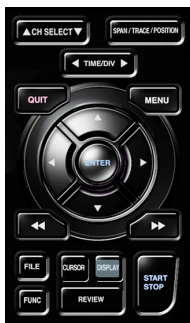

The key is used to switch the screen mode.

When running Free Running (when the capturing is stopped) mode, the screen mode can be switched between data capturing and data replaying.

Pressing this key switches the screen display as follows:

<When Free Running and data capturing>

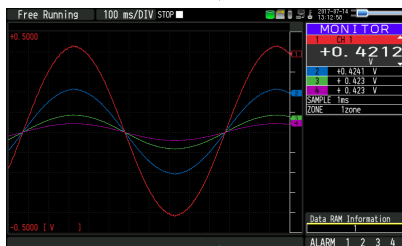

<Waveform + Digital display>

Displays the Y-T waveform and the Digital display.

Settings can be changed using the [SPAN/TRACE/POSITION] key.

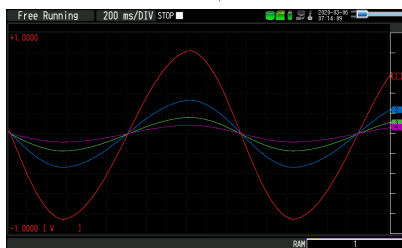

<All waveform screen>

Displays only the waveform in full screen mode.

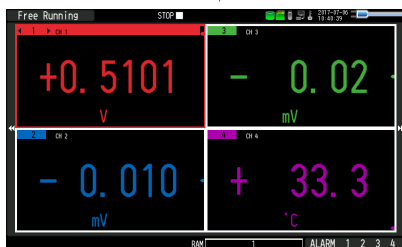

<Logging display + Real time statistical calculation screen>

Logging display and Real time statistical calculation screen in letters.

Use the ◀◀▶▶ FAST FORWARD keys to change the display mode. The calculation results are displayed only when switched to "Real time statistical calculation screen".

Refer to "3.2 Key Operation" - "(8) FAST FORWARD key (KEY LOCK)" for details on "Real time statistical calculation screen".

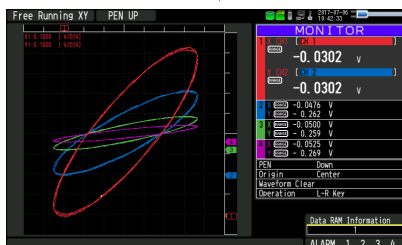

<XY screen>

Displays XY waveform and XY digital display.

In addition, You can change the settings" using SPAN/TRACE/ POSITION" key.

(12) CURSOR (ALARM CLEAR)



- This key is used to switch between cursor A and B during replay. Pressing this key switches between cursor A and B. For details on cursor operation, refer to “3.5 Setting Menus” - “(8) Data replay menu”.

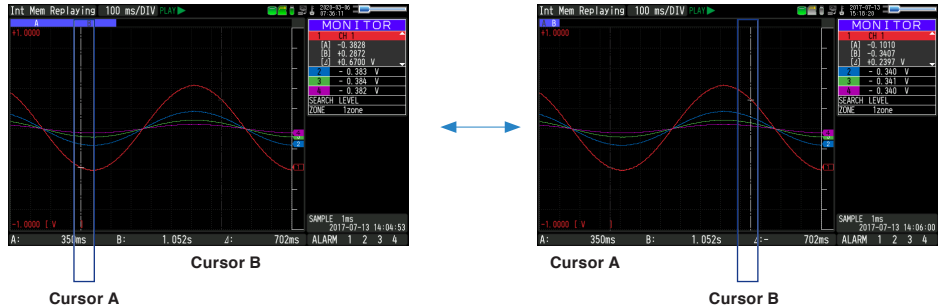

- When the alarm setting is “Hold generated Alarm”, the alarm on hold is cleared.

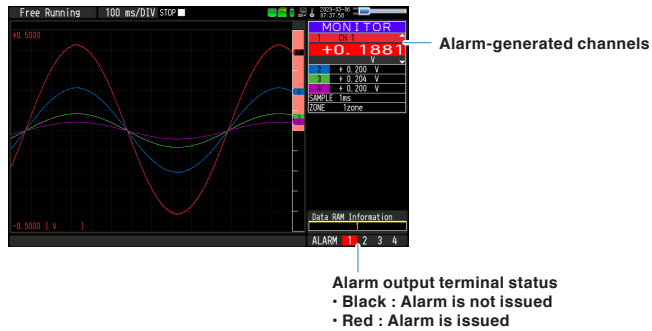

(13) FILE



- This key is used to execute file-related operations.
- Performs the operations (copy, delete, and transfer, etc.) for the internal memory, SD card and USB memory.
 - Execute the screen copy
 - Saves all data or data between cursor A and cursor B during replay (set during replay only)
 - Saves the data in the internal RAM to a file.
 - Saves or reads the current set conditions. (can be set during Free Running only).
 - Replaces the SD card or USB memory during data capture (Can be set when data is being backed up).
- For details on the file operation, refer to “3.5 Setting Menus” - “(7) FILE menu”.

(14) FUNC

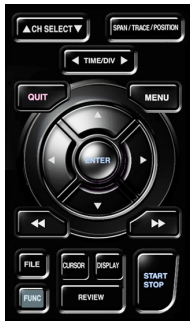

Execute the function operation.

Take a shortcut with the key by selecting the frequently used function in advance. In addition, selection can be made anytime.

For details of function operation, refer to "3.5 Setting Menus" - "(6) OTHER settings" - "FUNC key settings".

Shortcut execution mode: The set operation is executed immediately (shortcut execution).

Selection execution mode: Select the operation you want to execute and then execute it.

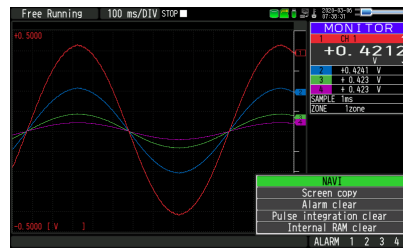

Using the ▲ ▼ keys, select the execution content that you can select and then press the ENTER key to execute it.

(15) Key lock release with password

A password can be set to cancel the key lock.

(No password is set at factory default.)

<Operation flow>

1. Set the password.

Press the ◀, ▶, and [ENTER] keys at the same time to display the password setting screen shown below. Specify a 4 digit password.



Use the ◀, ▶, ▲, ▼ keys to select numbers. Press the [ENTER] key to confirm the password.

Specifying 0000 will disable password operation.

In case you forgot your password, please contact us for the master password.

2. Set the password.

Hold down the ◀◀ and ▶▶ keys together for at least two seconds.

3. Cancel the key lock.

Hold down the ◀◀ and ▶▶ keys together again for at least two seconds.

The password setting screen shown below will be displayed. Set a password.



Entering an incorrect password will not cancel the key lock.

Key lock state will be retained when power is turned off.

3.3 Description of the display mode

(1) Y-T waveform display

The Y-T waveform is a graph in which the vertical axis is measured value (Y) and the horizontal axis is time (T).

The horizontal axis (T) can be adjusted by Time/DIV setting. Adjust the display width of the horizontal axis (T) of the waveform by changing this value.

With the vertical axis (Y), display position and display width can be adjusted by range setting, span setting (position setting) and zone setting.

The graph waveform can be turned On/Off by trace setting. Even when trace (display) is off, the data can be saved in the internal RAM, internal memory, SD card, USB memory.

Display format

The Y-T waveform display screen has two display formats.

● Waveform + Digital display

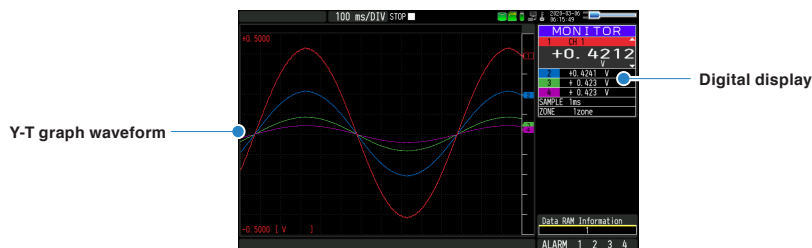

Using Y-T graph waveform on the left side and digital value on the right side, currently measured values can be monitored.

● Full waveform screen

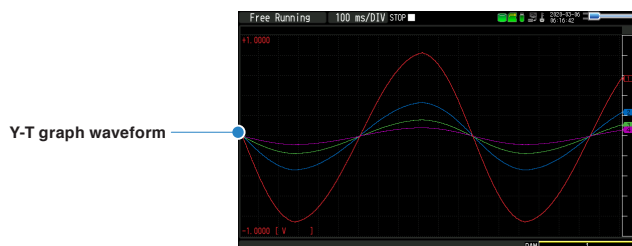

With this display format, you can display the time axis of Y-T graph waveform can be views wider by hiding the digital display.

Zone division

Zone division is a function to divide the Y-axis of the Y-T graph into multiple zones and display them so that the graphs do not overlap.

Select from 1-zone (no zone division), 2-zone division, 4-zone division or 8-zone division.

* For 4-zone division and 8-zone division, 4DIV above and below the center is used for display.

Analog CH and pulse CH can be freely allocated to each zone.

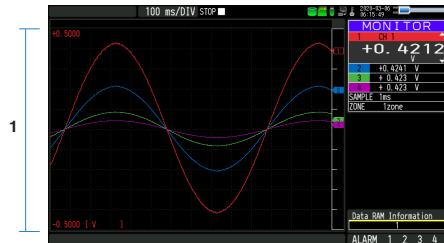

1-zone (no zone division)

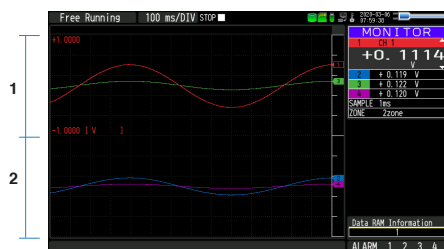

2-zone division

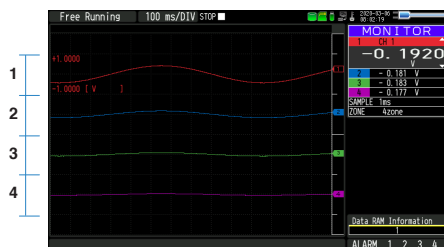

4-zone division

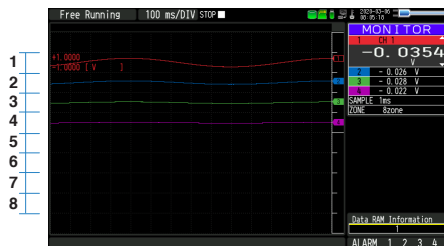

8-zone division

For Logic CH, 10 zones are provided in advance, so you can select the zone to display the Logic CH waveform.

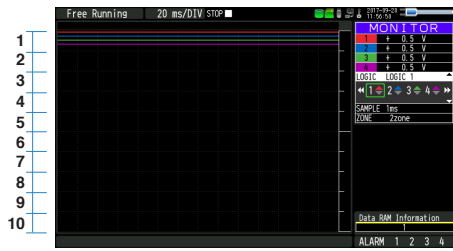

10-zone division



Active CH (priority display CH)

Active CH is a CH that displays over the other CHs.

The CH selected in the digital display is the active CH.

The active CH is displayed above the other CH, giving you easier view of the individual channel.

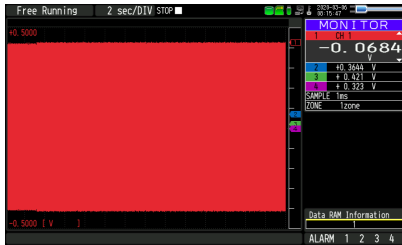

CH1 is active CH.
Since the waveform of CH 2 is hidden under the waveform of CH1, it cannot be visually recognized.



CH2 is active CH.
The waveform of CH2 is displayed on the top, so you can visually recognized it.

Time/DIV

Time/DIV is a function that you can enlarge or shrink the horizontal axis (T) of the Y-T graph waveform.

Set the time with one grid of graph.

The shorter the set time, the larger the horizontal axis (T).

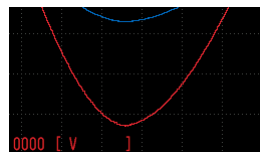
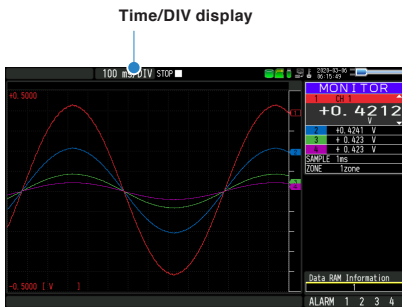

Set time with one grid of graph.

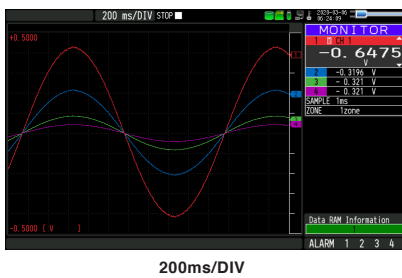

200ms/DIV

Enlarge
Shrink

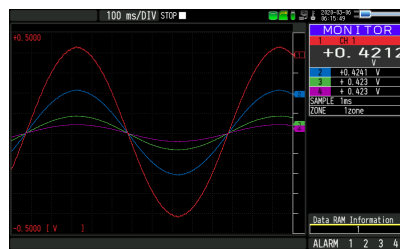

100ms/DIV

Use DISP menu and [TIME/DIV] key to set Time/DIV.

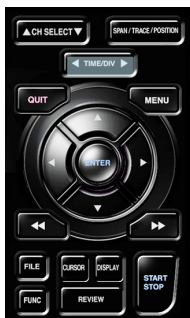

Span

Span is a function to set measurement value of the upper and lower edges in the zone.

By using the span setting, you can enlarge or shrink the vertical axis (Y) of the Y-T graph waveform.

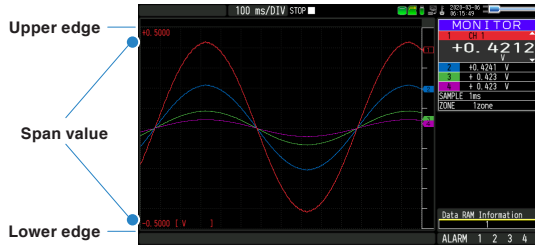

The span value is displayed as the scale display of the CH set to the active CH.

Span value can be changed in the AMP menu. You can perform simple Settings from the digital display.

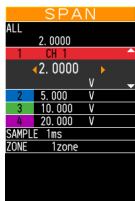

In the Span setting, use the ◀▶ keys to change the amplitude of the span. Smaller the amplitude value, wider the graph waveform displayed.

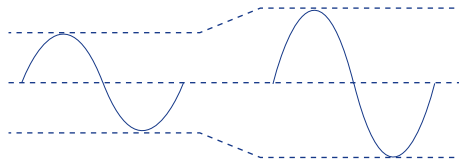

In Position setting, use the ◀▶ keys to move the span in parallel.

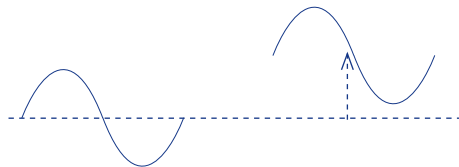

Digital display

The digital display is seen on the right side in the "Waveform + Digital display".

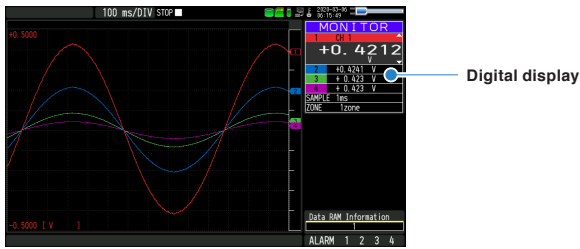

The digital display has the following functions.

- See the measured value with a digital value.
- Show CH where the alarm occurred.
- Sets active CH.
- Performs simple setting of SPAN, POSITION and TRACE.
- Operates Quick setting.

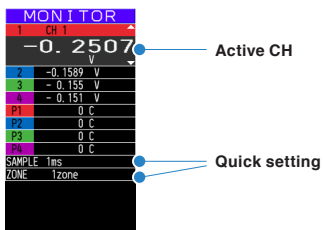

CAUTION

The CH where the input is set to Off does not display on the waveform.

Digital display of measured value

<Analog CH/Pulse CH>

During Free running/capturing

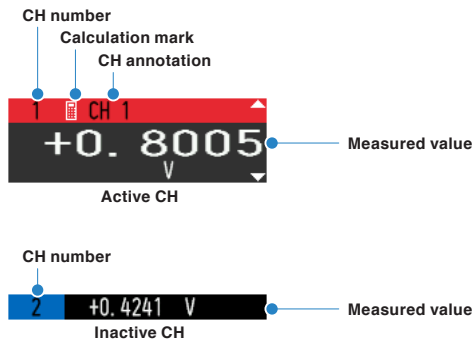

CH number : Measured CH number.

Calculation mark : Displayed when calculation between channels is set.

CH annotation : An annotation set to CH is displayed. When the number of annotation characters is larger than the display area, all the character strings are displayed by scrolling to the left.

Measured value : Current measured value (instantaneous value) is displayed.

When an alarm triggers the measured values are highlighted in red



During replaying

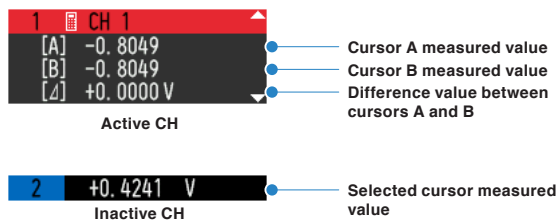

Cursor A measured value : The measured value of the data pointed where cursor A is located is displayed.

Cursor B measured Value : The measured value of the data pointed where cursor B is located is displayed.

Difference value between cursors A and B : The difference of measured values between cursor A and B is displayed. When cursor A is selected, value from B value to A is displayed, and when cursor B is selected, value from A value to B value is displayed.

Selected cursor measured value : The measured value of the data pointed to the current selected cursor is displayed.

<Logic CH>

- During Free running/capturing

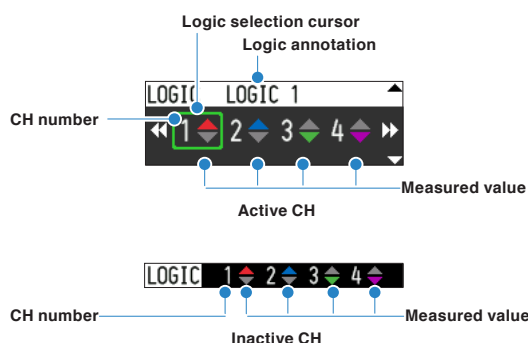

CH number : Logic CH number

Logic annotation : Annotation of the logic CH selected by the logic selection cursor is displayed.

Logic selection cursor: Select individual logic CH. Use ◀◀ and ▶▶ keys to move on the logic CH.

Measured value : The measured value of the logic CH is displayed.



: High level



: Low level

- During replay

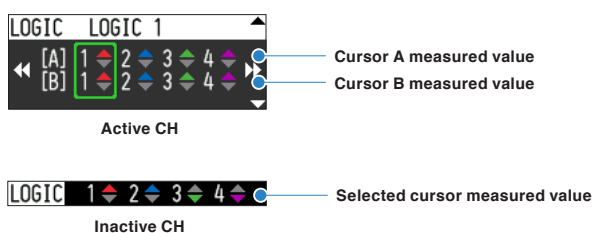

Cursor A measured value : The measured value of the data pointed by cursor A is displayed.

Cursor B measured Value : The measured value of the data pointed by cursor B is displayed.

Selected cursor measured value : The measured value of the data pointed to the current selected cursor is displayed.

Set active CH

Switch between the active CH by operating the [CH SELECT] key or the ▲ ▼ keys.

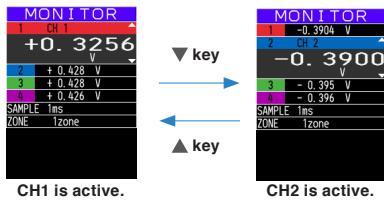

Simple setting of SPAN /POSITION/TRACE

Choose each setting by pressing the [SPAN/TRACE/POSITION] key.

Y-T screen

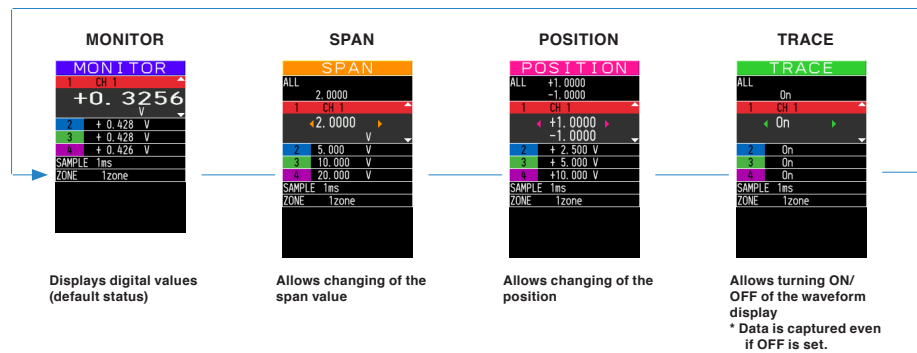

Use [CH SELECT] key or the ▲ ▼ keys to move on the CH.

Change the contents of the CH selected with the ◀▶ key.

* When ALL is set, setting values for CH1 is reflected on other channels.
When CH1 is OFF, ALL cannot be set.

* When Logic CH is selected in "MONITOR" or "TRACE", use ◀◀ and ▶▶ keys to select individual CH of logic.



Quick setting

Quick setting is a function that you can perform the settings in the digital display without opening the setting menu.

- Sampling interval (SAMPLE)



You can change the sampling interval setting.

Use the ◀▶ keys to change it. However, you can only change it only while Free running is executed. You cannot change it during capturing. The sampling interval is not displayed during replaying.

When changing the sampling interval, the Time/DIV value may be changed depending on the limitation.

- Zone division (ZONE)

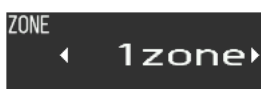

The number of zone divisions can be changed.

Use the ◀▶ keys to change setting. When changing the number of zone divisions, setting of CH allocated to the zone is displayed.

You can change the number of zone divisions at any time.

- Search (SEARCH)



Performs waveform search according to the level search conditions set in the Data Replay menu during replaying.

Use ◀ key to search the past data and use the ▶ key to search future data from the current set point.

Before using this function, set the search level from the Data Replay menu.

(2) Logging display/real time statistical calculation display

The logging display is a function to digitally display the current measured value with large fonts on the display screen.

Visibility is improved by use of large fonts.

Real time statistical calculation display is a function to calculate and display maximum value, minimum value, P-P value, and average value. Use DISP menu, [FUNC] key function and [QUIT] key to clear the statistical calculation during Free running.

Additionally, the statistical calculation is cleared when capturing is started.

To switch between display modes, press the ◀◀ and ▶▶ keys.



Besides the real time statistical calculation display, the following key operations are possible.

Use [CH SELECT] key or the ▲ ▼ keys to move on the selected section.

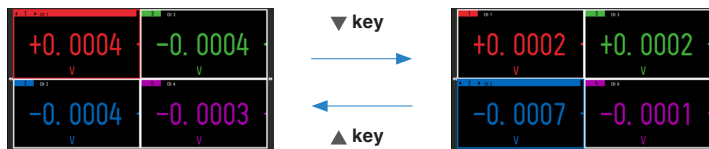

Use the ◀▶ keys to change the CH displayed on the selected section.

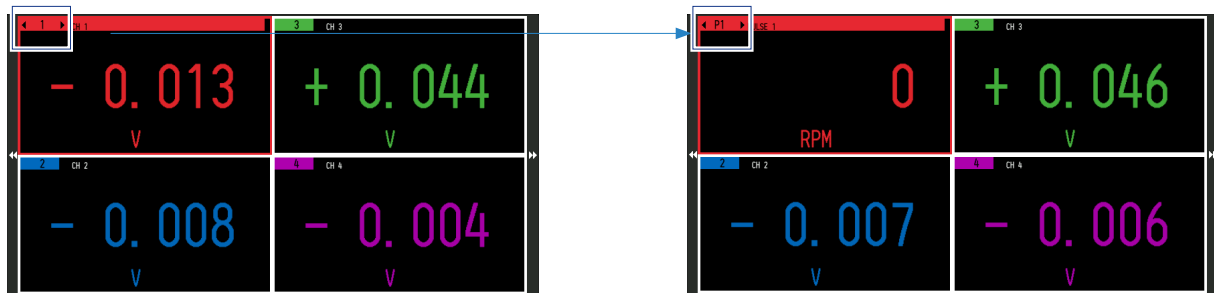

Logging display



- CH number : Measured CH number.
- Calculation mark : Displayed when calculation between channels is set.
- CH annotation : Annotation set to CH is displayed.
- Measured value : Currently measured value is displayed.
- Level indication : Level position of measured value is displayed with a pointer.

Real time statistical calculation display

CH	VALUE	Max	Min	P-P	Ave
CH1	+0.5101 V	+0.5102	+0.5101	+0.0001	+0.5101
CH2	-0.010 V	-0.009	-0.012	+0.003	-0.010
CH3	-0.02 V	-0.02	-0.03	+0.01	-0.02
CH4	+33.4 V	+33.4	+33.2	+0.2	+33.3

Analog CH only

CH	VALUE	Max	Min	P-P	Ave
CH1	-0.4025 V	+0.4151	-0.4120	+0.8271	+0.0008
CH2	-0.3993 V	+0.4161	-1.0823	+1.4983	-0.0143
CH3	-0.398 V	+0.417	-1.130	+1.547	-0.015
CH4	-0.394 V	+0.420	-1.129	+1.549	-0.015

Analog CH + Logic CH

CH	VALUE	Max	Min	P-P	Ave
CH1	-0.3506 V	+0.4151	-0.4120	+0.8271	+0.0008
CH2	-0.3435 V	+0.4161	-1.0823	+1.4983	-0.0143
CH3	-0.337 V	+0.417	-1.130	+1.547	-0.015
CH4	-0.333 V	+0.420	-1.129	+1.549	-0.015
CH5	0 V	0	0	0	0
CH6	0 V	0	0	0	0
CH7	0 V	0	0	0	0
CH8	0 V	0	0	0	0

Analog CH + Pulse CH

CH	VALUE	Max	Min	P-P	Ave
1	+0.7562 V	+0.8304	-2.1604	+2.9907	-0.0303

- CH number : Measured CH number.
- Calculation mark : Displayed when calculation between channels is set.
- CH annotation : Annotation set in CH is displayed.
- Measured value : Currently measured value is displayed.

<Statistical calculation value>

Use DISP menu, [FUNC] key and [QUIT] key to clear the statistical calculation during Free running. Also, the statistical calculation is cleared when the capturing is started.

- Maximum value : Maximum value after clearing
- Minimum value : Minimum value after clearing
- P-P value : A value between the maximum value and minimum value.
- Average value : Average value after clearing

(3) XY waveform display

XY waveform display is a function to show a graph with measured values for both the horizontal X-axis and the vertical Y-axis.

Since the graph is drawn based on measured values of CH set on the horizontal axis and vertical axis, it allows to check the correlation between both data graphically.

XY waveform display mode has RANGE mode, SPAN mode, POSITION dedicated to XY and VERNIER functions.

Setting operation is much like the operation of the XY pen recorder

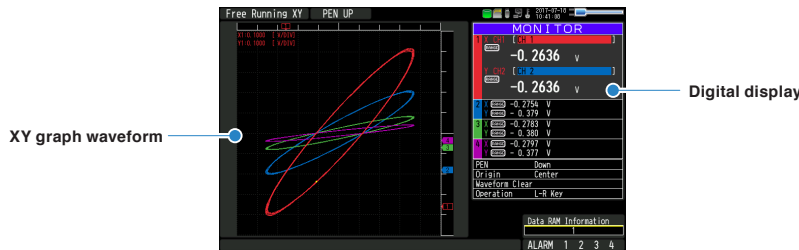

RANGE mode/SPAN mode

This device has RANGE and SPAN mode.

RANGE mode: Switches to the optimum range (amplifier sensitivity) in conjunction with the FS (full scale) range set in the AMP menu.



SPAN mode: Sets the span width when using temperature and humidity, EU function, calculation between CHs function.

Refer to the following table to see which mode is set in various settings.

Input	EU	Calculation between CHs	Mode
Voltage	Off	Off	Range
	On	Off	Span
	Off	On	Span
	On	On	Span
Root mean square value	Off	Off	Range
	On	Off	Span
	Off	On	Span
	On	On	Span
Temperature	-	-	Span
Humidity	-	-	Span

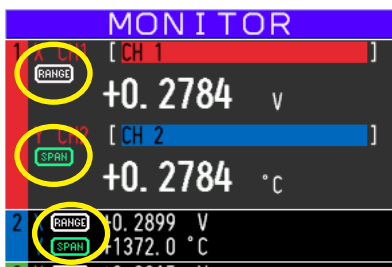
The mode that is operating currently is displayed on the digital screen.



-  : RANGE mode
-  : SPAN mode

The differences in XY digital display operation are as follows.

Mode	RANGE/SPAN	POSITION	VERNIER
RANGE	Use the ◀▶ keys to change the V/DIV range. The V/DIV range cannot be changed during replay.	Position reference point is 0V or 0Vrms.	100 to 50% (40%)
SPAN	Use the ◀▶ keys to change the Span width. The Span width cannot be changed during replay.	Position reference point is the center point of the span.	100 to 40%

In RANGE mode, the relationship between the FS range displayed by the AMP setting and the V/DIV range displayed on the XY digital display are as follows. In addition, the VERNIER setting range in each range is as shown in the following table.

FS range	V/DIV range	Vernier setting range
20mV	1mV/DIV	100% to 50%
50mV	2mV/DIV	100% to 40%
100mV	5mV/DIV	100% to 50%
200mV	10mV/DIV	100% to 50%
500mV	20mV/DIV	100% to 40%
1V	50mV/DIV	100% to 50%
2V	100mV/DIV	100% to 50%
5V	200mV/DIV	100% to 40%
10V	500mV/DIV	100% to 50%
20V	1V/DIV	100% to 50%
50V	2V/DIV	100% to 40%
100V	5V/DIV	100% to 50%
200V	10V/DIV	100% to 50%
500V	20V/DIV	100% to 40%
1000V	50V/DIV	100% to 50%

FS range	V/DIV range	Vernier setting range
10mVrms	0.5mVrms/DIV	100% to 50%
25mVrms	1mVrms/DIV	100% to 40%
50mVrms	2.5mVrms/DIV	100% to 50%
100mVrms	5mVrms/DIV	100% to 50%
250mVrms	10mVrms/DIV	100% to 40%
500mVrms	25mVrms/DIV	100% to 50%
1Vrms	50mVrms/DIV	100% to 50%
2.5Vrms	100mVrms/DIV	100% to 40%
5Vrms	250mVrms/DIV	100% to 50%
10Vrms	500mVrms/DIV	100% to 50%
25Vrms	1Vrms/DIV	100% to 40%
50Vrms	2.5Vrms/DIV	100% to 50%
100Vrms	5Vrms/DIV	100% to 50%
250Vrms	10Vrms/DIV	100% to 40%
500Vrms	25Vrms/DIV	100% to 50%
1000Vrms	50Vrms/DIV	100% to 50%

Since the RANGE affects the hardware operation (amplifier sensitivity), it cannot be altered during capturing or replaying.

The RANGE setting is common to the RANGE setting of the Y-T graph.

The display amplitude of the waveform is determined by the range and X-Y dedicated position, and Vernier settings, without span setting of Y-T graph.

In SPAN mode, the SPAN can be changed within the same range as the Y-T graph.

Set the SPAN in RANGE/SPAN display of XY digital display with ease. In addition, details can adjusted using the AMP menu setting or DISP menu setting.

It is common to use span setting of Y-T graph.

XY position

In the position function of XY graph display (hereinafter XY position), set the drawing position reference point to 0% for the lower left corner and 100% for the upper right corner of the XY graph.

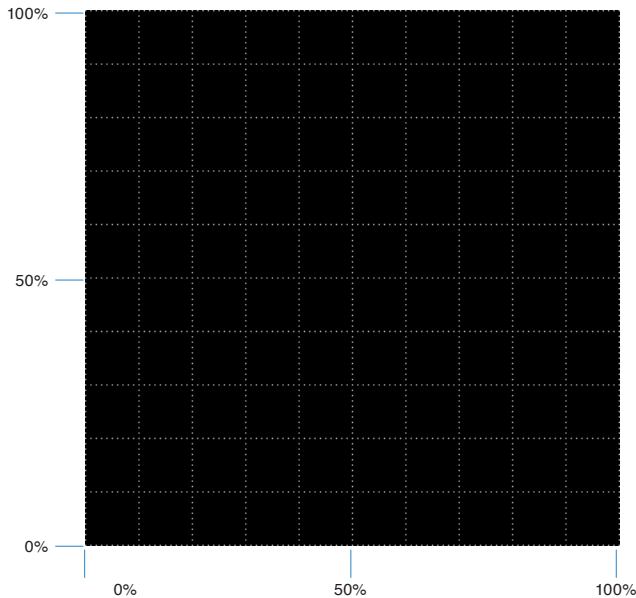

The measurement range displayed on the graph by the XY position setting is as follows.

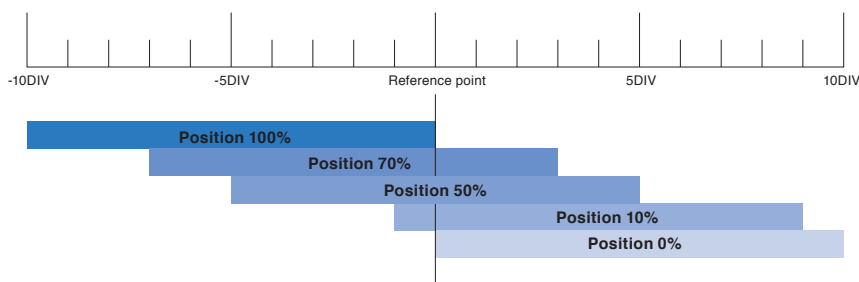

As shown in the above figure, the display range moves in parallel with 10DIV area with the XY position setting.

XY position setting is used for XY graph setting only.

Position reference point differs between RANGE mode and SPAN mode.

- RANGE mode

The position reference point in RANGE mode is 0V or 0Vrms.

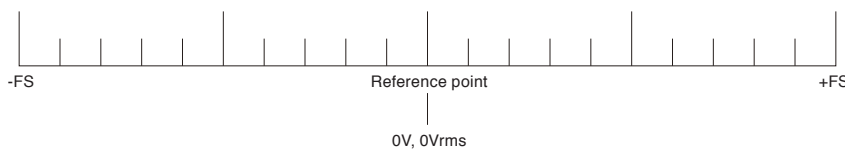

- SPAN mode

The position reference point in SPAN mode is the center point between the upper limit span value and the lower limit span value.

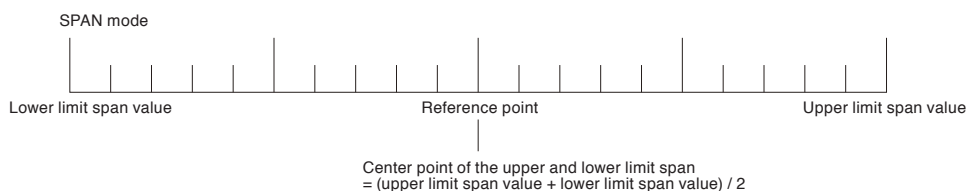

When setting the XY position, a position reference line (pink line) indicating the position reference value is displayed.

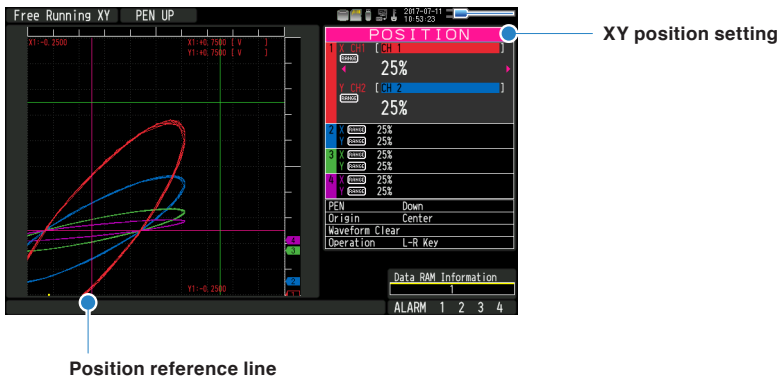

VERNIER

The VERNIER is a function to adjust the amplitude (gain).

Adjust the display width range of the waveform displayed on the XY graph.

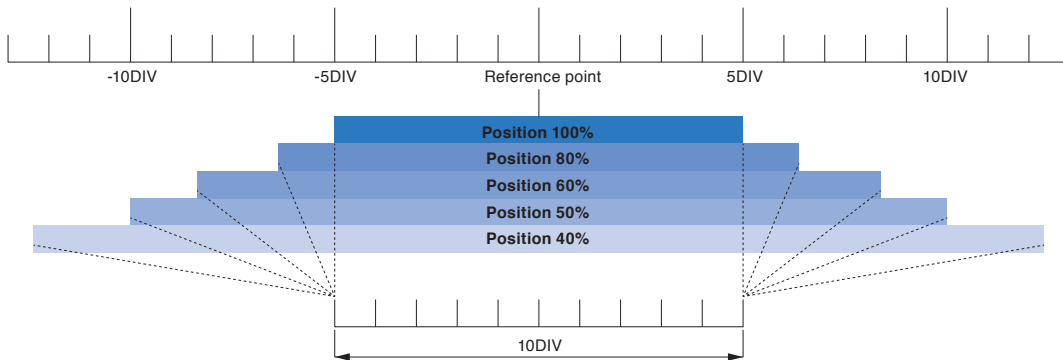

When the VERNIER is set to 100%, it becomes an equal magnification. Therefore the waveform display is shrunk by the VERNIER setting magnification.

For example, when the VERNIER is set to 80%, it is displayed with a size of 80% compared with 100%.

(The above figure shows the sample when the XY position is set to 50%)

During VERNIER setting, a VERNIER reference line (green line) pointing to the VERNIER magnification is displayed.

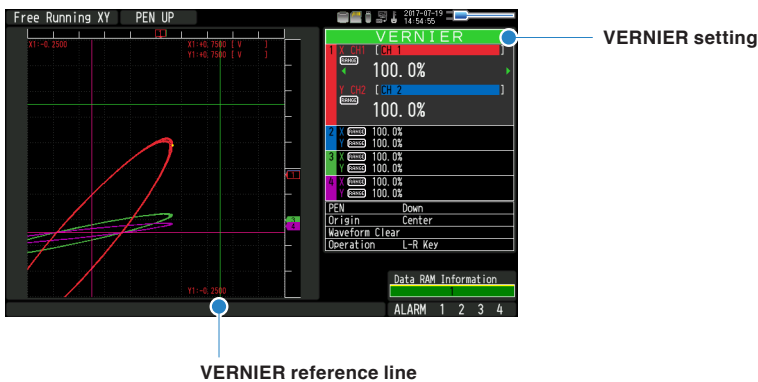

The VERNIER reference line is displayed at the position of 5DIV from the position reference point when the VERNIER is set to 100%. When the VERNIER is set to 80%, it is displayed at the position of 4DIV from the position reference line (80% position compared with 100%).

XY digital display



The XY digital display has the following functions.

- Displays the measured value as a digital value.
- Active XY-CH setting.
- RANGE/SPAN/POSITION/VERNIER setting.
- Quick setting

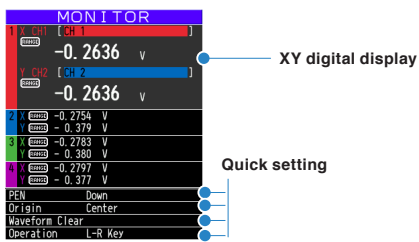

CAUTION

XY-CH which TRACE is set to Off is not displayed.

Digital display of measured value

- During Free running/Capturing

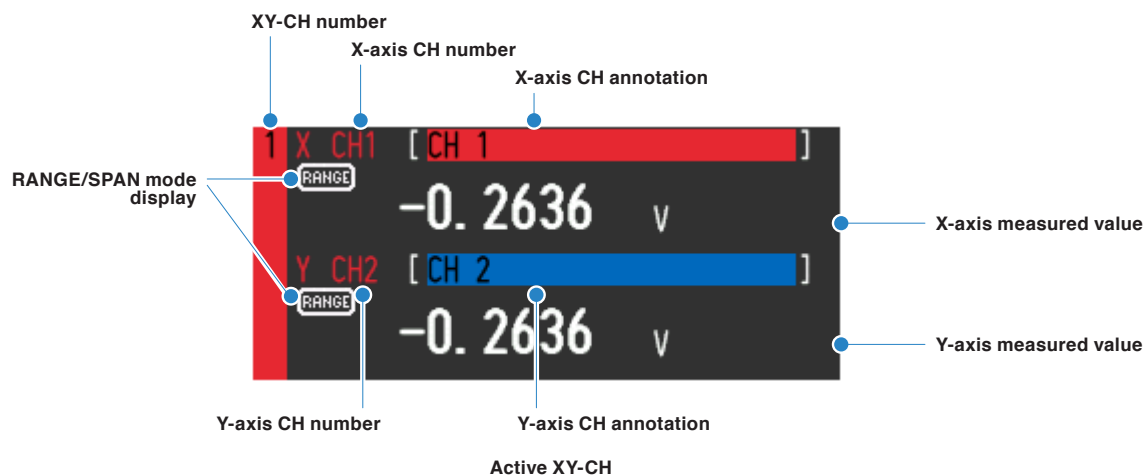

- XY-CH number : XY-CH number.
- RANGE/SPAN mode display : Displays the selected CH operating in RANGE mode or SPAN mode.
- X(Y)-axis CH number : Analog CH number set on the X(Y)-axis.
- X(Y)-axis CH annotation : Annotation of the analog CH set on the X(Y)-axis is displayed. When the number of annotation characters is larger than the display area, all the character strings are displayed by scrolling to the left.
- X(Y)-axis measured value : Current measured value (instantaneous value) is displayed.

- During replays

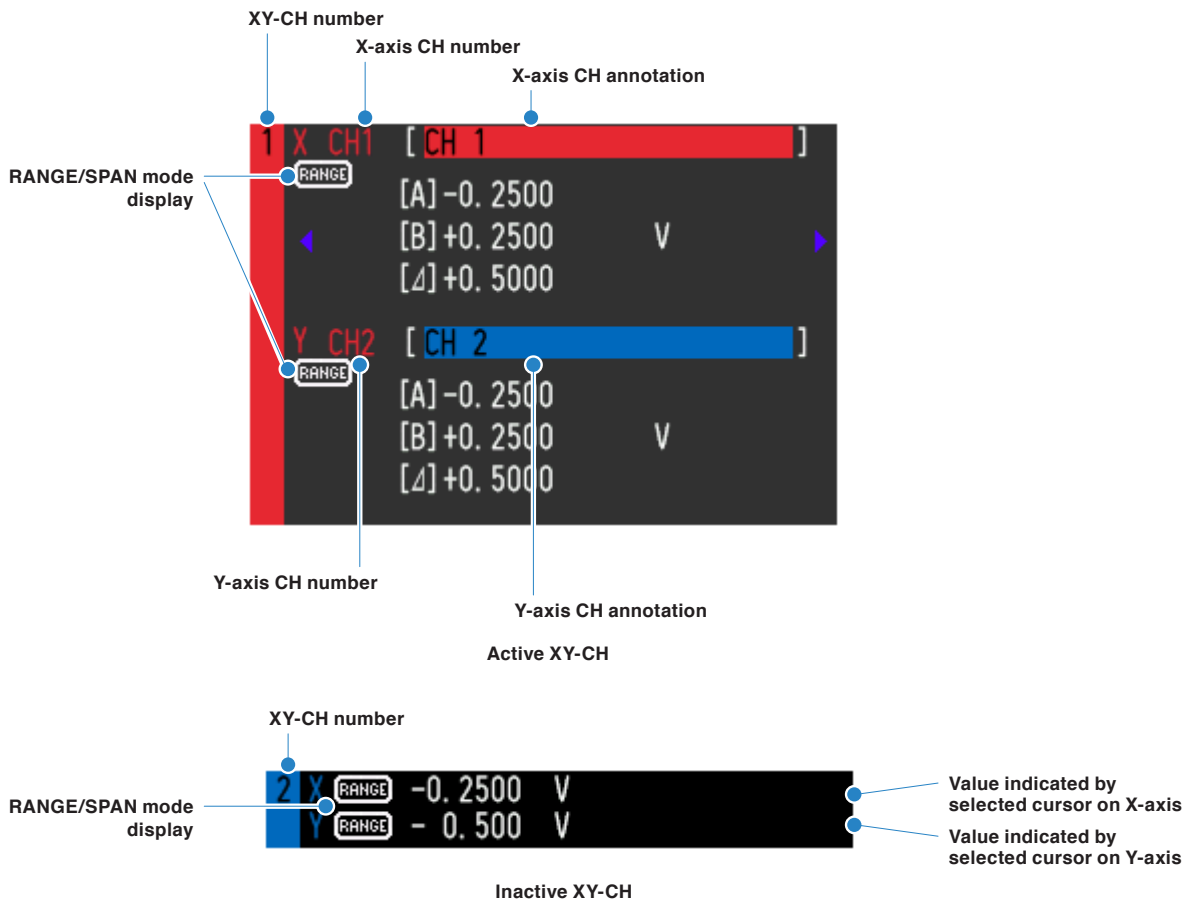

- XY-CH number : XY-CH number
- RANGE/SPAN mode display : Displays which CH is operating in the RANGE mode or the SPAN mode.
- X(Y)-axis CH number : Analog CH number set to the X(Y)-axis.
- X(Y)-axis CH annotation : Annotation of the analog CH set to the X(Y)-axis is displayed. When the number of annotation characters is larger than the display area, all the character strings are displayed by scrolling to the left.
- X(Y)-axis cursor A (B) indication value : The indication value on the graph designated by each cursor is displayed.
- Value differences between cursor A and B on X(Y)-axis : Displays the difference of measured values between cursors A and B. When cursor A is selected, B-A value is displayed. When cursor B is selected, A-B value is displayed.
- Value indicating by selected cursor : The indication value on the graph designated by the current selected cursor is displayed.

L-R key mode and Cross key mode

XY digital display has 2 operation modes.

2 operation modes are L-R key mode with the same key operation as the Y-T waveform screen and Cross key mode optimized for operation of XY waveform screen.

- L-R key mode

Move XY-CH and axis with the [CH SELECT] key (hereafter CS key) or the ▲ ▼ keys.

Change the contents of XY-CH and axis selected with the ◀ ▶ keys.

While in "MONITOR" display, you can move the XY-CH with the CS key or the ▲ ▼ keys during Free running or capturing. (This does not apply during replaying even in "MONITOR" display.)

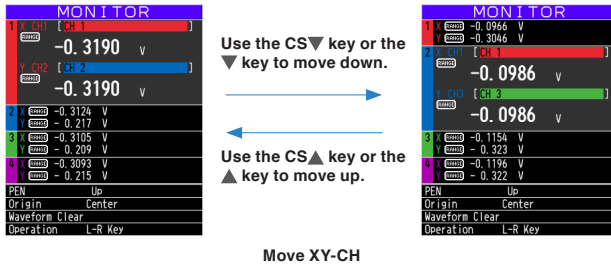

In addition to the above setting, use CS key or the ▲ ▼ keys move the axis. Then, press the same direction key to move between XY-CH channels.

* The contents sandwiched between ◀ and ▶ marks the active XY-CH.

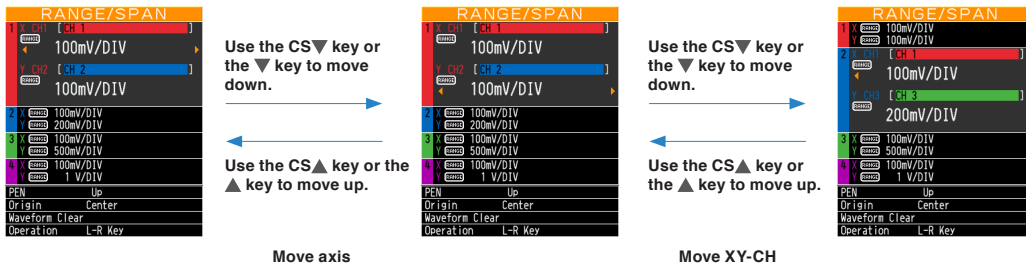

Change the setting contents of XY-CH/axis selected with the ◀ ▶ keys.

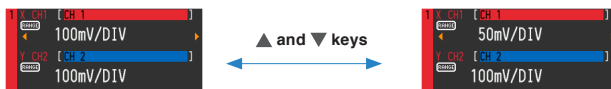

In the "MONITOR" display during replaying, the cursor moves on the selected axis. Move to decreases move /left (down) with the ◀ key, and to increases move /right (up) with the ▶ key.

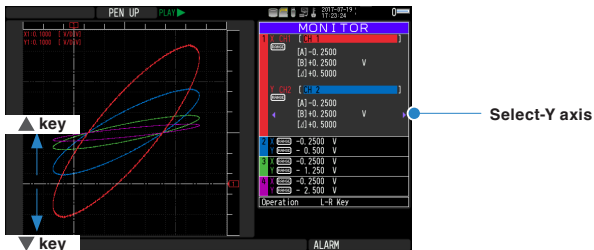

• Cross key mode

Move XY-CH with [CH SELECT] key (hereafter CS key).

Use the ◀▶ keys to change the contents of the X-axis, and use the ▲▼ keys to change the contents of the Y-axis.

(In Quick setting area, use the ◀▶ key to change contents.)

Use CS key to move XY-CH.



Change the setting contents of X-axis for XY-CH selected with the ◀▶ keys.

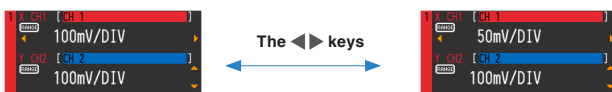

Change the setting contents of Y-axis for XY-CH selected with the ▲▼ keys.

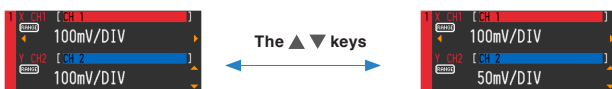

In the "MONITOR" display during replaying, you can move the cursor of the selected XY-CH. Use the ◀ ▶ keys to move the X-axis cursor, and use the ▲ ▼ keys to move the Y-axis cursor.

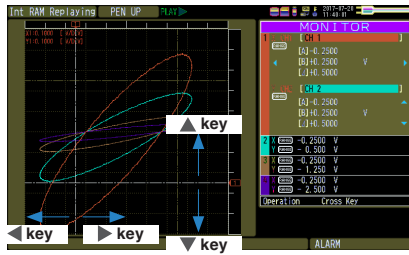

Simple setting of RANGE/SPAN/POSITION/VERNIER

Press [SPAN/TRACE/POSITION] key to perform each setting.

XT screen

MONITOR	RANGE/SPAN	POSITION	VERNIER
<p>Digital value is display. (Default status)</p>	<p>The RANGE/SPAN value (waveform amplitude) can be changed.</p>	<p>POSITION (center position of waveform) can be changed.</p>	<p>VERNIER (fine amplitude adjustment of waveform) can be changed.</p>

Quick setting

Quick setting is a function that can be set in the Digital display without opening the setting menu.

- Pen (PEN)



Operates the pen UP/DOWN.

Use the ◀▶ keys to change the state of UP/DOWN.

When the pen is in DOWN state, the trajectory of the pen is drawn in the XY graph waveform.

Pen down operation is forced during capturing.

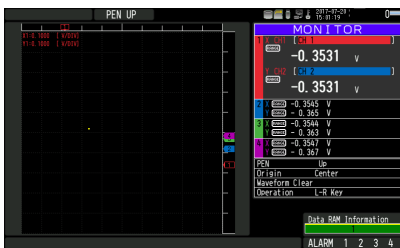

Pen UP state

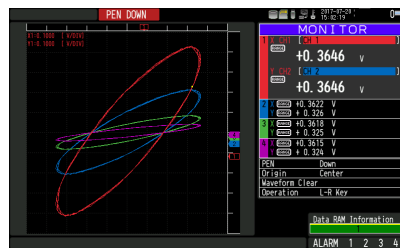

Pen DOWN state

- Origin



Initialize the XY position.

Select the Center of the XY graph or the Lower Left of the XY graph with the ◀▶ keys.

If [ENTER] key is pressed after selecting the origin, the XY position reference point moves to the selected position

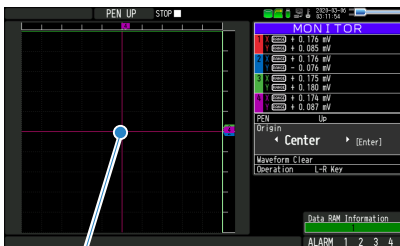

Origin Center

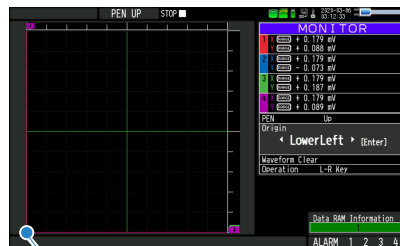

Origin Lower Left

- Waveform Clear



Erase the waveform (pen trajectory) in the XY graph.
Press [ENTER] key to erase it.

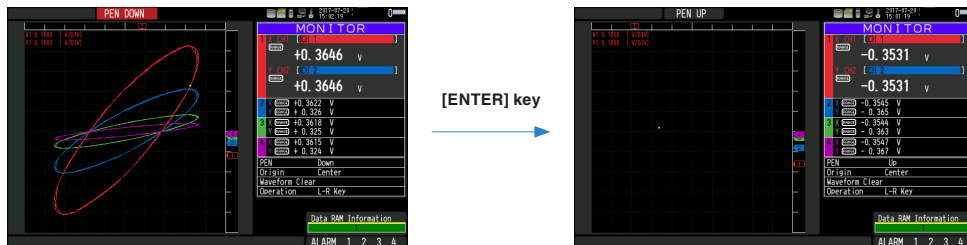

- Operation mode (Operation)



Switch the operation mode of the XY digital display.
Press the ◀▶ keys to switch the operation mode.

- L-R Key : L-R key mode
- Cross key : Cross key mode

XY overwrite display

When XY waveform display is used, you can display the saved ranges from the file menu as "Waveform screen" and the saved image file as the background image of the XY graph.

(Waveform screen image file not saved by this device are not available to view.)

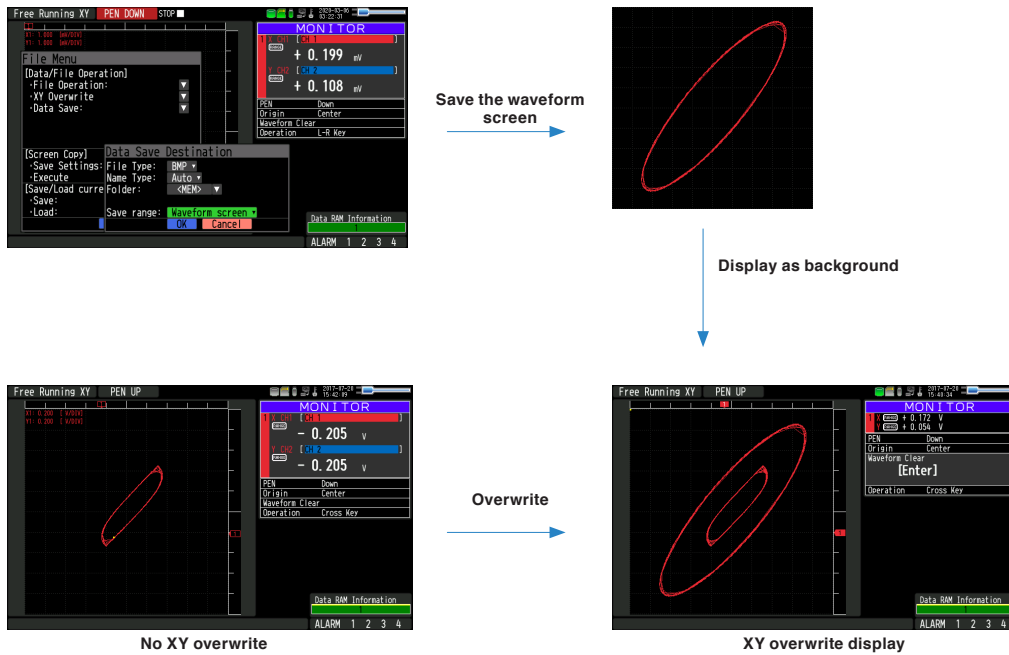

Background image to be overwritten is not erased even if operating the XY display clear.

Perform "Overwrite Clear" separately.

* Data is overwritten even during replaying.

CAUTION

Overwrite is a function to read image as image data in the background. Therefore, even if you change the XY position and VERNIER setting etc. for the waveform displayed in the background, it will not be reflected.

For details of XY overwrite setting, refer to "3.5 Setting Menus" - "(3) DISP menu" - "XY overwrite".

3.4 Operation Modes

Check the system operation status in the “Status Message”.

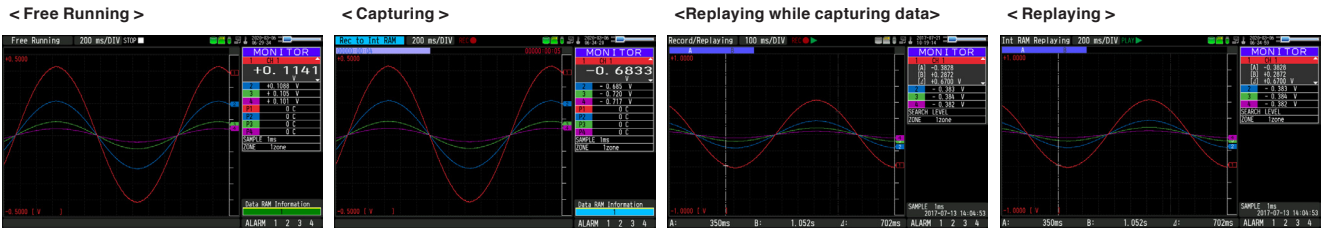

Operation	Description	Simple message display
Free Running	Startup status, or data is not being captured.	Free Running Free Running XY
Capturing	The data is being captured.	Capturing to internal RAM Capturing to internal memory Capturing to SD card Capturing to USB memory
Replaying while capturing data	Data being captured is being replayed.	Capturing and Replaying
Replaying	Captured data is being replayed.	Replaying from internal RAM Replaying from internal memory Replaying from SD card Replaying from USB memory

Operation status transition

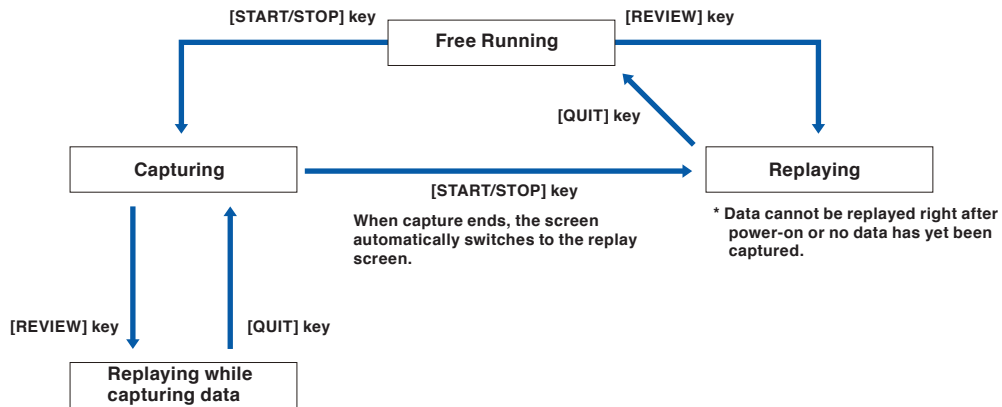

The operation modes are described using the Y-T + Digital display screen.

The basic operation is the same in other screen modes.

(1) Free Running

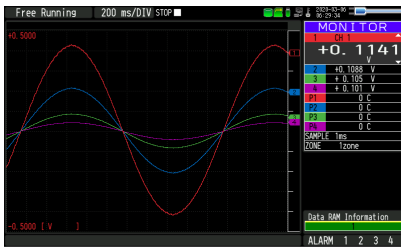

In Free Running, first start the settings for data capture.
The current input signal can be viewed in the waveform or digital value.

Main operations available during Free Running

Measurement condition setting change	The [MENU] key is used to change various setting items in setting menus.
SPAN/TRACE/POSITION change	The [SPAN/TRACE/POSITION] key is used to change settings.
Display mode switch	The [DISPLAY] key is used to change the display mode.
File operations	The [FILE] key is used to perform file-related operations.
Data replay	The [REVIEW] key is used to replay captured data.
Time axis change	The [TIME/DIV] key is used to change the time axis scale.

Operation of screen display

The information in the screen display can be changed by switching the channels.
The operation of screen display can be changed during Free Running, capturing, and replaying.

<Screen display when the CH1 is selected on the MONITOR screen during Free Running>

The scale of the selected channel is indicated.

The display channel can be switched by the ▲▼ keys.

The selected channel is displayed without coloration.

(2) Capturing

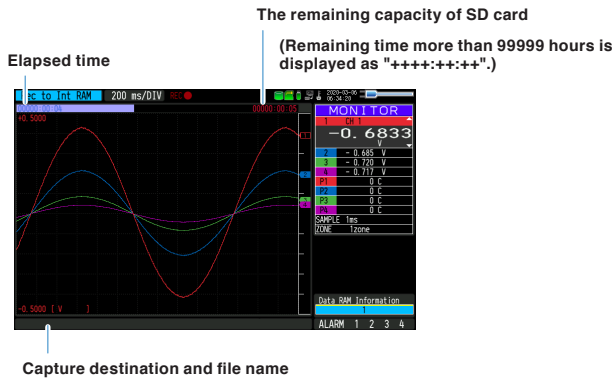

The captured data is saved in the Internal RAM, internal memory, SD card or USB memory during data capture.

You can not use the [MENU] key to change the setting.

Operations available during capture

SPAN/TRACE/POSITION change	Change the settings with the [SPAN/TRACE/POSITION] key.
Screen display mode switch	Change the screen mode with the [DISPLAY] key.
Replay while capturing	Replay the data captured while capturing
Save to device	Save to the device with the [FILE] key during data capture.
Setting check	Display the setting information with the [MENU] key.
Time axis change	Change the time axis with the [TIME/DIV] key.

(3) Data replay during capturing

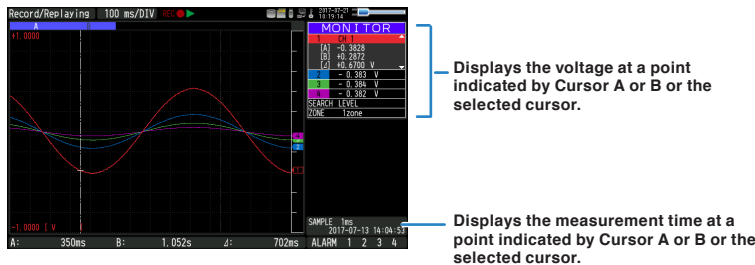

The captured data while capturing can be replayed by pressing the [REVIEW] key.

Use the Direction keys (◀▶) to move the cursor and captured data to check digital values.

Operations available during capturing

Cursor movement	The [CURSOR] key is used to switch between cursors A and B. The ◀▶ or ◀◀, ▶▶ keys are used to move the cursors.
Save to device	Recording save can be performed from the [FILE] menu. (The data up to the present or between the cursors can be saved in a separate file during data capture.)
Screen copy	Copy the screen with the [FILE] key.
Time axis change	Change the time axis with the [TIME/DIV] key.

CAUTION

- During ring capturing, the replay cannot be performed while capturing.
- During relay capturing, the data cannot be saved to a device.
- During relay capturing, the replay cannot be performed before the file is switched while capturing.

(4) Replaying

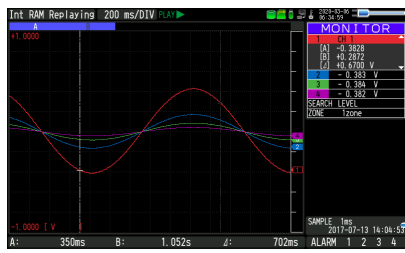

Displays the voltage at a point indicated by Cursor A or B or the selected cursor.

Displays the measurement time at a point indicated by Cursor A or B or the selected cursor.

Displays the captured data.

Main operations available during replaying

SPAN/TRACE/POSITION change	Change the settings with the [SPAN/TRACE/POSITION] key.
Operation in the menu during data capture	Perform cursor movement, data search and calculation setting with the [MENU] key.
Cursor movement	Switch between Cursor A and B with the [CURSOR] key. Using the ◀▶ or ◀◀, ▶▶ keys, move the cursor.
Data save	Save all the data or data between cursors with the [FILE] key.
Time axis change	Change the time axis scale with the [TIME/DIV] key.
File operation	Perform file-related operations
Display copy	Copy the screen with the [FILE] key.

⚠ CAUTION

For CSV-formatted data, only the data captured by the device can be replayed.

Also, when the data captured in CSV format is replayed, the unit of the temperature data is displayed as “deg C” rather than “°C”.

3.5 Setting Menus

When you press the [MENU] key during Free Running, the following menu screens appear.



(1) AMP settings

This menu is used to specify input signal-related settings.

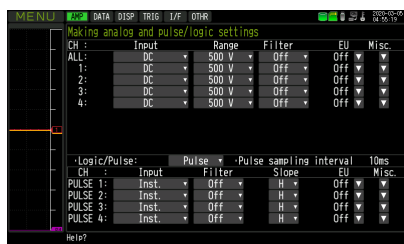

< Analog settings >

Setting		Selections available			
Input		Off, DC, RMS, TEMP, RH			
Range	[Voltage]	20, 50, 100, 200, 500mV; 1, 2, 5, 10, 20, 50, 100, 200, 500, 1000V; 1-5V			
	[RMS]	10, 25, 50, 100, 250, 500mVrms 1, 2.5, 5, 10, 25, 50, 100, 250, 500, 1000Vrms			
	[Temperature]	TC-K, TC-J, TC-T, TC-R, TC-E, TC-B, TC-S, TC-N, TC-W			
	[Humidity]	100% fixed			
Filter		Line, 5, 50, 500Hz, 5k, 50kHz			
EU (Scaling settings)	Function	Off, On			
	Dec pt	None, 1 digit, 2 digits, 3 digits, 4 digits after the decimal point			
	Meas. Value	Upper limit	Set numeric value.		
		Lower limit	Set numeric value.		
	EU value	Upper limit	Set numeric value.		
		Lower limit	Set numeric value.		
Select		Cur, Length, Area, Volume, Velocity, Accel, Freq, Mass, Energy, Pressure, Flow, Temp, Strain, Brightness, Concentration; Optional			
Unit		The selections vary depending on the unit selected in the above. (Enter arbitrary text: Up to 8 characters)			
Misc.	Annotation text string		Enter text. (Max. 31 characters)		
	Inter-CH Op Settings	Function		Off, On	
		Operation	Left-hand side	CH number	
			Operator	+, -, x, /	
		Righthand side	CH number		
		Scaling		/1000000, /1000, x1, x1000, x1000000	
		Operations span	Dec pt		x1, x10, x100, x1000, x10000
			Upper limit		Set numeric value.
		Lower limit		Set numeric value.	
	Select		Cur, Length, Area, Volume, Velocity, Accel, Freq, Mass, Energy, Pressure, Flow, Temp, Strain, Brightness, Concentration; Optional		
	Unit		The selections vary depending on the unit selected in the above. (Enter arbitrary text: Up to 8 characters)		
	Span settings	Upper limit		Set numeric value.	
		Lower limit		Set numeric value.	
	Set waveform color			0 to 31 for each of red, green, blue (RGB)	
	Line Thickness Setting			1 to 8 dots	
Trace			Off, On		

Setting		Selections available	
Misc.	[DC, RH]	Perform Auto Zero ADJ.	▶ Press right key to execute.
		Reset Auto Zero ADJ.	▶ Press right key to execute.
	[RMS]	RMS value operation cross value	Set numeric value.
		Reads the current voltage meas. value	▶ Press right key to execute.
		Cross value reset	▶ Press right key to execute.
	[RH]	Burnout check	▶ Press right key to execute.

<Logic/Pulse settings>

Setting		Selections available		
Logic/Pulse		Off, Logic, Pulse		
[Logic]	Filter		Off, On	
	Misc.	Annotation text string	Enter text. (Max. 31 characters)	
		Set waveform color	0 to 31 for each of red, green, blue (RGB)	
		Trace	Off, On	
	[Pulse]	Input		Off, Revolution counts, Counts, Inst.
		Filter		Off, On
		Slope		H, L
		EU	Function	Off, On
			Meas. Value	Set numeric value.
			EU value	Set numeric value.
			Select	Cur, Length, Area, Volume, Velocity, Accel, Freq, Mass, Energy, Pressure, Flow, Temp, Strain, Brightness, Concentration; Optional
			Unit	The selections vary depending on the unit selected in the above. (Enter arbitrary text: Up to 8 characters)
		Arbitrary unit	Enter text.	
		Misc.	Annotation text string	
	Span Set-tings			Set numeric value.
			Lower limit	Set numeric value.
	Set waveform color		0 to 31 for each of red, green, blue (RGB)	
	Line Thickness Setting		1 to 8 dots	
	Trace		Off, On	
Pulses per revolution	1 to 10000			

Analog settings

Settings the conditions for analog signals.

CHECKPOINT

When you use CH ALL to set input, range, filter and EU, all channels are set to the same values when input is the same. Range is set only for the same input channels. However, the range of a channel is not changed if EU (scaling) is set to On.

CH ALL - Misc. - Span Settings is set only for the same range channels.

(1)-1 Input

Select input conditions.

Selection item	Description
Off	Input signal measurement is disabled. No waveform or digital value is displayed.
DC	Used for measuring direct-current voltage.
RMS	Used to measure the RMS of AC voltage.
TEMP	Used for measuring temperature.
RH	Used for measuring humidity with the humidity sensor B-530. In this case, the voltage range will become 1 V, and the EU settings will not be available

* Enter DC-RMS as the effective value (RMS).

(1)-2 Range

Select the range to measure.

Input item	Description
DC	20, 50, 100, 200, 500 mV, 1, 2, 5, 10, 20, 50, 100, 200, 500, 1000 V, 1-5 V
RMS	10, 25, 50, 100, 250, 500 mVrms 1, 2.5, 5, 10, 25, 50, 100, 250, 500, 1000 Vrms
TEMP	TC-K, TC-J, TC-T, TC-R, TC-E, TC-B, TC-S, TC-N, TC-W
RH	100% fixed

Available SPAN Settings

< Voltage Ranges >

Range	Maximum SPAN	Minimum SPAN	Minimum Resolution
20mV	-22.000 to +22.000mV	0.200mV	0.001mV
50mV	-55.00 to +55.00mV	0.50mV	0.01mV
100mV	-110.00 to +110.00mV	1.00mV	0.01mV
200mV	-220.00 to +220.00mV	2.00mV	0.01mV
500mV	-550.0 to +550.0mV	5.0mV	0.1mV
1V	-1.1000 to +1.1000V	0.0100V	0.0001V
2V	-2.2000 to +2.2000V	0.0200V	0.0001V
5V	-5.500 to +5.500V	0.050V	0.001V
10V	-11.000 to +11.000V	0.100V	0.001V
20V	-22.000 to +22.000V	0.200V	0.001V
50V	-55.00 to +55.00V	0.50V	0.01V
100V	-110.00 to +110.00V	1.00V	0.01V
200V	-220.00 to +220.00V	2.00V	0.01V
500V	-550.0 to +550.0V	5.0V	0.1V
1000V	-1.1000k to +1.1000kV	0.0100kV	0.1V
1-5V	-5.500 to +5.500V	0.050V	0.001V

<Effective value (RMS) range>

Range	Maximum SPAN	Minimum SPAN	Minimum Resolution
10mVrms	-11.000 to +11.000mVrms	0.100mVrms	0.001mVrms
25mVrms	-27.500 to +27.500mVrms	0.250mVrms	0.002mVrms
50mVrms	-55.00 to +55.00mVrms	0.50mVrms	0.01mVrms
100mVrms	-110.00 to +110.00mVrms	1.00mVrms	0.01mVrms
250mVrms	-275.00 to +275.00mVrms	2.50mVrms	0.02mVrms
500mVrms	-550.0 to +550.0mVrms	5.0mVrms	0.1mVrms
1Vrms	-1.1000 to +1.1000Vrms	0.0100Vrms	0.0001Vrms
2.5Vrms	-2.7500 to +2.7500Vrms	0.0250Vrms	0.0002Vrms
5Vrms	-5.500 to +5.500Vrms	0.050Vrms	0.001Vrms
10Vrms	-11.000 to +11.000Vrms	0.100Vrms	0.001Vrms
25Vrms	-27.500 to +27.500Vrms	0.250Vrms	0.002Vrms
50Vrms	-55.00 to +55.00Vrms	0.50Vrms	0.01Vrms
100Vrms	-110.00 to +110.00Vrms	1.00Vrms	0.01Vrms
250Vrms	-275.00 to +275.00Vrms	2.50Vrms	0.02Vrms
500Vrms	-550.0 to +550.0Vrms	5.0Vrms	0.1Vrms
1000Vrms	-1.1000k to +1.1000kVrms	0.0100kVrms	0.1Vrms

< Temperature Ranges > : Celsius

Range	Maximum SPAN	Minimum SPAN (p-p)	Measurable Range	Minimum Resolution
K	-273.0 to +2000.0°C	10°C	-200 to +1370°C	0.1°C
J	-273.0 to +2000.0°C	10°C	-200 to +1100°C	
T	-273.0 to +2000.0°C	10°C	-200 to +400°C	
R	-273.0 to +2000.0°C	10°C	0 to +1600°C	
E	-273.0 to +2000.0°C	10°C	-200 to +800°C	
B	-273.0 to +2000.0°C	10°C	+400 to +1820°C	
S	-273.0 to +2000.0°C	10°C	0 to +1760°C	
N	-273.0 to +2000.0°C	10°C	-200 to +1300°C	
W	-273.0 to +2000.0°C	10°C	0 to +2000°C	

< Temperature Ranges > : Fahrenheit

Range	Maximum SPAN	Minimum SPAN (p-p)	Measurable Range	Minimum Resolution
K	-459.0 to +3000.0°F	10°F	-328 to +2498°F	0.18°F
J	-459.0 to +3000.0°F	10°F	-328 to +2012°F	
T	-459.0 to +3000.0°F	10°F	-328 to +752°F	
R	-459.0 to +3000.0°F	10°F	-32 to +2912°F	
E	-459.0 to +3000.0°F	10°F	-328 to +1472°F	
B	-459.0 to +3000.0°F	10°F	+7512 to +3000°F	
S	-459.0 to +3000.0°F	10°F	-32 to +3000°F	
N	-459.0 to +3000.0°F	10°F	-328 to +2372°F	
W	-459.0 to +3000.0°F	10°F	-32 to +3000°F	

< Humidity Range >

Range	Maximum SPAN	Minimum SPAN (p-p)	Minimum Resolution
	0.00 to +110.00%	0.10%	0.01%

(1)-3 Filter

Selects the range to be measured.

Selection item	Description
Off	Filter is not used.
Line	Cutoff frequency is 1.5 Hz.
5Hz	Cutoff frequency is 5 Hz.
50Hz	Cutoff frequency is 50 Hz.
500Hz	Cutoff frequency is 500 Hz.
5kHz	Cutoff frequency is 5 kHz.
50kHz	Cutoff frequency is 50 kHz.

(1)-4 EU (Scaling settings)

This is used to convert the measured signals to other units.

<When input is voltage and effective value (RMS)>



<When input is temperature>

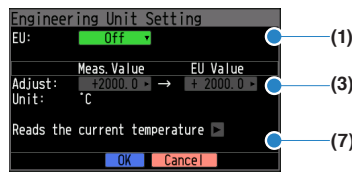

Setting	Description
(1) EU	Set the scaling function to ON or OFF.
(2) Dec pt	Set the decimal point position for an EU value.
(3) Meas. Value (Upper/Lower)	Set the upper and lower limits of values to be converted. * For temperature input, there is no distinction between upper and lower limits. See the setting examples shown below for details.
(4) EU Value (Upper/Lower)	Set the upper and lower limits of values to be converted. * For temperature input, there is no distinction between upper and lower limits. See the setting examples shown below for details.
(5) Select	Select a specific engineering unit classification. (The following are available.) Cur, Length, Area, Volume, Velocity, Accel, Freq, Mass, Energy, Pressure, Flow, Temp, Strain, Brightness, Concentration; Optional You can enter arbitrary units by selecting Arbitrary.
(6) Unit	Select a unit to be used after conversion. A unit displayed in this field belongs to the classification selected in "Select". To set a unit not displayed in this field, set arbitrary text in "Arbitrary unit." The setting selected in this field is displayed in "Arbitrary unit." (Number of characters that can be entered: Up to 8 characters)
(7) Reads the current temperature	Substitute the currently measured value into (3) Meas. Value and (4) EU Value. * The value is not substituted when burnout occurs or the scale is exceeded.

CHECKPOINT

- If a message window opens, follow the instruction in the message to change the setting value.
- The Scaling function performs calculation using a ratio of the Meas. Value and EU Value settings.
When the digital display shows “++++/----”, the converted value will not be processed by this device.
- The span may be changed depending on the Scaling settings.
- For temperature input, the offset setting for an input value is used.

Setting example: For voltage input

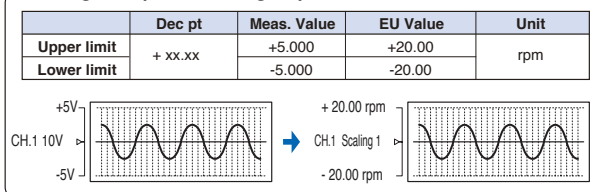

Setting example: For temperature input

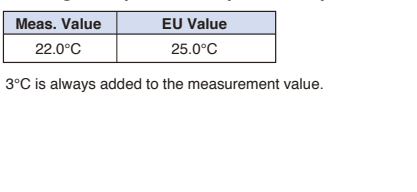

(1)-5 Other settings

< Voltage/Humidity >

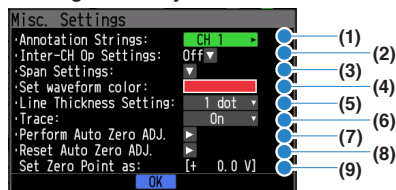

< Effective value (RMS) >

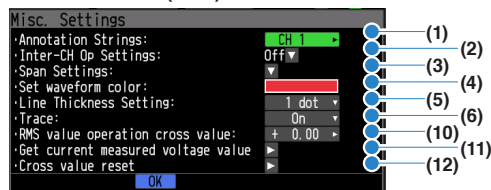

< Temperature >

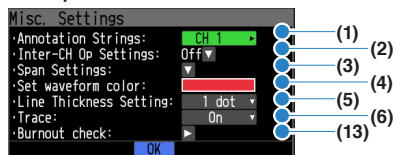

Setting object	Setting	Description
DC RMS TEMP RH	(1) Annotation Settings	Set the annotation (comment) displayed in the CH.
	(2) Inter-CH Op Settings	Set rule for calculation between channels. Four arithmetic operations (+, -, x, ÷) can be set as calculation between channels.
	(3) Span Settings	Set the upper limit of the span displayed in the Y-T waveform.
	(4) Set waveform color	Set the display color of each CH. 0 to 31 for each of red, green, blue (RGB)
	(5) Line Thickness Setting	Set the line thickness (1 to 8 dots).
	(6) Trace	Set the waveform display to On or Off.
DC RH	(7) Perform Auto Zero ADJ.	The current input voltage (RH) is calculated as a zero point voltage value (zero point RH value).
	(8) Reset Auto Zero ADJ.	Reset the zero point voltage value (zero point RH value).
	(9) Set Zero Point as	The zero point voltage value (zero point RH value) is displayed.
RMS	(10) RMS value operation cross value	Set the voltage where is the ± cross value for performing the RMS operation.
	(11) Get current measured voltage value	The RMS operation cross value of (10) is calculated automatically from the current input waveform.
	(12) Cross value reset	Reset the RMS operation cross value. (Set to 0V.)
RH	(13) Burnout check	Check the disconnection of the thermocouple.

Calculation between CHs settings

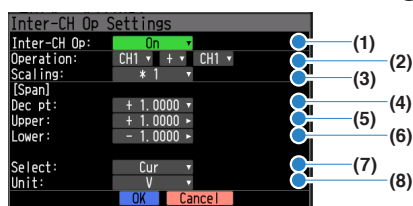

Setting	Description
(1) Inter-CH Op	Off, On If this setting is ON, the channel has a calculation mark in the digital display, etc. Calculation mark
(2) Operation	Set the calculation formula. Set right-hand side CH, left-hand side CH and operator. The result of calculation is reflected in the set CH. Right-hand side CH (Operator) Left-hand side CH Right-hand side CH, Left-hand side CH: CH1 to CH4 Operator: +, -, x, / The values assigned to the right-hand side CH and left-hand side CH are the measured values before the calculation. You cannot change the value after calculation. CH-X (Function) CH-Y

Setting	Description								
(3) Scaling	<p>Set the scaling factor for a calculation result. /1000000, /1000, x1, x1000, x1000000</p> <p><Example></p> <table border="1"> <tr> <td>In the case of calculation result = 0.001</td> <td>In the case of calculation result = 1000</td> </tr> <tr> <td>Calculation result x1 = 0.001</td> <td>Calculation result x1 = 1000</td> </tr> <tr> <td>Calculation result x1000 = 1</td> <td>Calculation result / 1000 = 1</td> </tr> <tr> <td>Calculation result x1000000 = 1000</td> <td>Calculation result / 1000000 = 0.001</td> </tr> </table>	In the case of calculation result = 0.001	In the case of calculation result = 1000	Calculation result x1 = 0.001	Calculation result x1 = 1000	Calculation result x1000 = 1	Calculation result / 1000 = 1	Calculation result x1000000 = 1000	Calculation result / 1000000 = 0.001
In the case of calculation result = 0.001	In the case of calculation result = 1000								
Calculation result x1 = 0.001	Calculation result x1 = 1000								
Calculation result x1000 = 1	Calculation result / 1000 = 1								
Calculation result x1000000 = 1000	Calculation result / 1000000 = 0.001								
Span									
(4) Dec pt	Set the upper and lower limits of values to be converted. * For temperature input, there is no distinction between upper and lower limits. See the setting examples shown below for details.								
(5) Upper (6) Lower	Set the upper limit and lower limit of the span displayed in the Y-T waveform. This setting is for calculation only. When Operation is On, this span is used instead of the span that set in [AMP] - [Misc.] - [Span setting].								
(7) Select	Select a specific engineering unit classification. (The following are available.) Cur, Length, Area, Volume, Velocity, Accel, Freq, Mass, Energy, Pressure, Flow, Temp, Strain, Brightness, Concentration; Optional								
(8) Unit	Select a unit to be used after conversion. A unit displayed in this field belongs to the classification selected in "Select". To set a unit not displayed in this field, set arbitrary text in "Arbitrary unit." The setting selected in this field is displayed in "Arbitrary unit". (Number of characters that can be entered: Up to 8characters)								

CHECKPOINT

When EU is set to OFF, m (milli) or k (kilo), etc. of engineering unit is taken into account in the calculation. For example, 100 mV is treated as 0.1.

When EU is set to ON, the engineering unit set in the EU character string is not taken into account. The numerical value of the EU calculation result is the calculated numerical value.

Span settings

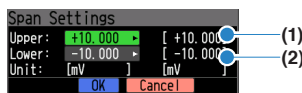

Setting	Description
(1) Upper	Set the upper limit of the span displayed in the Y-T waveform. When EU setting is On, set the EU-converted value. (Numbers in [] are numbers before EU conversion.)
(2) Lower	Set the lower limit of the span displayed in the Y-T waveform. When EU setting is On, set the EU-converted value. (Numbers in [] are numbers before EU conversion.)

Set waveform color

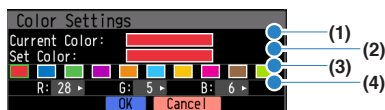

Setting	Description
(1) Current Color	The currently set color is displayed.
(2) Set Color	The color to set from now is displayed.
(3) Preset Color	Available colors to choose from.
(4) R (red), G (green), B (blue)	Set to 0 to 31 for each of red, green, blue (RGB) Additional selection of colors to choose from.

Zero adjustment function

Zero adjustment is a function to force cancel the offset of measured value with offset.

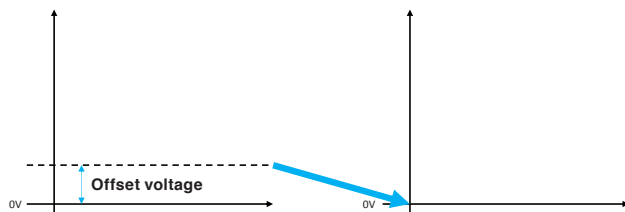

For example, when the offset voltage is +1V, and if +1V is actually input, the device measures +1V as 0V.



Setting	Description
(1) Perform Auto Zero ADJ.	The current input voltage (RH) is set to the zero point voltage value (zero point RH value) as a offset voltage value (offset RH value).
(2) Reset Auto Zero ADJ.	The zero point voltage value (zero point RH value) is reset.
(3) Set Zero Point as	The zero point voltage value (zero point RH value) is displayed. When the voltage value (RH value) displayed in this field is input, it is measured as 0 V (0%).

Effective value (RMS) and operation cross value

The effective value (RMS) is obtained by operating the measured value.

To calculate the effective value (RMS), it is necessary to calculate one cycle of the input signal.

The voltage value used for detecting one cycle of the input signal is called the cross voltage.

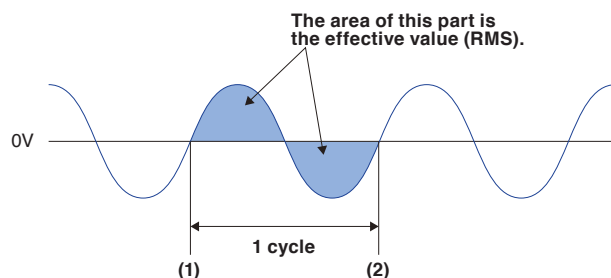

In the case of the above example, the effective value (RMS) can be obtained without specifying this cross value.

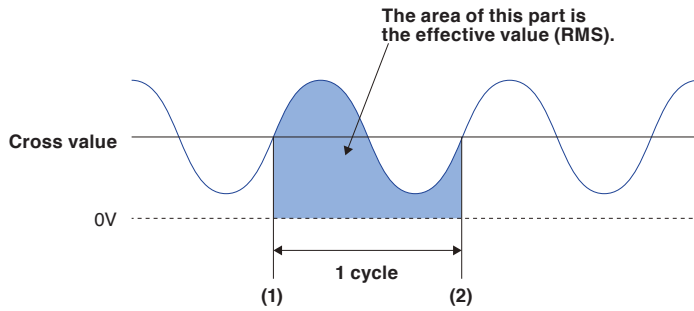

In the above example, the effective value (RMS) can be obtained by specifying this cross value. To obtain the cross value, specify the voltage crossing the waveform. If the waveform fluctuates up and down, check the waveform and set the cross value. The operation method (of this device) is shown below.

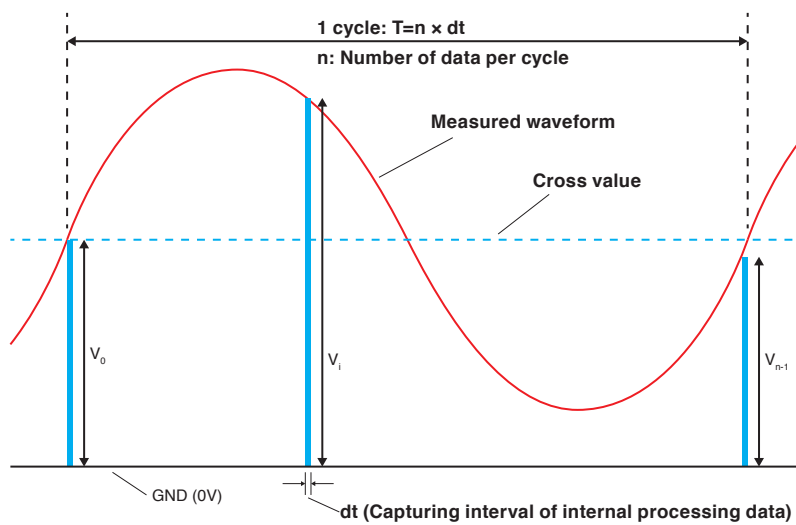

$$\text{Effective value (RMS)} = \sqrt{\frac{1}{n \times dt} \sum_{i=0}^{n-1} V_i^2 \cdot dt} = \sqrt{\frac{1}{n} \sum_{i=0}^{n-1} V_i^2}$$

By specifying the cross voltage value, you can calculate the effective value (RMS).



Setting	Description
(1) RMS value operation cross value	Set the voltage which is the ± cross value for performing the RMS operation.
(2) Get current measured voltage value	The RMS operation cross value of (1) is calculated automatically from the current input waveform.
(3) Cross value reset	Reset the RMS operation cross value. (Set to 0V.)

When reading from the current measured voltage value, calculate after the actual input is entered.

Burnout check

Burnout refers to a state where the thermocouple is disconnected.

Check burnout of CH that is set to temperature.

Since the device cannot detect burnout and measure at the same time, check whether or not burnout has occurred when measurement is not performed.

Please be aware that the measured value is not accurate when burnout takes place.

Logic and Pulse settings

For settings related to digital input.

< Pulse setting >

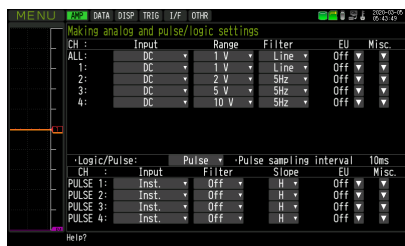

< Logic setting >

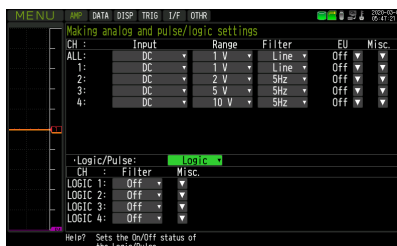

(1)-6 Logic/Pulse

To select the processing method for digital input.

Selection item	Description
Off	Digital input measurement is disabled.
Logic	Digital input is processed as logic signals.
Pulse	Digital input is processed as pulse signals.

* When pulse input is selected, the sampling interval for pulse is displayed. For details of sampling intervals for pulse, refer to "3.5 Setting Menus" - "(2) DATA setting" - "Sampling interval".

(1)-7 Input

To set the pulse measurement mode. This setting is available only if Pulse is selected in (1)-6.

Selection item	Description
Off	Pulse input measurement is disabled.
Revol.	The number of pulses per sample interval is counted and converted to the number of revolutions per minute.
Counts	Captures the cumulative number of pulses for each sampling interval from the start of measurement.
Inst.	Captures the number of pulses for each sampling interval.

(1)-8 Filter

To set the filter for input.

Selection item	Description
Off	Disables hardware filter.
On	Enables hardware filter. It is effective in a noisy environment. The filter is approximately 30 Hz (-3 dB).

(1)-9 Slope

To set the slope (direction) to count the number of pulses. This setting is available only if Pulse is selected in (1)-6.

Selection item	Description
H	Counts the rising edges of pulses.
L	Counts the falling edges of pulses.

(1)-10 EU (scaling settings)

The measured signal is converted with the engineering unit. This item can be set only when pulse is selected in (1)-6.

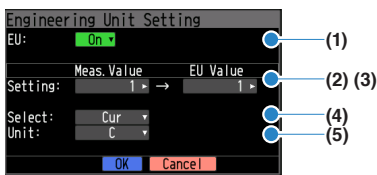

Setting	Description
(1) EU	Set the scaling function to ON or OFF.
(2) Meas. Value	Set a value to be converted.
(3) EU Value	Set an output value after conversion.
(4) Select	Select a specific engineering unit classification. (The following are available.) Cur, Length, Area, Volume, Velocity, Accel, Freq, Mass, Energy, Pressure, Flow, Temp, Strain, Brightness, Concentration; Optional You can enter arbitrary units by selecting Arbitrary.
(5) Unit	Select a unit to be used after conversion. A unit displayed in this field belongs to the classification selected in "Select". To set a unit not displayed in this field, set arbitrary text in "Arbitrary unit". The setting selected in this field is displayed in "Arbitrary unit". (Number of characters that can be entered: Up to 8characters)

CHECKPOINT

- If a message window opens, follow the instruction in the message to change the setting value.
- The Scaling function performs calculation using a ratio of the Meas. Value and EU Output Value settings.
- The digital display shows “++++/----” when the converted value cannot be processed by the device.
- The span may vary depending on the scaling settings.

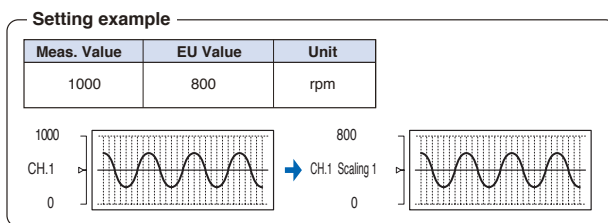

(1)-11 Misc.

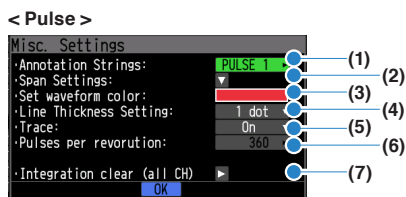

Setting	Description
(1) Annotation Settings	Set the annotation (comment) displayed in the CH.
(2) Span Settings	Set the upper and lower limits of the span displayed in the Y-T waveform. (Pulse only) * When Pulse input is Integration, it is in the auto span state and can not be set.
(3) Set waveform color	Set the display color of each CH. 0 to 31 for each of red, green, blue (RGB)
(4) Line Thickness Setting	Set the line thickness (1 to 8 dots). (Pulse only)
(5) Trace	Set the waveform display to On or Off.
(6) Pulses per revolution	1 to 10000 When the pulse input is set to Pulses per revolution, set the number of pulses per revolution. The number of revolutions per minute (RPM) is calculated, assuming that the number of pulses set here is one revolution. When 100 is set, and then 100 pulses are input, it is 1 revolution when 100 pulses have been input. <Calculation formula> Number of revolutions (RPM) = Number of pulses ÷ Number of pulses per revolution x 60 (1 minute) <Example> Number of pulses per revolution: 100 (1 rotation is judged when 100 pulses have been input.) Pulse input: 1000 Hz (1000 pulses per sec.) Number of revolutions: 600 RPM (600 RPM per min.)
(7) Integration clear (all CH)	Clear (set to 0) the integrated value of the pulse CH that is set to the Integration input. (Pulse only)

(2) DATA settings

Set items related to data capturing.

< When the capturing destination is internal RAM >



< When the capturing destination is internal memory, SD card, USB memory >

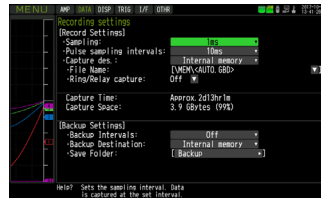

Setting		Selections available
Sampling		Set the main sampling. (1, 2, 5, 10, 20, 50, 100, 200, 500 μ s) 1, 2, 5, 10, 20, 50, 100, 200, 500 ms 1, 2, 5, 10, 20, 30 s, 1 min, External * The setting range varies depending on the recording destination. You can select the values in parentheses only when the internal RAM is set.
Pulse sampling intervals		Set the Pulse sampling intervals. (10, 20, 50, 100, 200, 500 μ s) 1, 2, 5, 10, 20, 50, 100, 200, 500 ms 1, 2, 5, 10, 20, 30 s 1, 2, 5, 10, 20, 30 min, 1 hour * Setting range varies depending on the capturing destination. You can select the values in parentheses only when the internal RAM is set.
Capture des.		Set the data capturing destination. Internal RAM, internal memory, SD card, USB memory
[Internal memory]	Memory block division	Set the memory division. No division, 2-division, 4-division, 8-division
	Block status	The memory block usage state is displayed.
	Overwrite mode	Set the overwrite mode of the data in the internal memory. Off, On
	Internal RAM clear	The data captured to the internal RAM is erased.
	Data pts.	Set the number of data to be captured to the internal RAM. 10 to 4000000 * The setting range varies depending on memory block division.
	Ring recording	Set the ring capturing. Off, On
	Auto Save	Set the auto save. Off, On
	File Name	Set the auto saving destination. * Refer to the following "Capture des.: FileName".
[Internal Memory] [SD card] [USB memory]	Capture des.: FileName	Set the saving destination of captured data. * Refer to the following "Capture des.: FileName".
	Capture des.: Ring/Relay capture	Set the ring capture/relay capture. Off, Ring, Relay
	Backup Intervals	Set the backup interval. Off, 1 hour, 2 hours, 6 hours, 12 hours, 24 hours, specified time
	Backup Destination	Set the backup destination. Internal memory, SD card, USB memory
	Save Folder	Set the saving folder and the path of the backup destination.

Capturing destination file name

Setting		Selections available
File Type		Set the saving format of data file. GBD, CSV
Name Type		Set the file naming method. Automatic, Arbitrary, Sequential number
[Auto]	Folder	Set the folder of the auto saving destination.
	Prefix	Set the prefix character string of file name.
[Arbitrary] [Sequential number]	Folder	Set the data file name. The folder for saving the file is displayed in the Folder.
	File	

Setting	Selections available
CSV decimal point	Set the decimal point character of the CSV file. Period (.), Comma (,)
CSV delimiter	Set the delimiter of the CSV file. Comma (,), Tab, Semicolon (;)

(2)-1 Sampling interval (main sampling interval)

Set the interval for capturing data.

Setting	Description
Internal RAM	1, 2, 5, 10, 20, 50, 100, 200, 500 μ s, 1, 2, 5, 10, 20, 50, 100, 200, 500ms, 1, 2, 5, 10, 20, 30s, 1min, External
Internal memory/SD card/USB memory	(1, 2, 5,) 10, 20, 50, 100, 200, 500ms, 1, 2, 5, 10, 20, 30s, 1min, External * When the CSV file format is set after ring and relay function is enabled, the sampling in parentheses () cannot be selected.

CAUTION

- When the internal RAM is selected and the external sampling is set, the data is read in 1 μ s as internal processing, an external pulse is used, and the next internal processing data is write to the memory. Therefore, the capturing interval is at maximum 1 μ s and the maximum input error is 1 μ s.

Please use the external sampling function within the range where this error is not a problem.

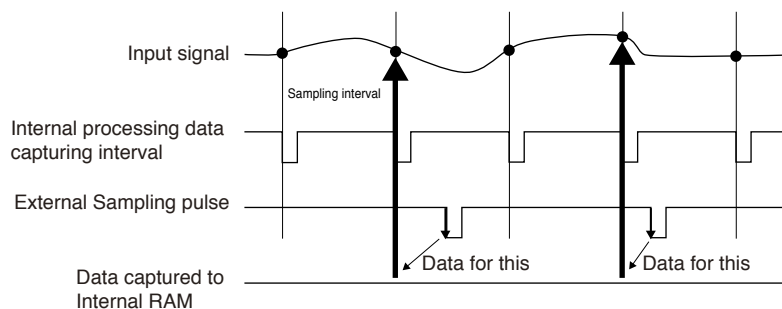

CHECKPOINT

- When the external sampling function is set to On and then internal memory/SD card/USB memory is selected, the internal processing interval is 1 ms. The capturing interval is also 1 ms maximum.
- If the external sampling function is ON, the external input cannot be selected for the trigger setting. If the external input has already been set, the trigger will be set to Off.

(2)-2 Pulse sampling interval

Set the interval for capturing pulse data.

The pulse sampling interval can be set under the following conditions.

Condition 1: Main sampling and interval are the same or larger.

Condition 2: Sampling interval which is n times main sampling.

When changing the main sampling interval, if it does not meet the above conditions, the sampling interval for pulse is also initialized in the same way as the main sampling interval.

Main Sampling Interval	Pulse sampling Interva																											
	μ s						ms						s						min						hour			
	10	20	50	100	200	500	1	2	5	10	20	50	100	200	500	1	2	5	10	20	30	1	2	5	10	20	30	1
1	○	○	○	○	○	○	○	○	○	○	○	○	○	○	○	○	○	○	○	○	○	○	○	○	○	○	○	○
2	○	○	○	○	○	○	○	○	○	○	○	○	○	○	○	○	○	○	○	○	○	○	○	○	○	○	○	○
5	○	○	○	○	○	○	○	○	○	○	○	○	○	○	○	○	○	○	○	○	○	○	○	○	○	○	○	○
10	○	○	○	○	○	○	○	○	○	○	○	○	○	○	○	○	○	○	○	○	○	○	○	○	○	○	○	○
20	×	○	×	○	○	○	○	○	○	○	○	○	○	○	○	○	○	○	○	○	○	○	○	○	○	○	○	○
50	×	×	○	○	○	○	○	○	○	○	○	○	○	○	○	○	○	○	○	○	○	○	○	○	○	○	○	○
100	×	×	×	○	○	○	○	○	○	○	○	○	○	○	○	○	○	○	○	○	○	○	○	○	○	○	○	○
200	×	×	×	×	○	×	○	○	○	○	○	○	○	○	○	○	○	○	○	○	○	○	○	○	○	○	○	○
500	×	×	×	×	×	○	○	○	○	○	○	○	○	○	○	○	○	○	○	○	○	○	○	○	○	○	○	○
1	×	×	×	×	×	×	○	○	○	○	○	○	○	○	○	○	○	○	○	○	○	○	○	○	○	○	○	○
2	×	×	×	×	×	×	○	○	○	○	○	○	○	○	○	○	○	○	○	○	○	○	○	○	○	○	○	○
5	×	×	×	×	×	×	×	○	○	○	○	○	○	○	○	○	○	○	○	○	○	○	○	○	○	○	○	○
10	×	×	×	×	×	×	×	×	○	○	○	○	○	○	○	○	○	○	○	○	○	○	○	○	○	○	○	○
20	×	×	×	×	×	×	×	×	×	○	×	○	○	○	○	○	○	○	○	○	○	○	○	○	○	○	○	○
50	×	×	×	×	×	×	×	×	×	×	○	○	○	○	○	○	○	○	○	○	○	○	○	○	○	○	○	○
100	×	×	×	×	×	×	×	×	×	×	×	○	○	○	○	○	○	○	○	○	○	○	○	○	○	○	○	○
200	×	×	×	×	×	×	×	×	×	×	×	×	○	×	○	○	○	○	○	○	○	○	○	○	○	○	○	○
500	×	×	×	×	×	×	×	×	×	×	×	×	×	○	○	○	○	○	○	○	○	○	○	○	○	○	○	○
1	×	×	×	×	×	×	×	×	×	×	×	×	×	×	○	○	○	○	○	○	○	○	○	○	○	○	○	○
2	×	×	×	×	×	×	×	×	×	×	×	×	×	×	×	○	×	○	○	○	○	○	○	○	○	○	○	○
5	×	×	×	×	×	×	×	×	×	×	×	×	×	×	×	×	×	○	○	○	○	○	○	○	○	○	○	○
10	×	×	×	×	×	×	×	×	×	×	×	×	×	×	×	×	×	×	○	○	○	○	○	○	○	○	○	○
20	×	×	×	×	×	×	×	×	×	×	×	×	×	×	×	×	×	×	×	○	×	○	○	○	○	○	○	○
30	×	×	×	×	×	×	×	×	×	×	×	×	×	×	×	×	×	×	×	×	○	○	○	○	○	○	○	○
1 min	×	×	×	×	×	×	×	×	×	×	×	×	×	×	×	×	×	×	×	×	×	○	○	○	○	○	○	○

(2)-3 Capturing destination

Set the capturing destination of the measured data.

Setting	Description
Internal RAM	<p>The measured data is captured to the internal RAM. The data is lost when you turn off the power. When Overwrite is set to On, the data is overwritten if the next capturing is performed. Confirm the waveform, if it is OK, press the [FILE] key to save the data. (Refer to "3.5 Setting Menus" - "7. File menu".) Additionally, When Auto Save is set to On, the data is saved automatically.</p> <p>TIP</p> <p>You can use all the sampling intervals. Select and capture at speed faster than 500 μs. Also, when the waveform of the captured data is checked to save only the necessary data, the memory can be saved for that instance.</p>
Internal memory/ SD card/ USB memory	<p>The measured data is captured to the internal memory/SD card/USB memory. The captured data is saved even when the power is turned off. This cannot be selected when the sampling interval is 1 to 500 μs. In this case, set the sampling interval to a value slower than 1 ms.</p> <p>TIP</p> <p>You can also use large capacity SD card (*1)/USB memory (*2) (*3). When the capacity of the internal memory is insufficient (up to 4GB can be saved in one capturing) and you want to capture for more intervals or you measure for a longer period.</p> <p>(*1) SD card and SDHC card are available. SDXC card is not available. (*2) FAT32/FAT16 format is available. NTFS, exFAT format is not available. (*3) Please note that you cannot use the USB memory with security function such as fingerprint authentication and the USB memory without shell (metal part) in the connector part.</p> <p>For check the latest information and support information, please check with the following URL. http://www.graphtec.com/</p>

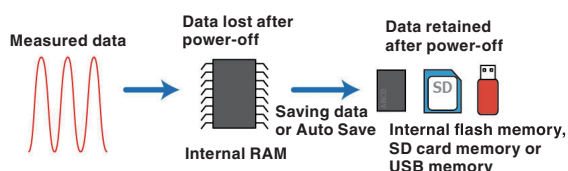

(2)-4 Memory block division

Internal RAM can be divided into blocks. Multiple data can be captured to divided blocks.

This can be set only when the capturing destination is set to the Internal RAM.

The number of divided blocks and the maximum number of data points when divided is as shown in the table below.

Number of divisions	Maximum recording points
No division	4000000 points
2-division	2000000 points
4-division	1000000 points
8-division	500000 points

CHECKPOINT

When changing the number of divided blocks in the internal RAM, all saved data in the internal RAM is erased.

(2)-5 Overwrite mode

Set whether to overwrite the data in the internal RAM or not.

This can be set only when the capturing destination is set to internal RAM.

If Overwrite is set to On, existing recorded data is erased and overwritten.

Using a block usage, the difference with On and Off from the overwrite mode is described below.

For details on the status display of Internal RAM, refer to "3.1 Window names and functions" - "13. 13. Internal RAM information".

< Overwrite mode Off >



All eight blocks have not been recorded yet. All blocks are black.
This is recorded from the first block (the block with yellow line scheduled to be captured next time).



First to fourth blocks have been recorded.
If the overwrite mode is set to Off, they is not rerecorded.
The fifth block is being recorded now (The yellow line recording is displayed.).



All eight blocks have been recorded. All blocks turn green.
Recording operation cannot be started in this state.
Please clear the Internal RAM before starting recording.

(2)-6 Internal RAM clear

Erase data saved in internal RAM.

This can be set only when the recording destination is set to internal RAM.

Please be aware that erased data cannot be restored.

Back up the necessary data in the internal memory/SD card/USB memory before erasing.

(2)-7 Capturing points

Set the number of data points to be captured to the internal RAM. This can be set only when the capturing destination is set to internal RAM.

To set, refer to the capturable time display.

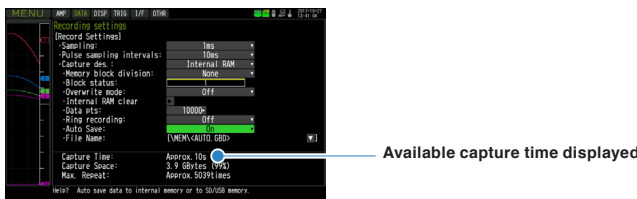

The maximum settable number of capturing points depends on the number of blocks divided in the internal RAM.

Setting	Description
No division	4000000 points
2-division	2000000 points
4-division	1000000 points
8-division	500000 points

CHECKPOINT

Capturing capacity and repeatable number displays are not displayed when the Ring is set. When Auto Save is set to On at the time of ring setting, it is displayed as information of auto saving destination. (Repeatable number of times = Number of times this device can do Auto Save)

(2)-8 Ring capturing (internal RAM)

Set ring capture for internal RAM.

This can be set only when the recording destination is set to internal RAM.

Ring capture is a function to continue data capture even if the data points exceed the number of data points set using the internal RAM as a ring buffer. If number of captured points exceed set data points, the oldest data is erased in order and the as the new data takes over.

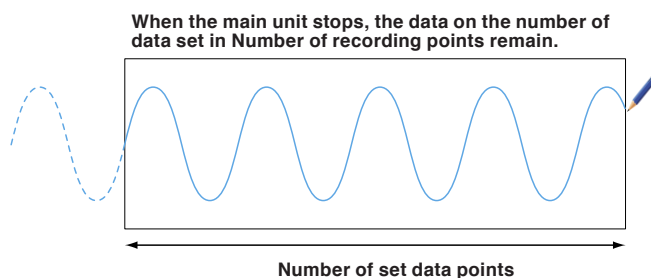

(2)-9 Auto save

Set whether to automatically save the data captured to the internal RAM. This can be set only when the internal RAM is selected as the recording destination.

Setting	Description
Off	Auto save is not performed. Data captured to the internal RAM is lost if you turn off the power or start the next recording. To save the recorded data, you need to save it by pressing [FILE] key.
On	Auto save is performed. Data captured to the internal RAM is saved in the internal memory/SD card/USB memory.  <p>If you set the faster sampling interval or the number of data points is increased, the Auto Save may not be completed even if the recording to the internal RAM is completed. In that case, you cannot perform the next recording with the [START/STOP] key until the Auto Save is completed. To stop automatic saving in the middle of the recording, select the "Auto Save stop" with the dialog button when the dialog is displayed, select "Auto Save stop" from the file menu or the function key. When execute Auto Save stop, the data up to that point is saved.</p>

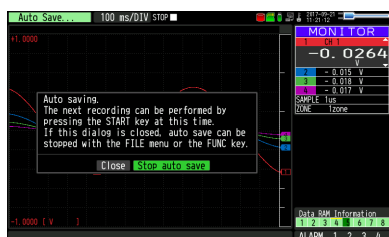

Dialog display

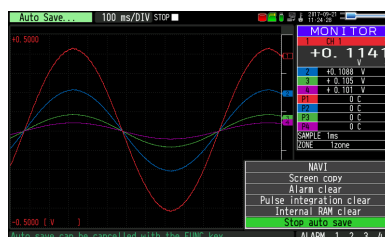

Function key

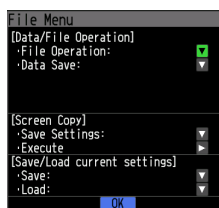

File menu

(2)-10 Recording destination file name (auto save)

Set the saving destination/file name when executing auto save.

This item can be set only when the recording destination is set to internal RAM and auto save is set to On.

For details of the contents, refer to (2) -11.

(2)-11 Recording destination file name (file capture)

Set the file name and folder name of the recording destination when capturing data.

< When the automatic naming method is used >

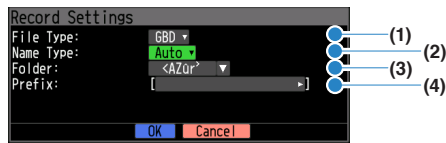

< When any file name and serial number is used for naming method >

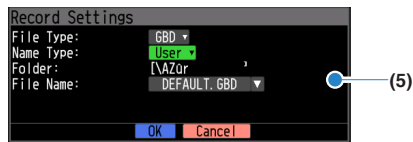

< When CSV file is used as file format >



Setting	Description
(1) File Type	Set the file format of data. GBD: The data file is created in our own binary format. * Data cannot be changed. CSV: The data file is created in text format.
(2) Name Type	Set the naming method for the data file. Auto: File name is created automatically Example) 20170728-123456.GBD Numbers: Date and time when the file is created * The above example shows July 28, 2017 12:34:56 Arbitrary: Captured data is saved to the file with the file name you entered. Serial number: Recorded data is saved to the file with the file name you entered and the serial number. Example) When the file name is set to "TEST" 1st time: TEST_SER1.GBD 2nd time: TEST_SER2.GBD 3rd time: TEST_SER3.GBD * If the same file name already exists, "_CP*" is added to the end of the file name to avoid any overwrite. The part of * is a number. Example) TEST_CP1.GBD
(3) Folder	Set the folder of saving destination when Auto is selected as the naming method.
(4) Prefix	Set the prefix character string of the file name. When a prefix character string is set, the prefix character string set before the automatically created file name (date/time/time file name) is added. Example) When "PRIFIX" is set as prefix character, The file name is "PRIFIX_20170728-123456.GBD".
(5) File	Set the saving file name when Arbitrary and Serial number is selected in naming method. The folder for saving the file is displayed in the Folder.
(6) CSV decimal point	Set the decimal point character of the CSV file. Period (.), Comma (,)
(7) CSV delimiter	Set the delimiter of the CSV file. Comma (,), Tab, Semicolon (;)

CAUTION

The file should be saved in the folder you created. When the data files continue to save in the root folder, the file may be not saved regardless of the remaining memory capacity due to the limitations of the file system.

CHECKPOINT

Changing the sampling interval, recording destination, number of measuring channels (number of channels for which the input is not Off), etc. will change the Capture Space and Capture Time on the screen display.

If you find that the measurement time exceeds the Capture Time, take one of the following measures:

- Change the sampling interval.
- Change the capturing destination SD card / USB memory to SD card / USB memory with more free space.



Capture Space : Displays the amount of memory space available for data capture.

Capture Time : Displays the time that can be captured

The Capture Time more than 366 days is displayed as 366 days over

CHECKPOINT

When inter-CH operation has been set and the data is saved in CSV file format, inter-CH operation data is saved in a column dedicated to inter-CH operation.

(2)-12 Ring/Relay capture settings

• Ring Capture Function

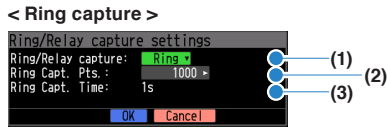

Setting	Description
(1) Ring/Relay capture	Set the capturing function. off: Capturing function is not used. Ring: Ring capture is performed. (For details, refer to the figure below.) Relay: Data is recorded consecutively for each file of up to 4GB without skipping any data. When the ring and relay functions are enabled, the sampling interval is from 10 ms when the CSV file format is set.
(2) Ring Capt. Pts.	When the ring capturing function is used, specify the number of data points of one file. (For details, refer to the figure below.) Please set the number of ring capturing points to meet the following conditions • Time to save one file in the ring status GBD capturing time: 15 seconds or more CSV capturing time: 30 seconds or more • One file capacity is 1/3 (one third) or less of the free space of the disk
(3) Ring Capt. Time	When the ring capturing function is On, the measurement time that can be captured with one file is displayed.

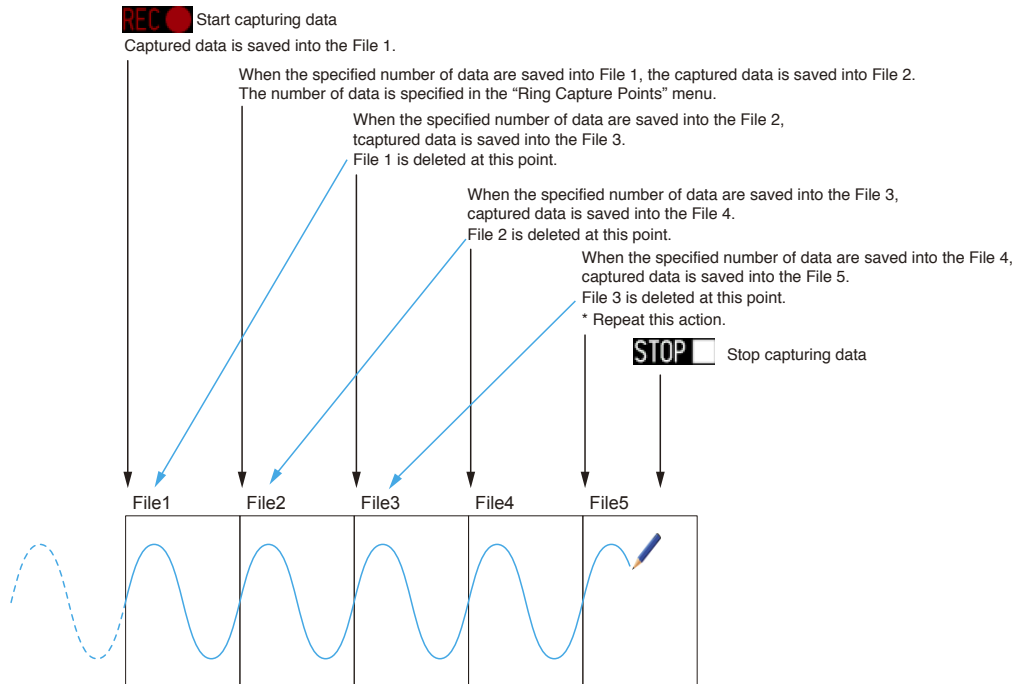

When recording is stopped at the STOP point in the above, File 4 and File 5 remains in the memory. These files are consolidated into one file. Ring capturing completes after combing the files.

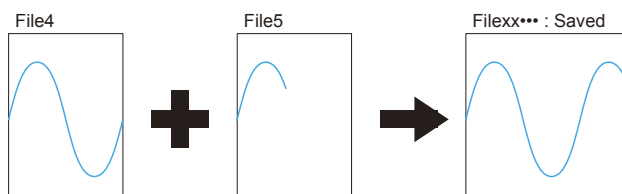

CHECKPOINT

Twice the number of Ring Capture Points can be created.

• Relay Capture Function

< Relay capture >

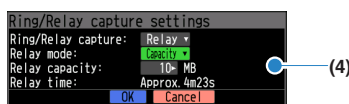

Setting	Description
(1) Ring/Relay capture	Set the capturing function. off: Capturing function is not used. Ring: Ring capture is performed. (For details, refer to the figure below.) Relay: Data is captured consecutively for each file of up to 4GB continuously. When the ring and relay functions are enabled, available sampling interval starts from 10 ms when the CSV file format is set.
(2) Relay mode	Set the mode for performing the relay processing. Time: After the set time has elapsed, the relay processing is performed. Capacity: When the file has reached the set file size, relay processing is performed.
(3) Relay time	Set the relay time when relay mode is set to "Time". 0 hour 1 minute to 24 hours 00 minutes * If the file size reaches 4GB before the set time elapses, the relay processing is performed even before the time elapses.
(4) Relay capacity	Set the file size when relay mode is set to "Capacity". 10MB to 4000MB * Estimated time for capturing with the set file size is displayed as "Relay time".

The recorded data is continuously captured by files separated in the set relay unit without losing data.
(The maximum capacity for a single file is 4GB.)

(2)-13 Backup setting

This device has a function to periodically back up recorded data.
(Refer to the figure below.)

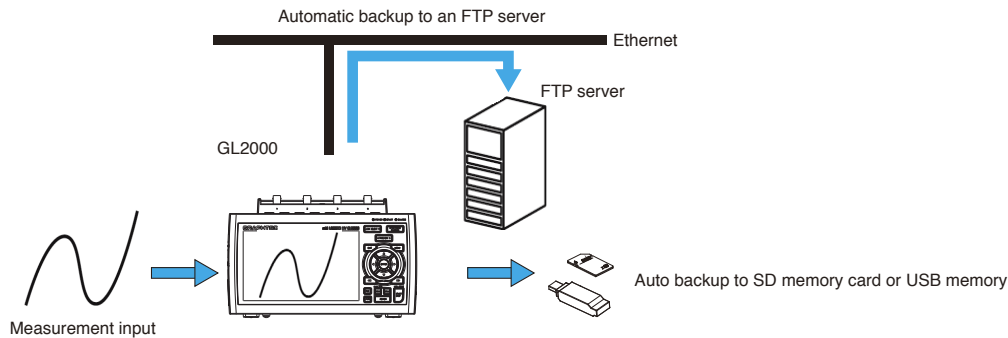

Setting	Description
(1) Backup intervals	Set the interval to back up the captured data. Off, 1, 2, 6, 12, 24 hours ;specified time
(2) Backup Destination	Set the backup destination of the captured data. Internal memory : The data is backed up to the internal memory of the device. SD card : The data is backed up to the SD card. USB memory : The data is backed up to the USB memory. FTP : Backs up data to an FTP server on the network. * Capturing destination and backup destination cannot be the same. * When SD card or USB memory is selected as backup destination, SD card and USB memory can be replaced. For details, refer to "3.5 Setting Menus" - "7. File menu". *The FTP server settings must be made using the Interface settings. (Refer to "FTP/WEB server settings".)
(3) Save folder	Set the folder to save the backup file. * This must be a folder on the Internal memory,SD card,USB memory or an FTP server. Example) \GRAPHTEC\20171001

CHECKPOINT

If ring capture is On, the backup function is not available.

When set to the CSV file format, the sampling interval is from 10 ms.

To replace the backup destination media, be sure to execute the Remove/Replace in the File menu before replacing.

If the sampling time is faster because the number of effective CHs is large, or the backup interval is longer, the size of the data to be backed up increases, so it may take time to finish writing at the time of capturing stop.

When saving to an FTP server, backup may fail depending on the communication environment and transfer speed.

(3) DISP settings

Set the screen display settings.

(3)-1 Y-T/Y-T (All waveforms) display

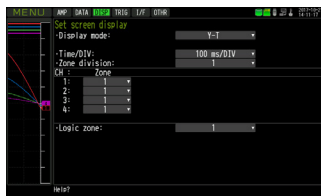
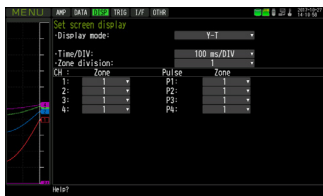

Setting	Description
Display mode	Set the display mode of the screen. Y-T, Y-T (All waveforms), Logging, XY
Time/DIV	Set the Time/DIV. Range depends on the sampling interval.
Zone division	Set the number of zone divisions. 1, 2, 4, 8
Zone	Set the zone allocation for analog CH and pulse CH. 1 to 8
Logic zone	Set the display position of the logic CH. 1 to 10

Display mode

Select the screen display mode.

Setting	Description
Y-T	Set to Y-T waveform + Digital display.
Y-T (All waveforms)	Set to All the waveforms on Y-T waveform display.
Logging	Set to Logging display/Real time statistical calculation display.
XY	Set to XY waveform display.

The contents in the DISP menu depend on each display mode.

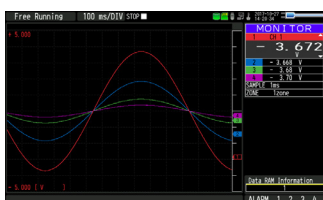

Y-T waveform + Digital display

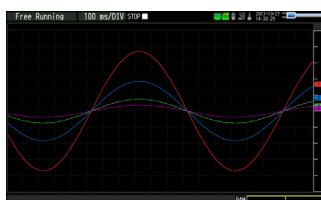

Y-T All waveforms display

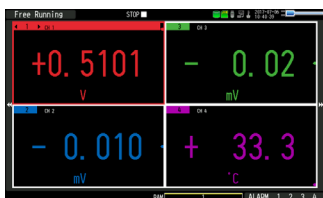

Logging display



Real time statistical calculation display

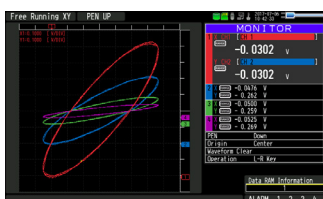

XY waveform display

Time/DIV

This is a function to enlarge or shrink the horizontal axis (T) of the waveform of Y-T graph. When setting this, set the time for one grid of graph. The shorter the set time interval. the larger the horizontal axis (T).

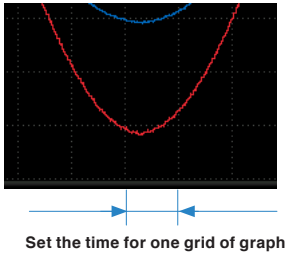

The range of the Time/DIV value that can set depends on the sampling interval setting.

Please refer to the table below.

Sampling Interval	Time/DIV																										
	us						ms						s						min								
	10	20	50	100	200	500	1	2	5	10	20	50	100	200	500	1	2	5	10	20	30	1	2	5	10	20	30
1us	●	●	●	●	●	●	●	●	●	○	○	○	○	×	×	×	×	×	×	×	×	×	×	×	×	×	
2us	×	●	●	●	●	●	●	●	●	○	○	○	○	○	×	×	×	×	×	×	×	×	×	×	×	×	
5us	×	×	●	●	●	●	●	●	○	○	○	○	○	○	×	×	×	×	×	×	×	×	×	×	×	×	
10us	×	×	×	●	●	●	●	●	○	○	○	○	○	○	×	×	×	×	×	×	×	×	×	×	×	×	
20us	×	×	×	×	●	●	●	●	○	○	○	○	○	○	○	○	○	×	×	×	×	×	×	×	×	×	
50us	×	×	×	×	×	●	●	●	○	○	○	○	○	○	○	○	○	○	×	×	×	×	×	×	×	×	
100us	×	×	×	×	×	×	●	●	○	○	○	○	○	○	○	○	○	○	○	×	×	×	×	×	×	×	
200us	×	×	×	×	×	×	×	●	○	○	○	○	○	○	○	○	○	○	○	○	○	×	×	×	×	×	
500us	×	×	×	×	×	×	×	×	○	○	○	○	○	○	○	○	○	○	○	○	○	×	×	×	×	×	

X: Not available ●: Available when replaying only ○: Available when replaying and real time

Sampling Interval	Time/DIV																									
	ms								s						min						hour					
	1	2	5	10	20	50	100	200	500	1	2	5	10	20	30	1	2	5	10	20	30	1	2	5	10	12
1ms	×	×	×	○	○	○	○	○	○	○	○	○	○	○	○	○	×	×	×	×	×	×	×	×	×	×
2ms	×	×	×	×	○	○	○	○	○	○	○	○	○	○	○	○	×	×	×	×	×	×	×	×	×	×
5ms	×	×	×	×	×	○	○	○	○	○	○	○	○	○	○	○	○	×	×	×	×	×	×	×	×	×
10ms	×	×	×	×	×	×	○	○	○	○	○	○	○	○	○	○	○	○	×	×	×	×	×	×	×	×
20ms	×	×	×	×	×	×	×	○	○	○	○	○	○	○	○	○	○	○	○	○	○	○	○	○	×	×
50ms	×	×	×	×	×	×	×	×	○	○	○	○	○	○	○	○	○	○	○	○	○	○	○	○	○	○
100ms	×	×	×	×	×	×	×	×	×	○	○	○	○	○	○	○	○	○	○	○	○	○	○	○	○	○
200ms	×	×	×	×	×	×	×	×	×	×	○	○	○	○	○	○	○	○	○	○	○	○	○	○	○	○
500ms	×	×	×	×	×	×	×	×	×	×	×	○	○	○	○	○	○	○	○	○	○	○	○	○	○	○
1s	×	×	×	×	×	×	×	×	×	×	×	×	○	○	○	○	○	○	○	○	○	○	○	○	○	○
2s	×	×	×	×	×	×	×	×	×	×	×	×	×	○	○	○	○	○	○	○	○	○	○	○	○	○
5s	×	×	×	×	×	×	×	×	×	×	×	×	×	×	○	○	○	○	○	○	○	○	○	○	○	○
10s	×	×	×	×	×	×	×	×	×	×	×	×	×	×	×	○	○	○	○	○	○	○	○	○	○	○
20s	×	×	×	×	×	×	×	×	×	×	×	×	×	×	×	×	○	○	○	○	○	○	○	○	○	○
30s	×	×	×	×	×	×	×	×	×	×	×	×	×	×	×	×	×	○	○	○	○	○	○	○	○	○
1min	×	×	×	×	×	×	×	×	×	×	×	×	×	×	×	×	×	×	○	○	○	○	○	○	○	○

X: Not available ○: Available when replaying and real time

Zone division

This is a function to divide the Y-axis of the Y-T graph waveform into multiple zones and displays the graphs so that they do not overlap. Select from 1-zone (no zone division), 2-zone division, 4-zone division or 8-zone division.

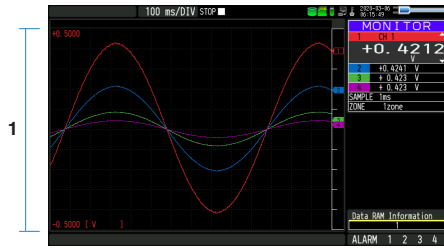

1-zone (no zone division)

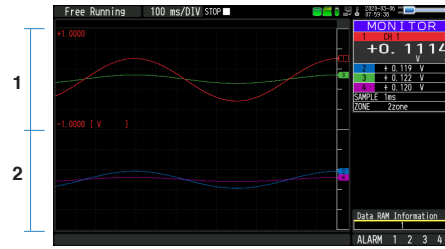

2-zone division

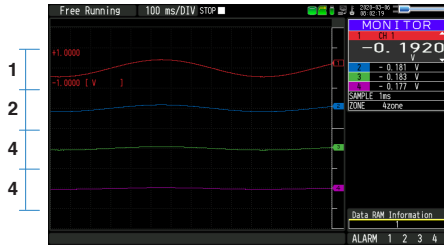

4-zone division

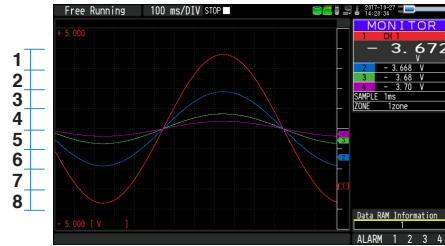

8-zone division

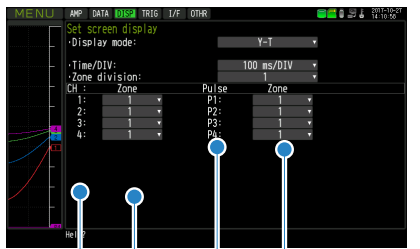

Analog CH

Pulse CH

Analog CH
Zone allocation setting

Pulse CH
Zone allocation setting

Analog CH and pulse CH can be freely assigned to each zone.

Logic zone

Logic zone can be set in its own zone, which is different from analog CH and pulse CH. Logic CH1 to Logic CH4 are displayed together in one logic zone.

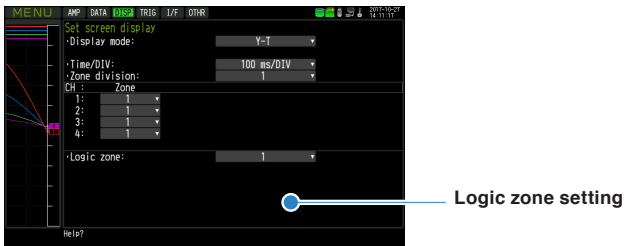
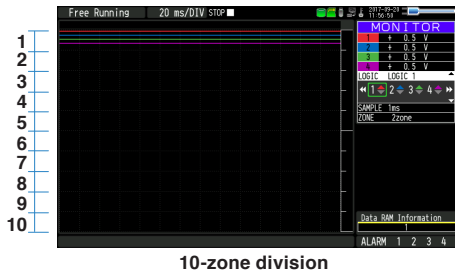

(3)-2 Logging display

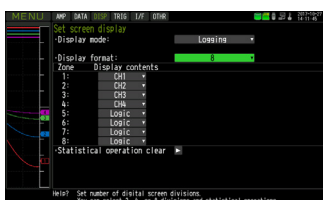

Setting	Description
Display mode	Set the display mode of screen. Y-T, Y-T (full screen), Logging, XY
Display format	Set the display format of the logging screen. 2-division, 4-division, 8-division, Statistical operation * To select the real time statistics calculation screen, select the statistical operation.
Display contents	Select the display contents of the logging screen. Analog CH number can be selected. When Logic or Pulse is selected, Logic/Pulse CH number can be selected.
Statistical operation clear	Clear (initialize) real time statistical operation.

Display format

Set the display format of the logging screen.

When statistical calculation is selected, real time statistical calculation screen is displayed.

When other is selected, the logging screen is displayed.

< Logging screen >

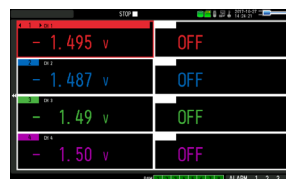

< Real time statistical calculation screen >

CH	VALUE	Max	Min	P-P	Ave
CH1	3.395	+ 3.718	- 3.718	+ 7.433	+ 0.016
CH2	3.397	+ 3.717	- 3.714	+ 7.431	+ 0.021
CH3	3.39	+ 3.73	- 3.73	+ 7.46	+ 0.02
CH4	3.37	+ 3.74	- 3.77	+ 7.51	+ 0.01
LOGIC	1.0	2.1	3.1	4.0	

Display contents

Select the content displayed on each display frame on the logging screen.

Choose from analog CH (CH1 to CH4/Pulse CH (P1 to P4)/Logic.

Same as this selected part.

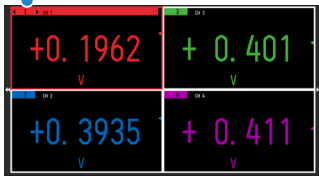

The zone allocation when divided is as shown in the figure below.

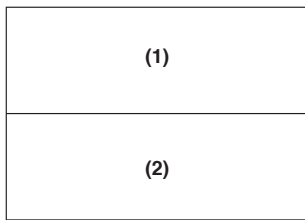

2-division

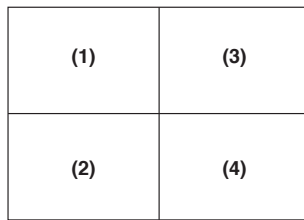

4-division

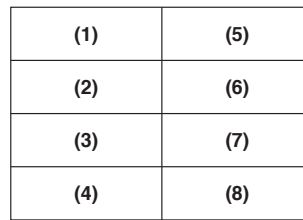

8-division

Statistical calculation clear

Clear (initialize) real time statistical calculation.

The maximum value, the minimum value and the P-P value are initialized to 0 respectively.

The average value is set to the initial value of 0, and after recording the data for more than 1 point, the average value will be displayed.

(3)-3 XY display

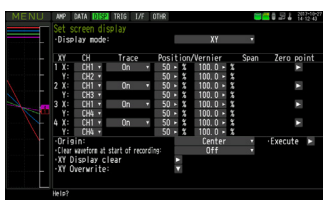

Setting		Description
Display mode		Set the display mode of the screen. Y-T, Y-T (full screen), Logging, XY
CH		Set the X- axis and Y- axis of XY graph. CH1 to CH4
Trace		Set the trace of XY graph. Off, On Waveforms are not displayed on the screen when trace is Off. Also they are not displayed on the digital display.
Position		Set the XY position. 0% to 100%
Vernier		Set the XY vernier. 40 to 100% * The range depends on the range setting.
Span	Upper limit	Set the span. You can set it when the analog CH in the Span mode is set on the axis.
	Lower limit	
Zero point		Automatic zero adjustment of the analog CH set to the X-axis and Y-axis is performed.
Origin		Set the origin position in the Y graph. Center, Lower left
Execute		Initialize the XY position to the set origin.
Clear waveform at the start of recording.		Set the enable or disable of XY waveform clearing at the start of capturing. Off, On
XY display clear		Perform the XY waveform clear manually.
XY Overwrite	Select File	Select the image file to be overwritten and then perform the overwriting.
	Overwrite clear	The XY overwrite is cleared and completed.

CH (X-axis/Y-axis CH setting)

Set X-axis and Y-axis of XY graph.

You can select from among analog CHs.

Trace

Set the trace of XY waveform.

XY-CH which trace is set to Off is not displayed on the graph and the digital display.

Position (XY position)

Set the XY position.

This setting is used for XY display only.

This differs from the position setting for Y-T waveform display (The position setting that can be operated at Y-T waveform + Digital display)..

For XY position setting, set the drawing reference position to 0% for the lower left and 100% for the upper right of the XY graph.

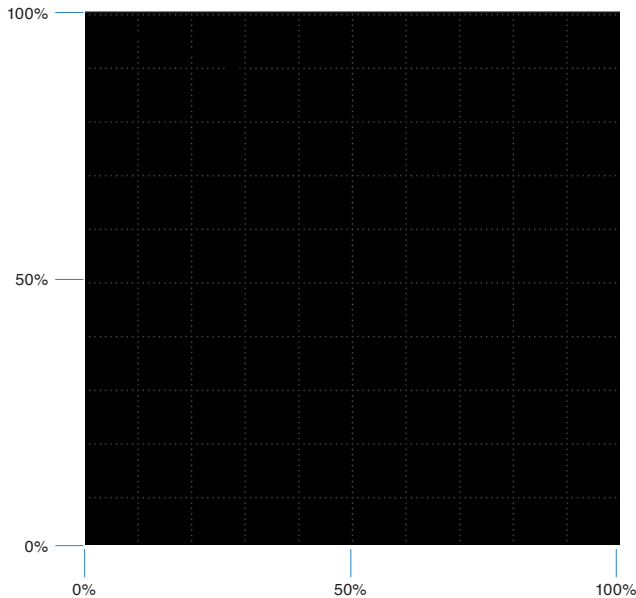

The measurement range displayed on the graph by the XY position setting is as follows.

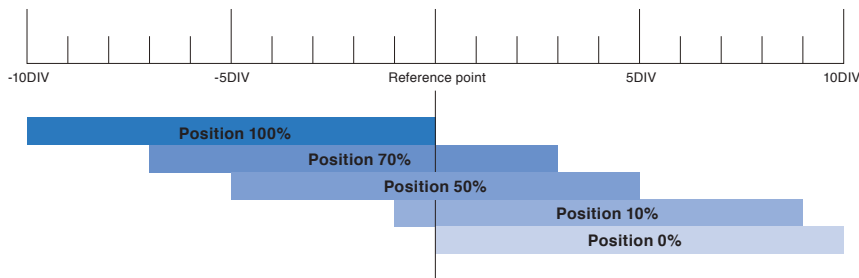

As shown in the figure above, the display range moves 10DIV area in parallel through the XY position setting.

XY position setting is set only for XY graph.

Position reference point differs between range mode and span mode.

- Range mode

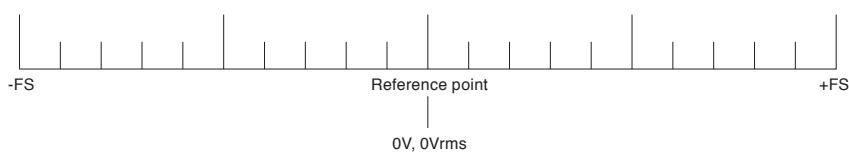

The position reference point in Range mode is 0V or 0Vrms.

• Span mode

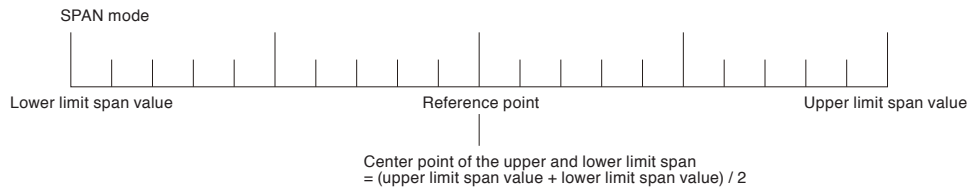

The position reference point in Span mode is the center point between the upper limit span value and the lower limit span value.

Also, the lower limit span value is placed at -5DIV position and the upper limit span value is placed at 5DIV position.

For details of Range mode/Span mode, refer to "3.3 Operation Modes"-(3) XY waveform display" - "Range mode/Span mode".

Vernier

Set the XY Vernier.

This setting is for XY display setting only.

Vernier is a function to adjust the amplitude (gain).

Adjust the display width range of the waveform displayed on the XY graph.

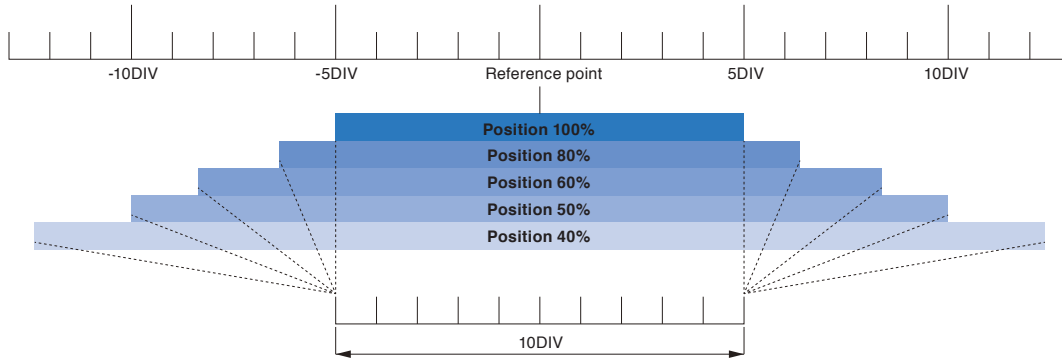

When the Vernier is set to 100%, it magnifies equally along the axis. Therefore the waveform display reflects the Vernier setting magnification.

For example, when the Vernier is set to 80%, it is displayed with a size of 80% compared with 100%.

(The above figure shows the sample when the XY position is set to 50%)

The setting range for the Vernier setting of the Range mode depends on the set range.

V/DIV range	Vernier setting range
1mV/DIV	100% to 50%
2mV/DIV	100% to 40%
5mV/DIV	100% to 50%
10mV/DIV	100% to 50%
20mV/DIV	100% to 40%
50mV/DIV	100% to 50%
100mV/DIV	100% to 50%
200mV/DIV	100% to 40%
500mV/DIV	100% to 50%
1V/DIV	100% to 50%
2V/DIV	100% to 40%
5V/DIV	100% to 50%
10V/DIV	100% to 50%
20V/DIV	100% to 40%
50V/DIV	100% to 50%

V/DIV range	Vernier setting range
0.5mVrms/DIV	100% to 50%
1mVrms/DIV	100% to 40%
2.5mVrms/DIV	100% to 50%
5mVrms/DIV	100% to 50%
10mVrms/DIV	100% to 40%
25mVrms/DIV	100% to 50%
50mVrms/DIV	100% to 50%
100mVrms/DIV	100% to 40%
250mVrms/DIV	100% to 50%
500mVrms/DIV	100% to 50%
1Vrms/DIV	100% to 40%
2.5Vrms/DIV	100% to 50%
5Vrms/DIV	100% to 50%
10Vrms/DIV	100% to 40%
25Vrms/DIV	100% to 50%
50Vrms/DIV	100% to 50%

Vernier setting of the Span mode can be set within the range of 40 to 100%.

Also, the lower span limit is set to -5DIV position and the upper span limit is set to 5DIV position.

Span

Span can be selected when Span mode CH is set on X-axis and Y-axis.

This is a common setting with Span set in Y-T waveform display (AMP menu).

Changing the Span setting affects the position reference point and the basic range of the vernier (the range displayed in the graph when the vernier is set to 100%)

For details of the Range mode/Span mode, refer to "3.3 Operation Modes"-"(3) XY waveform display"-"Range mode/Span mode".

Zero point

Automatic zero adjustment is performed.

Automatic zero adjustment for 2CH of the analog CH set on the X-axis and Y-axis is performed.

When the analog CH input is set to temperature, automatic zero adjustment is not performed.

For details of automatic zero point adjustment, refer to "3.5 Setting Menues" - "(1) AMP settings" - "Zero adjustmentfunction"

Referring to "3.5 Setting Menus" – "(1) AMP Menu" – "Automatic zero adjustment" – "Zero adjustment reset", please reset for each analog CH.

Origin

Set the origin of the X-Y graph.

Center and lower points left can be selected.

When "Execute" is selected, the XY position is initialized to the position selected as the origin.

- Initialization position

Center: X-axis position 50%, Y-axis position 50%

Lower left : X-axis position 0%, Y-axis position 0%

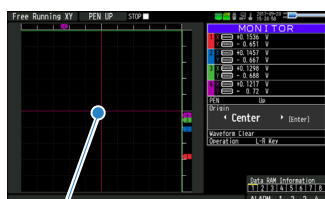

Center: Origin

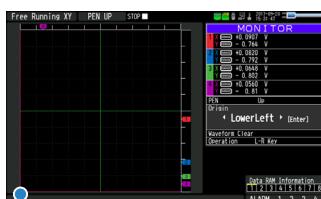

Origin: Lower left

Waveform clears at the start of recording

Set whether to erase the XY waveform display (pen trajectory) at the start of capturing.

When set to On, the XY waveform display is erased at the start of recording.

XY display clear

Manually erase the XY waveform display (pen trajectory).

The erased waveforms cannot be restored, hence save the screen copy from the FILE menu if necessary.

For details of XY display clear, refer to "3.5 Setting Menus" - "(7) FILE menu" - "Screen copy".

XY Overwrite



Setting	Description
(1) Select File	Select the image file to be overwritten and then perform the XY overwriting. The image file is a screen copy of the file menu in XY display, and the storage range is the image file saved on the waveform screen.
(2) Overwrite clear	The XY overwrite image is erased and the XY overwriting is completed.

You can display the image file as a "Waveform screen" to be the background image of the XY graph at XY waveform display.

(Other than the waveform screen image file saved by this device are not available.)

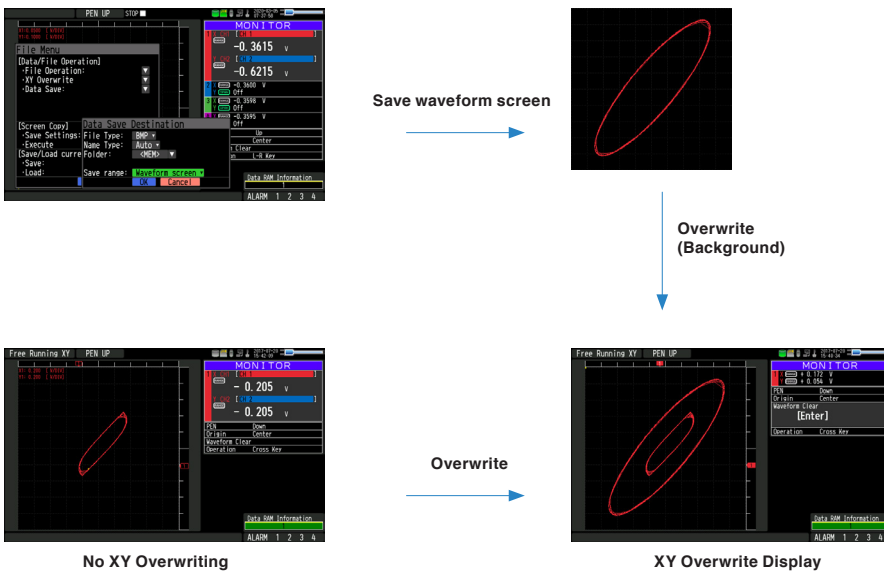

The background image to be overwritten is not erased even if operating the XY display clear.

Perform "Overwrite clear" separately.

* It is overwritten even during replaying.

CAUTION

The Overwrite is a function to read the image as image data to the background. For the waveform displayed in the background, even if you change the XY position and VERNIER setting, etc., it will not be overwritten.

(4) TRIG settings

Set the trigger condition and the alarm.



Setting		Selections available
Start Source		Set the type of start trigger. Off, Level, Alarm, External input, Specified time, Specified day of the week, Constant time
[Off]		Set to Off when not using trigger.
[Level value]	Combination	Set the trigger signal detecting method and combination for each CH. Level OR, Level AND, Edge OR, Edge AND
	Mode	Set the level of trigger mode. Analog: Off, H (Rising), L (Falling), Window In, Window Out Logic: Off, H, L Pulse: Off, H (Rising), L (Falling), Window In, Window Out * The value in the parentheses is displayed when the Combination is set to Edge.
	Level	Set the trigger level value. Set by numerical value.
[Alarm]	Alarm port number	Set the alarm output port number that generates the trigger. 1, 2, 3, 4
[External input]		Set it when inputting the trigger signal from the outside.
[Specified time] Specified time setting	Time setting range	Set the unit for repeating the trigger time. Absolute time, Year, Month, Day, Hour, Minute
	Date	Set the trigger date. Jan. 1, 2000 – Dec. 31, 2035 * Settable item varies depending on time setting range setting.
	Time	Set the trigger time. 0 hour 0 minute 0 second to 23 hour 59 minute 59 second * Settable item varies depending on time setting range setting.
Specified day of the week setting	Day of the week	Set the day of the week when the trigger is generated. Set to On or Off for Sunday to Saturday individually.
	Time	Set the trigger time. 0 hour 0 minute 0 second to 23 hour 59 minute 59 second
[Constant time] Certain period of time setting		Set the time length of the trigger. 0 hour 0 minute 1 second to 9999 hour 59 minute 59 second

Setting		Selections available
Stop Source		Set the type of start trigger. Off, Level, Alarm, External input, Specified time, Specified day of the week, Constant time
	[Off]	Set to Off when not using trigger.
[Level value]	Combination	Set the trigger signal detecting method and combination for each CH. Level OR, Level AND, Edge OR, Edge AND
	Mode	Set the level of trigger mode. Analog: Off, H (Rising), L (Falling), Window In, Window Out Logic: Off, H, L Pulse: Off, H (Rising), L (Falling), Window In, Window Out * The value in the parentheses is displayed when the Combination is set to Edge.
	Level	Set the trigger level value. Set by numerical value.
[Alarm]	Alarm port number	Set the alarm output port number that generates the trigger. 1, 2, 3, 4
[External input]		Set it when inputting the trigger signal from the outside.
[Specified time] Specified time setting	Time setting range	Set the unit for repeating the trigger time. Absolute time, Year, Month, Day, Hour, Minute
	Date	Set the trigger date. Jan. 1, 2000 – Dec. 31, 2035 * Settable item varies depending on time setting range setting.
	Time	Set the trigger time. 0 hour 0 minute 0 second to 23 hour 59 minute 59 second * Settable item varies depending on time setting range setting.
[Specified day of the week] Specified day of the week setting	Day of the week	Set the day of the week when the trigger is generated. Set to On or Off for Sunday to Saturday individually.
	Time	Set the trigger time. 0 hour 0 minute 0 second to 23 hour 59 minute 59 second
[Constant time] Specified period of time setting		Set the time length of the trigger. 0 hour 0 minute 1 second to 9999 hour 59 minute 59 second
Pre-trigger mode		Set the pre-trigger operation mode. Prioritize trigger, Prioritize pre-trigger capture * You can set the mode only when the capturing destination is internal RAM.
Pre-trigger data points		Set the number of data points for pre-trigger capture. 0 to Number of capturing points of internal RAM data * You can set the capturing points only when the capturing destination is internal RAM.
Repeat		Set the repeat capturing. Off, On
Repeat interval mode		Set the repeat interval mode. Start - Start, Stop - Start
Repeat int.		Set the repeat interval. 0 hour 0 minute 0 second to 9999 hour 59 minute 59 second
Alarm Settings	Mode	Set the alarm level mode. Analog: Off, H, L, Window In, Window Out Logic: Off, H, L Pulse: Off, H, L, Window In, Window Out
	Level	Set the alarm level value. Set by numerical value.
	Output	Set the alarm output CH when an alarm occurs. 1 to 4
Alarm Hold		Set whether to hold the alarm occurrence status. On, Off
Output 1		Set the output contents of the alarm output terminal 1. Alarm output 1, Trigger output

(4)-1 Start side source setting

This is used to specify trigger conditions to start data capture.

Selection item	Description
Off	Starts capturing data unconditionally when you press the [START/STOP] key.
Level	Starts capturing data when a specified level is reached. -> When Level is selected, the condition for each channel must be set. Refer to "Trigger Level Settings/Alarm Level Settings" described below.
Alarm	Starts capturing data when an alarm is generated in the specified alarm port.
External Input	Starts capturing data when an input signal is received from an external trigger terminal. * A trigger is established at a transition from 5 V (open) to 0 V (shorted to the ground). A falling edge operation occurs.
Date	Refer to "Specified time setting" described below.
Weekly	Starts capturing data at the specified time on days of week for which On is set. Example: On is set for Mon, Tue, Wed, Thu, and Fri, Off is set for Sun and Sat, and 9:00 is set as the time. Starts capturing data at 9:00 on weekdays. Does not start capturing data on Sat and Sun.
Duration	Starts capturing data when a specified length of time elapses.

(4)-2 Stop side source setting

This is used to specify trigger conditions to stop data capture.

Selection item	Description
Off	Stops capturing data unconditionally when you press the [START/STOP] key.
Level	Stops capturing data when a specified level is reached. -> When Level is selected, the condition for each channel must be set. Refer to "Trigger Level Settings/Alarm Level Settings" described below.
Alarm	Stops capturing data when an alarm is generated in the specified alarm port.
External Input	Stops capturing data when an input signal is received from an external trigger terminal. * A trigger is established at a transition from 5 V (open) to 0 V (shorted to the ground). A falling edge operation occurs.
Date	Refer to "Specified time setting" described below.
Weekly	Stops capturing data at the specified time on days of week for which On is set. Example: On is set for Mon, Tue, Wed, Thu, and Fri, Off is set for Sun and Sat, and 9:00 is set as the time. The data is captured at 9:00 on weekdays. Does not stop capturing data on Sat and Sun..
Duration	Stops capturing data when a specified length of time elapses.

CHECKPOINT

When External Input is used as the trigger source, no stop trigger is accepted for 50 ms after capture is started.

(4)-3 Pre-trigger

For pre-trigger, set the number of data points to record before trigger is set off.

* Pre-trigger can be selected only when the capturing destination is set to the internal RAM.

The data before the trigger point is called “pre-trigger data”, and the data after the trigger point is called “post-trigger data”.

Initiate the ring capture for pre-trigger data before the trigger is set off.

When the trigger sets off, the capturing of the pre-trigger data is completed, the remaining post-trigger data is captured and then completed.

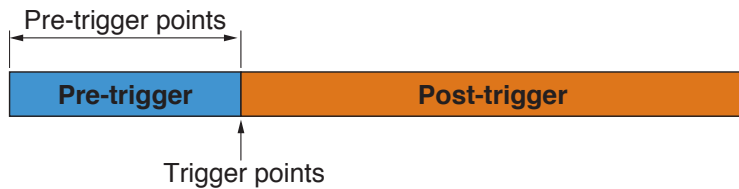

Pre-trigger mode

Setting	Description
Prioritize trigger	When a trigger launches during pre-trigger, the pre-trigger capture is completed.
Prioritize pre-trigger capture	Trigger is not accepted until pre-trigger capture is completed. Even if a trigger sets off, it is ignored.

< Prioritize trigger >

When a trigger launches during pre-trigger capturing, and capturing for the pre-trigger points has not been completed, pre-trigger capture is completed at the time of trigger and post-trigger data is captured immediately.

Below is the case when a trigger sets off before the capturing of the pre-trigger points is completed.

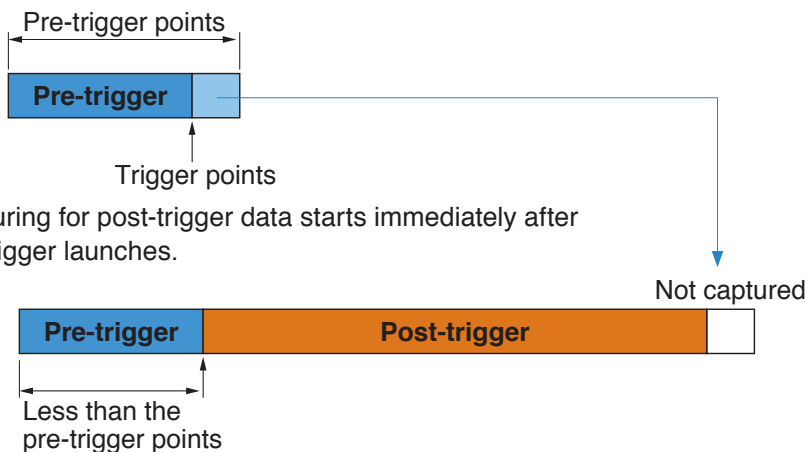

Capturing for post-trigger data starts immediately after the trigger launches.

The total data after capturing is less due to the uncaptured pre-trigger point.

The pre-trigger data which could not be captured remains as is and the total number of data points is reduced.

* When a trigger launches after completing the data corresponding to the pretrigger data points, there is no uncaptured data.

< Prioritize pre-trigger capturing >

When a trigger sets off during pre-trigger capturing, the trigger is ignored.

The trigger that initiates after the data capture corresponding to the pretrigger data points is completed is effective.

Below is the case when a trigger sets off before the data capture of the pretrigger data points is completed.

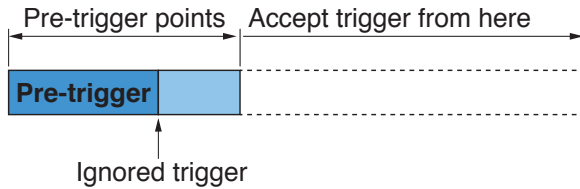

When a trigger launches before the data capture corresponding to the pretrigger data points is completed, the trigger is ignored.

Trigger is accepted after the data capture corresponding to the pretrigger data points is completed.

After the trigger is accepted, the capturing of the post trigger data initiates.

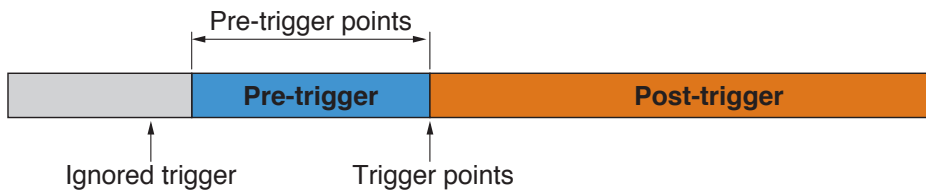

(4)-4 Repeated capturing

This is used to enable or disable the repeat function to conduct repeated capturing.

Selection item	Description
Off	The repeat function is disabled.
On	The repeat function is enabled. After one capture ends, the next capture starts (If the start side source setting is not Off, this device waits for a trigger).

Repeat capture is available when the capturing destination is internal RAM or when the stop trigger is set.

Repeat interval mode and repeat interval

When the repeat capture function is set to On, you can set the time interval until the next recording starts. The time interval range is set in the repeat interval mode.

< Repeat interval mode >

Setting	Description
Start - Start	Set the time from the previous capture start (including waiting for trigger) to the start of next recording.
Stop - Start	Set the time from the previous capture stop to the start of next recording.

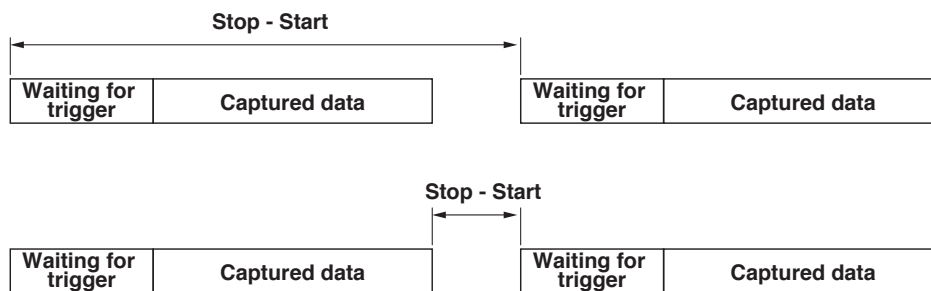

When the time interval between start and stop is set and the set time interval has passed at the end of the capturing, repeat operation starts immediately.

When the repeat interval is set to 0 hour 0 minute 0 second, repeat operation starts immediately.

CAUTION

The repeat interval may be longer than the set time.

(4)-5 Alarm settings

Alarm level settings

This is used to set the alarm generation conditions and output destination, etc.

When the conditions specified are met, the alarm output terminal (for which an output destination number must be specified for each channel) sets off an alarm.

For the CH condition settings, refer to "Trigger Level Settings/Alarm Level Settings" described below.

Alarm occurrence hold

If "Alarm occurrence hold" is selected, and once the established conditions have been met, the alarm status will not be cleared, regardless of whether or not the conditions continue to be met.

(Press the [CURSOR] key to cancel it)

Output 1 selection

Select Alarm output 1 or Trigger output.

Setting	Description
Alarm output 1	Alarm output 1 is output from the Alarm output 1/Trigger output terminal.
Trigger output	Trigger is output from the Alarm output 1/Trigger output terminal.

Trigger level settings/Alarm level settings

Specifies detailed conditions for each channel when the start and stop side source settings are Level. The configuration of the level trigger is as shown in the figure below.

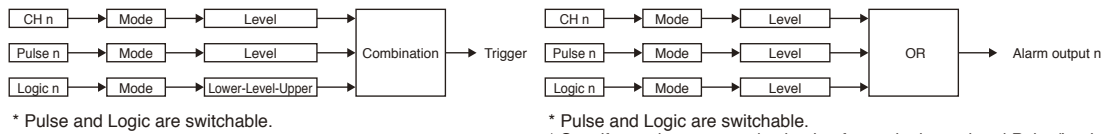

* Pulse and Logic are switchable.

* Pulse and Logic are switchable.

* Specify an alarm output destination for each channel and Pulse/Logic. Each of the alarms is ORed at the output destination.

Example: If you specify 1 as the output destination of 1CH and 2CH and 2 as that of 3CH and 4CH, Alarm Output 1 occurs when one of 1CH and 2CH meets the conditions, and Alarm Output 2 occurs when one of 3CH and 4CH meets the conditions.

< Trigger setting >

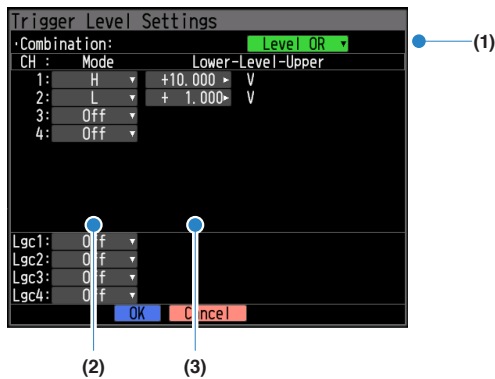

< Alarm setting >

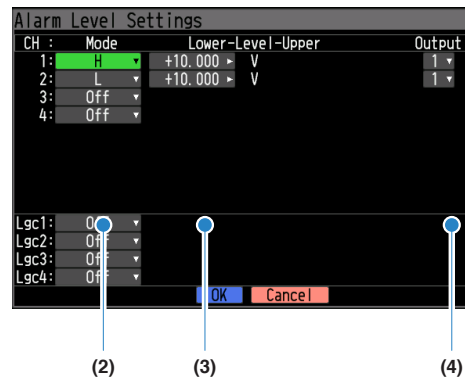

Setting	Description
(1) Combination	Set the combination of the trigger condition set for each channel. Level OR: Starts (stops) capturing when a set trigger condition is satisfied. The level operation is determined by each condition. Level AND: Starts (stops) capturing when all the set trigger conditions are satisfied. The level operation is determined by each condition. Edge OR: Starts (stops) capturing when a set trigger condition is satisfied. The each operation is determined by each condition. Edge AND: Starts (stops) capturing when all the set trigger conditions are satisfied. The each operation is determined by each condition. * Only for trigger setting.
(2) Mode	Set the mode to compare trigger/alarm for each channel. Off: Trigger/alarm of set CH is disabled. H (Rising): Trigger/alarm is established when the input signal exceeds the set level. L (Falling): Trigger/alarm is established when the input signal is lower than the set level. Window In: Trigger/alarm is established when the input signal is within the range between the upper level and lower level. * Logic CH has no setting. Window Out: Trigger/alarm is established when the input signal is out of the range between the upper level and lower level. * Logic CH has no setting.
(3) Level	Set the level to compare trigger/alarm. Set the comparison level to one place when the mode is H (Rising) or L (Falling). Set the comparison level to two places when the mode is Window In or Window Out.
(4) Output	Set the alarm output CH when an alarm occurs. * Only for alarm setting

* The operation in parentheses () is for edge operation.

* When the alarm is set, the level operation is fixed.

Level and Edge operations

In the Level operation, a trigger is assumed to be generated if the trigger conditions are met when the [START] key is pressed.

In the Edge operation, a trigger is not assumed to be generated even if the trigger conditions are met when the [START] key is pressed.

A trigger is assumed to be generated when the trigger conditions, after not being met, are met again.

* A trigger is still assumed to be generated even if the trigger conditions are met once in the Edge operation and then are no longer met.

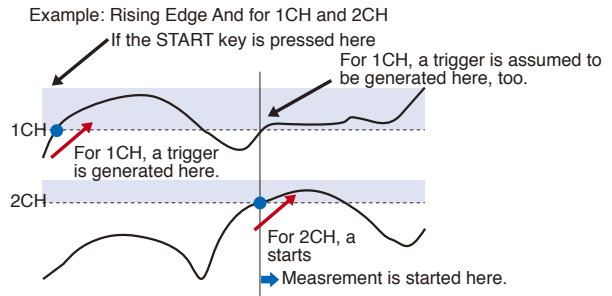
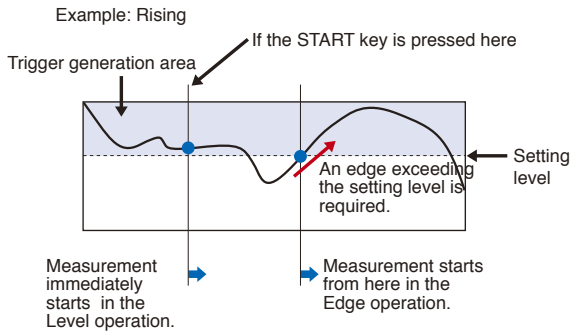

Trigger and Alarm operations (H (Rising), L (Falling), Window In, Window Out)

H (Rising) : A trigger/alarm is generated when the input signal reaches specified level.

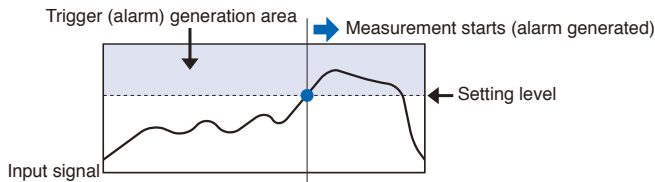

L (Falling) : A trigger/alarm is generated when the input signal reaches the specified level.

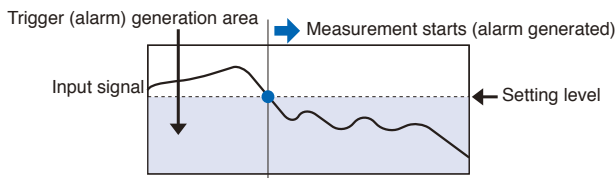

Win In : Used to specify the upper and lower limits. When the input signal level is enters specified limit levels, a trigger/alarm is generated.

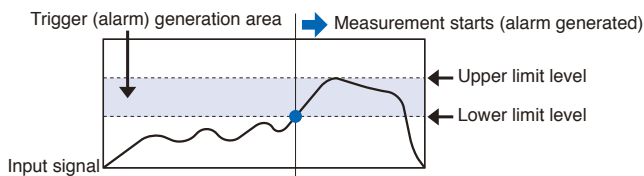

Win Out : Used to specify the upper and lower limits. When the input signal level exits specified limit levels, a trigger/alarm is generated.

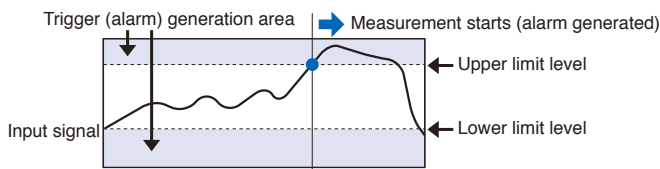

Dead zones (hysteresis) of trigger and alarm levels

Trigger and alarm levels are provided with a dead zone (hysteresis) in order to prevent false detection due to noise.

The following figure shows the dead zone (hysteresis).

< Mode: H (Rising) >

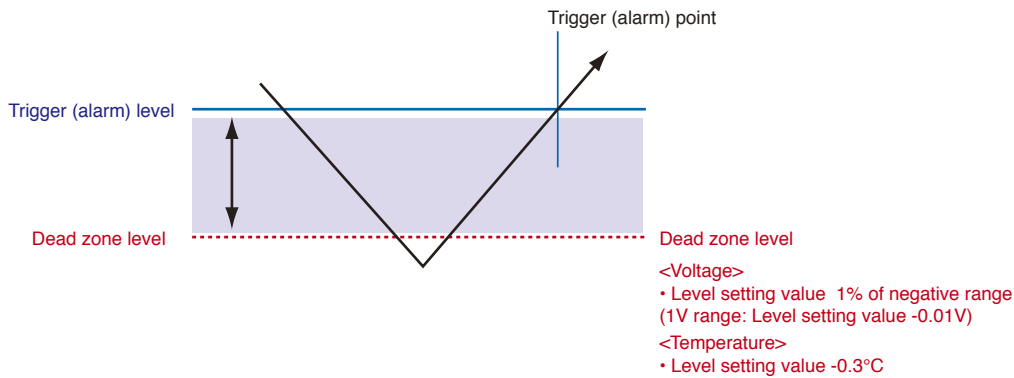

< Mode: L (Falling) >

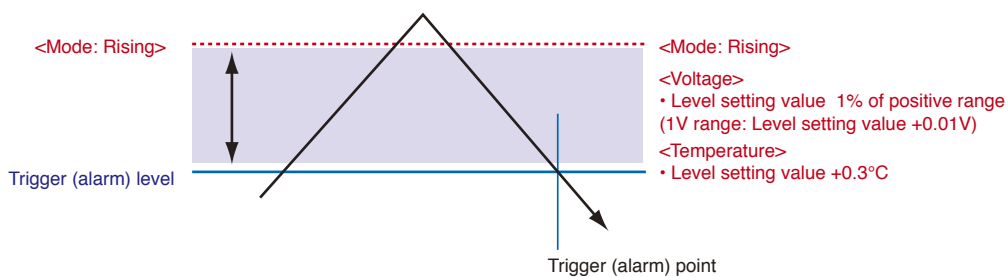

CHECKPOINT

- The upper limit values within the mode range and the lower limit values out of the mode range are dead zone level as well.
 - When the detected alarm drops below the dead zone level, alarm is cleared. (When the alarm is not retained)
- <Example>When measuring temperature, the level released after the alarm generated is shown below.
- H (Rising) setting: Setting value -0.3°C/0.3°F
 - L (Falling) setting: Setting value +0.3°C/0.3°F
- Dead zone is not provided for pulse signals.

Logic trigger

The trigger of logic CH is compared with the pattern against setting the logic 4CH set in the mode.

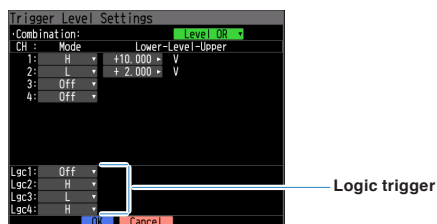

A trigger initiates when the input signal matches the set pattern.

Logic CH set to Off becomes “Don’t Care”, and it is regarded as a pattern match even if the input signal is H or L.

However, when all logic CHs are set to Off, the logic trigger is invalid and is not used.

Specified time setting

By setting the time range of the specified time trigger, you can set the time trigger repeatedly.

Time setting range	Settable area	Description
Absolute time	Year, Month, Day, Hour, Minute, Second	Specify the absolute time. The trigger is output only once.
Year	Month, Day, Hour, Minute, Second	The trigger is output once a year.
Month	Day, Hour, Minute, Second	The trigger is output once a month.
Day	Hour, Minute, Second	The trigger is output once a day.
Hour	Minute, Second	The trigger is output once an hour.
Minute	Second	The trigger is output once a minute.

If the absolute time is set using the specified time trigger when trigger repeat setting is set to On, no trigger occurs at repeat operation. (Trigger occurs only once.)

To set the repeat setting, be sure to set not using the absolute time.

Example:

Specified time range: hour

Time: 12 minutes 34 seconds

A trigger occurs every 12 minutes and 34 seconds.

1 hour 12 minutes 34 seconds

15 hours 12 minutes 34 seconds

A trigger occurs every hour as described above.

(5) Interface settings

This menu is used to specify conditions for PC connection.



Setting		Selection available		
End-of-line character		Set the end-of-line character for sending and receiving the control commands. CR + LF, CR, LF		
USB settings	USB ID	Set the identification ID when connecting between PC and USB. 0 to 9		
TCP-IP settings	TCP/IP Detailed	IPAddr Auto Acq.	Set the IP address automatic acquisition. On, Off	
		IP Address	Set the IP address. 0 to 255 . 0 to 255 . 0 to 255 . 0 to 255 * When the IP address is set automatically, the automatically set IP address is displayed.	
		Sub-net mask	Set the subnet mask. 0 to 255 . 0 to 255 . 0 to 255 . 0 to 255 * When the IP address is set automatically, the automatic sub-net mask is displayed.	
		Port number	Set the port number of the control command server. 1024 to 65535 * This is the port number specified when connecting our application (GL980-2000_APS).	
		Gateway	Set the gateway. 0 to 255 . 0 to 255 . 0 to 255 . 0 to 255 * When the IP address is set automatically, the automatic gateway address is displayed.	
		DNS address	Set the address of the DNS server. 0 to 255 . 0 to 255 . 0 to 255 . 0 to 255 * When the IP address is set automatically, the automatic DNS server address is displayed.	
		Keep Alive	Set the forced disconnection time when no communication is detected by the control command server. Off, 10 seconds, 30 seconds, 1 minute, 10 minutes, 30 minutes, 1 hour	
	Apply Settings		Confirm TCP/IP settings and restart TCP/IP processing.	
	FTP/WEB server settings	FTP Client		Perform the FTP connection settings for backup destination. For details, refer to "FTP/WEB server setting".
		FTP server port number		Set the port number of the FTP server installed in this device. 0 to 65535
WEB server port number		Set the port number of the WEB server installed in this device. 0 to 65535		
Email settings	E-mail Send Settings	Destination settings	To	Set the destination (address) of the E-mail. Enter the string of up to 63 characters.
			CC1 to CC3	Set the destination of the E-mail (broadcast 1 to 3). Enter the string of up to 63 characters.
			Subject	Set the subject of the E-mail. Enter the string of up to 63 characters.

Setting		Selection available	
	Notification settings	Alarm	Set the E-mail send when an alarm occurs. Off, On
		Low battery	Set the E-mail send when the internal battery lowers. Off, On
		Drive free space	Set the E-mail send when the drive free capacity during recording is low. Off, On
		Periodic notifications	Set the periodic notification E-mail send. Off, 1 hour, 2 hours, 3 hours, 6 hours, 12 hours, Specified time * Set the specified time to the hour : minute : second.
	E-Mail Send Server Settings	Send (SMTP) Server Name	Set the E-mail Send Server Name (server address). Enter string up to 63 characters. * Enter the domain name or IP address. * Enter the server name notified from the mail provider.
		SMTP port number	Set the port number of the E-mail Send Server. 0 to 65535 * Enter the port number notified from the mail provider.
		Time zone	Set time zone. UTC-12:00 to UTC+13:00 * This is a common setting for time zone setting with POP3 server setting and NTP setting.
		SMTP authentication method	Set the SMTP authentication method. Off, POP before SMTP, SMTP-AUTH
		SMTP-AUTH	Set the authentication method of SMTP-AUTH. PLAIN, LOGIN, CRAM-MD5, DIGEST-MD5
		POP3 server settings	Set it when POP before SMTP is selected in SMTP authentication method.
		Receive (POP3) Server Name	Set the E-mail receiving server name (server address). Enter the string of up to 63 characters. * Enter the domain name or IP address. * Enter the server name notified from the mail provider.
		POP3 port number	Set the port number of the E-mail receiving server. 0 to 65535 * Enter the port number notified from the mail provider.
		Time zone	Set the time zone. UTC-12:00 to UTC+13:00 * It is common setting with the time zone setting of SMTP server setting and NTP setting.
		POP3 encryption	Set the encryption of POP3 server. Off, StartTLS, Over SSL * Set the encryption notified from the mail provider.
		The same as SMTP	Set whether to use the same POP3 user name and POP3 password as SMTP user name and SMTP password. No, Yes
		POP3 user name	Set the user name to log in to the POP3 server. Enter the string of up to 63 characters.
		POP3 password	Set the password to log in to the POP3 server. Enter the string of up to 63 characters.
		SMTP user name	Set the user name to log in to the SMTP server. Enter the string of up to 63 characters.
	SMTP password	Set the password to log in to the SMTP server. Enter the string of up to 63 characters.	
	SMTP encryption	Set the encryption of the SMTP server. Off, StartTLS, Over SSL * Set the encryption notified from the mail provider.	
E-mail Address	Set your own E-mail address. Enter the string up to 63 characters.		
Test email	A test E-mail is sent.		
Identification name	Set the specified name to be used in our application (GL980-2000_APS). Enter the string of up to 15 characters.		
Apply Settings	Confirm TCP/IP settings and restart TCP/IP processing.		

(5)-1 End-of-line character

Specifies the line feed code.

Selection item	Description
CR+LF	Starts a new line with CR+LF code (default value).
LF	Starts a new line with LF code.
CR	Starts a new line with CR code.

* For details of I/F command, refer to GL980/GL2000-SDK.

(5)-2 USB settings

Set the USB ID number of this product.

Set the range between 0 and 9.

When controlling multiple devices with one PC, set this so that the USB ID does not overlap.

(5)-3 TCP/IP advanced settings

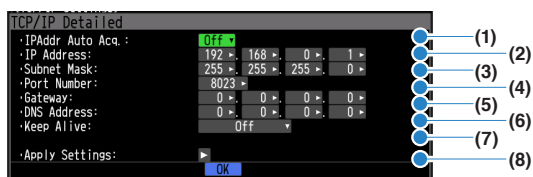

Setting	Description
(1) IPAddr Auto Acq.	Set the IP address automatic acquisition. On, Off
(2) IP Address	Set the IP address. 0 to 255 . 0 to 255 . 0 to 255 . 0 to 255 * When the IP address is set automatically, the automatic set IP address is displayed.
(3) Sub-net mask	Set the subnet mask. 0 to 255 . 0 to 255 . 0 to 255 . 0 to 255 * When the IP address is set automatically, the automatic set sub-net mask is displayed.
(4) Port number	Set the port number of the control command server. 1024 to 65535 * This is the port number specified when connecting to our application (GL980-2000_APS).
(5) Gateway	Set the gateway. 0 to 255.0 to 255.0 to 255.0 to 255 * When IP address is set automatically, the automatic set gateway address is displayed.
(6) DNS address	Set the address of the DNS server. 0 to 255 . 0 to 255 . 0 to 255 . 0 to 255 * When the IP address is set automatically, the automatic set DNS server address is displayed.
(7) Keep Alive	Set forced disconnection time when no communication is detected by the control command server. Off, 10 seconds, 30 seconds, 1 minute, 10 minutes, 30 minutes, 1 hour If no communication state continues for specified time or more, the socket connection is disconnected. You should generate a communication within the set time. When using the supplied application software, note that it will be the non-communication state while the captured data is being replaying. (This function is available only for the control command server, and does not affect the Web server function and FTP server function.)
(8) Apply Settings	Confirm TCP/IP setting and restart TCP/IP processing.

CAUTION

- If the Automatic IP Address Acquisition fails (see the figure below), the IP address is not set properly. Disable the Auto IP Address Acquisition and make the settings one by one.
- After you have changed the TCP-IP settings, turn off and turn on the power, or execute Reflect Settings (The connection will force disconnect).
- When you want to use the IP address automatic acquisition function, DHCP server must be operating separately within the searchable network.

< Auto IP Address Acquisition is successful >

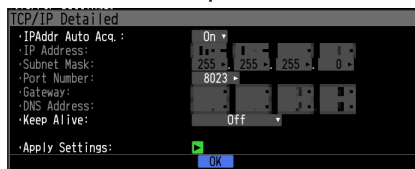

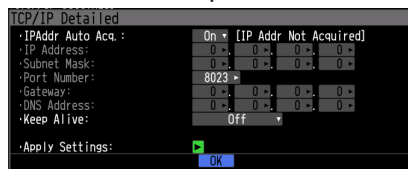

< Auto IP Address Acquisition fails >

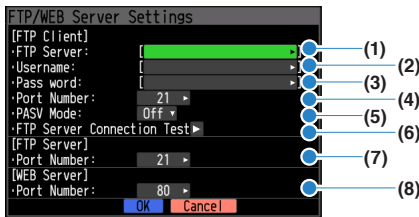

(5)-4 FTP/WEB server settings

Set the FTP server/WEB server as this device.



Selection item		Description
FTP Client	(1) FTP Server	Enter the domain name or IP address of the FTP server. (Up to 127 characters)
	(2) User Name	Enter the user name of the FTP account. (Up to 31 characters)
	(3) Password	Enter the password of the FTP account. (Up to 31 characters)
	(4) Port Number	Enter the port number of a port to be used for FTP. It is normally 21. (0 to 65535)
	(5) PASV Mode	Make the passive mode setting. ON : Should be set for communication with an external FTP server in a firewall environment. OFF : Should be set for communication with an FTP server in a normal network environment.
	(6) FTP Server Connection Test	Press right ► key to execute (Performs connection test to the FTP server.) When the connection test is performed, a message is displayed. If connection cannot be established, check the settings and perform the connection test again. * If the connection test is passed, the following message is displayed. 
FTP server	(7) Port number	Set port number of the FTP server installed in this device. (0 to 65535)
WEB server	(8) WAB number	Set port number of the WEB server installed in this device. (0 to 65535)

(5)-5 Mail settings

Enter the settings for emails on the device.

When mail send setting is complete various notification setting (Alarm, low battery, drive low capacity (only during capturing)) is sent. Also, when periodic notification is set, it is sent according to the set time.

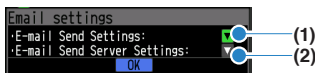

(1) Mail send settings

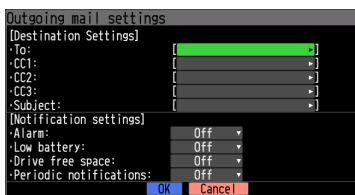

Setting		Description	
Outgoing mail settings	Destination Settings	TO	Set the destination (address) of the E-mail. Enter the string of up to 63 characters.
		CC1 to CC3	Set the destination of the E-mail (broadcast 1 to 3). Enter the string of up to 63 characters.
		Subject	Set the subject of the E-mail. Enter the string of up to 63 characters.
	Notification settings	Alarm	Set the E-mail send when an alarm occurs. Off, On
		Low battery	Set the E-mail send when the internal battery lowers. Off, On
		Drive free space	Set the E-mail send when the drive free capacity during recording is low. Off, On
		Periodic notifications	Set the periodic notification E-mail send. Off, 1 hour, 2 hours, 3 hours, 6 hours, 12 hours, Specified time * You can set the specified time to the hours : minutes : seconds.

(2) Mail send server settings

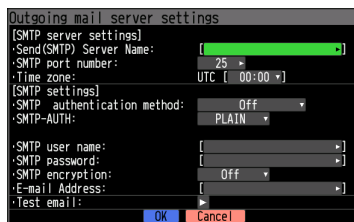

	Setting	Description
Outgoing mail settings	Send (SMTP) Server Name	Set the E-mail Send Server Name (server address). Enter the string of up to 63 characters. * Enter the domain name or IP address. * Enter the server name notified from the mail provider.
	SMTP port number	Set the port number of the E-mail Send Server. 0 to 65535 * Enter the port number notified from the mail provider.
	Time zone	Set the time zone. UTC-12:00 to UTC+13:00 * This is a common setting with time zone setting of POP3 server setting and NTP setting.
	SMTP authentication method	Set authentication method for SMTP-AUTH. PLAIN, LOGIN, CRAM-MD5, DIGEST-MD5
	SMTP-AUTH	Set the SMTP authentication method. Off, POP before SMTP, SMTP-AUTH
	POP3 server settings	You can set this when POP before SMTP is selected in SMTP authentication method. Set the user name to log in to the SMTP server. Enter the string of up to 63 characters.
	SMTP user name	Set the user name to log in to the SMTP server. Enter the string of up to 63 characters.
	SMTP password	Set the password to log in to the SMTP server. Enter the string of up to 63 characters.
	SMTP encryption	Set the encryption of the SMTP server. Off, StartTLS, Over SSL * Set the encryption notified from the mail provider.
	E-mail Address	Set your own E-mail address. Enter the string up to 63 characters.
	Test email	A test E-mail is sent.

(3) < Incoming mail server settings >

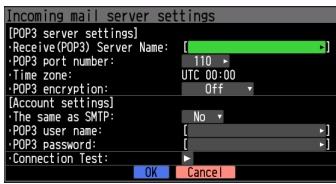

	Setting	Description
Incoming mail server settings	Receive (POP3) Server Name	Set the E-mail Receive Server Name (server address). Enter the string of up to 63 characters. * Enter the domain name or IP address. * Enter the server name notified from the mail provider.
	POP3 port number	Set the port number of the E-mail Receive Server. 0 to 65535 * Enter the port number notified from the mail provider.
	Time zone	Set the time zone. UTC-12:00 to UTC+13:00 * This is a common setting with time zone setting of POP3 server setting and NTP setting.
	POP3 encryption	POP3 encryption Set the encryption of POP3 server. Off, StartTLS, Over SSL * Set the encryption notified from the mail provider.
	The same as SMTP	Set whether to use the same POP3 user name and POP3 password as SMTP user name and SMTP password. No, Yes
	POP3 user name	Set the user name to log in to the POP3 server. Enter the string of up to 63 characters.
	POP3 password	Set the password to log in to the POP3 server. Enter the string of up to 63 characters.

When the authentication of the send (SMTP) server is set to “POP Before SMTP”, you must log in to the POP3 server before accessing the send (SMTP) server.

Set the information to log in to POP3 server to the mail receive server.

However, only login to the receive server is performed and email will not be received.

(5)-6 Identification name

Set the identification name to be used with our application.

The identification name entered here will be displayed as the device name on the device search screen of our application.

(6) OTHER settings

Various other conditions can be set.



Setting		Description	
LCD brightness		Set the brightness of the LCD backlight. Light, Medium, Dark	
Screen Saver		Set the time the screen saver will start up. Off, 10, 30s; 1, 2, 5, 10, 30, 60min	
Power On Start		Set whether to automatically start capturing when the power is turned on. Disable, Enable	
Over voltage protection (Free Running)		Set the overvoltage detection function. Off, On	
TEMP. Settings	Room Temp	Set the room temperature compensation for temperature measurement. Internal, External	
	Temp. Unit	Set the unit of temperature. °C, °F	
Background Color		Set the background color on the screen. Black, White	
Confirm Start/Stop		Set the confirmation message display when starting/stopping capturing. Off, On	
Function key settings		Set the operation of the [FUNC] key.	
	Y-T displayed	Free run	Always select, NAVI, Screen copy, Alarm clear, Pulse integration clear, Internal RAM clear, Auto save cancel
		Recording	Always select, Screen copy, Alarm clear, Pulse integration clear, Immediately back up
		Replaying	Always select, Screen copy, Alarm clear, Pulse integration clear, Search next, Search previous, Cursor synchronization, Auto save cancel
	Logging displayed	Free run	Always select, NAVI, Screen copy, Alarm clear, Pulse integration clear, Internal RAM clear, Statistical operation clear, Auto save cancel
		Recording	Always select, Screen copy, Alarm clear, Pulse integration clear, Immediately back up
	XY displayed	Free run	Always select, NAVI, Screen copy, Alarm clear, Internal RAM clear, XY display clear, Auto save cancel
		Recording	Always select, Screen copy, Alarm clear, Immediately back up
		Replaying	Always select, Screen copy, Alarm clear, Auto save cancel
	Date/Time	Date/Time	
Internet time		Off, On	
Internet time			Set the Internet time (NTP). Off, On
NTP server			Set the time server (NTP server). Enter the character string of up to 127 characters
Time Zone			Set the time zone. UTC-12:00 to UTC+13:00 * This setting is the same as the time zone setting of SMTP server setting and POP3 server setting.
Synchronized Time			Set the time for time synchronization. 0 hour 00 minute to 23 hour 59 minute
Adjust Mode			Set the adjust mode. Immediately, Slowly
Connection Test			Perform a connection test to the time server (NTP server).
Language		Set the display language. Japanese, English (US), English (UK), French, German, Chinese, Korean, Russian, Spanish	
Return to default settings		Return the settings to the default settings.	

Setting	Description
Information	Various version information and MAC address are displayed.
Demo waveform	Set the demo waveform mode. Off, On
NAVI functions	Start up the NAVI functions.

(6)-1 LCD brightness

Set the brightness (three stages of bright, middle, and dark) of the LCD backlight.

(6)-2 Screen Saver

Select the time (eight stages of 10 s to 60 min.) you want to specify. The screen is switch to Off state automatically when the non-operation state continues for a predetermined period.

Turns off the display if not operated for some time to extend the service life of the LCD screen.

If this device runs on a battery pack (B-569, option), the use of this function prolongs the drive time.

(6)-3 Power On Start

Sets the feature which initiates measurement as soon as this device is turned on.

Setting	Description
Disable	Even when turning On the power, the recording starts automatically.
Enable	When turning On the power, the recording does not start automatically.

(6)-4 Overvoltage detection function

Set the function to reduce damage of this device when overvoltage is applied.

Setting	Description
Off	Even if overvoltage is detected, the range is not changed.
ON	In Free Running, when the voltage exceeding the set range is detected, the range is automatically changed to 1000V.

CAUTION

- **This function is effective only during free running.**
This is not effective during capturing and remote (connection to the PC).
- **This function is effective when the set range is in the range of 20mV to 2V.**
This is not effective when the set range is 5V or more.
- **This function is also available for CH set to temperature and humidity.**
When overvoltage is detected in the state in which set to temperature and humidity, the input is changed to voltage input and then changed to the 1000V range.
- **This function is intended to reduce damage from overvoltage, but is not to protect damage. Depending on the input voltage, the input circuit may get damaged, so be careful not to input any overvoltage.**
(For details on overvoltage, refer to "2.12 Precautions to Observe When Performing Measurement".)

(6)-5 Temperature settings

Set the items related to temperature.



Room temperature compensation

Set whether thermocouple room temperature (terminal temperature) compensation of this device is used or not.

Setting	Description
Internal	Room temperature compensation of this device is enabled. (Normally you should select this.)
External	Set it when compensating for room temperature with external equipment.

Temperature unit

Switch between °C (Celsius) and °F (Fahrenheit) units when setting the temperature.

°F (Fahrenheit) is calculated by the following formula.

$$^{\circ}\text{F (Fahrenheit)} = ^{\circ}\text{C (Celsius)} \times 1.8 + 32$$

When checking accuracy, calculate with Celsius accuracy x 1.8.

(6)-6 Background Color

Set the background colors of the waveform display area and the digital display area.

(6)-7 Start/Stop confirmation message

Set whether to display the confirmation message at start/stop.

Setting	Description
Off	Confirmation message is not displayed when starting/stopping.
On	Confirmation message is displayed when starting/stopping.

(6)-8 FUNC key settings

Set the behavior when the function key is pressed.

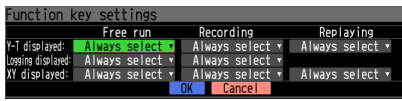

[FUNC] key can be set according to each screen mode (Y-T/logging/XY) and operating status (free running/capturing/replaying) respectively.

By pressing the [FUNC] key, the setting contents are executed immediately.

The contents that can be set in each status are listed below. The "○" mark in the table indicates that setting is possible.

Setting items		Free Run	Recording	Replaying
X-T	NAVI	○	×	×
	Screen copy	○	○	○
	Alarm clear	○	○	○
	Pulse operation clear	○	○	○
	Internal RAM clear	○	×	×
	Next search	×	×	○
	Prev. search	×	×	○
	Cursor synchronization	×	×	○
	Auto save cancel (only when saving automatically)	○	×	○
	Immediately back up (only when backup is set to On)	×	○	×
Logger	NAVI	○	×	No status
	Screen copy	○	○	No status
	Alarm clear	○	○	No status
	Pulse operation clear	○	○	No status
	Internal RAM clear	○	×	No status
	Statistical operation clear	○	×	No status
	Auto save cancel (only when saving automatically)	○	×	No status
	Immediately back up (only when backup is set to On)	×	○	No status
XY	NAVI	○	×	×
	Screen copy	○	○	○
	Alarm clear	○	○	○
	Internal RAM clear	○	×	×
	XY display clear	○	×	×
	Auto save cancel (only when saving automatically)	○	×	○
	Immediately back up (only when backup is set to On)	×	○	×

When "Always select" is set, items marked with "○" are displayed according to the status when pressing the [FUNC] key.

Use the the ▲▼ keys to select the item you want to perform.

Press the [ENTER] key to perform the content you select.

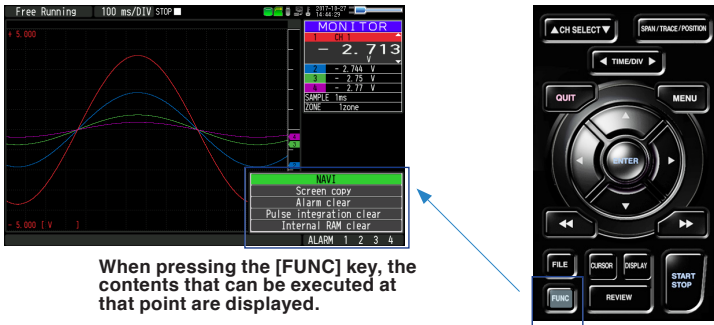

When pressing the [FUNC] key, the contents that can be executed at that point are displayed.

(6)-9 Date/Time

This is the setting related to the device clock.

The internal clock (date and time) of the device can be manually set. Alternatively, if the Network Time setting is used, the clock can be automatically adjusted via the NTP network. Refer to the next section, "Network Time Setting" for details.

Network time

The device has a function to synchronize with time of clock server via Ethernet.

Using this function, set the Network time.

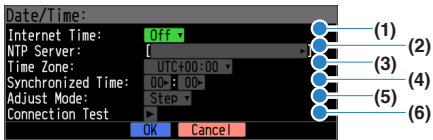

Setting	Description
(1) Internet Time	Set whether to use this function or not. Off: This function is not used. Time adjustment is not performed. On: Use this function to adjust the time.
(2) NTP Server	Enter the domain name (or IP address) of the time server (NTP server) to be used.
(3) Time Zone	Set the time zone in the area where this device is used. (Japan: +0900) * This setting is the same as the time zone setting of SMTP server setting and POP3 server setting.
(4) Synchronized Time	Set the time to synchronize with the server. When the set time comes, the time synchronization operation is performed by the method set in the synchronous mode.
(5) Adjust Mode	Set the method to synchronize to the time server. Immediately: When the synchronization time comes, this device is immediately adjusted to the time of the time server. Slowly: Even if the synchronization time comes, this device is not synchronized immediately. This device gradually synchronizes with the time of the time server. The adjustment is approx. 43 seconds per day. (Adjustment of approx.10 ms in 20 seconds.)
(6) Connection Test	Perform a connection test to the time server (NTP server).

CAUTION

Synchronization is not performed if the time difference with the time server is 500 ms or less.

(6)-10 Language

Set the display language (9 languages of Japanese, English (US), English (UK), French, German, Chinese, Korean, Spanish and Russian).

In addition, when this setting is changed, "CSV decimal point" and "CSV delimiter" of the CSV file are initialized.

Language	CSV decimal point	CSV delimiter
Japanese	Period (.)	Comma (,)
English(US)	Period (.)	Comma (,)
English(UK)	Period (.)	Comma (,)
French	Comma (,)	Semicolon (;)
German	Comma (,)	Semicolon (;)
Korean	Period (.)	Comma (,)
Chinese	Period (.)	Comma (,)
Russian	Comma (,)	Semicolon (;)
Spanish	Comma (,)	Semicolon (;)

(6)-11 Return to default settings

Returns all the settings to the factory defaults. When initialized, setting conditions returns to the factory default settings.

(6)-12 Information

The system information is displayed.

(6)-13 Demo Waveform Mode

This parameter displays demo waveforms without inputting analog signal.

Setting	Description
Off	The demo waveform is not displayed.
On	The demo waveform is displayed.

(6)-14 NAVI function

Operate the screen display procedure to perform capturing and trigger settings.

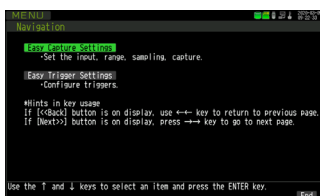

Setting	Description
Easy capture setting	Conditions (input, range, sampling and capturing destination, etc.) for data measurement and data recording can be set in accordance with the instructions displayed on the screen.
Easy trigger setting	The settings (trigger) for data capture can be set in accordance with the instructions displayed on the screen.

Set this by following the instructions displayed on the menu.

(7) FILE menu

The operations for file can be performed by pressing the [FILE] key.

The displayed items vary depending on Backup Off/On or Auto save or XY screen.

< Normal >

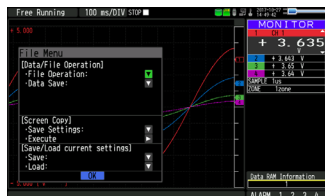

< Backup On >

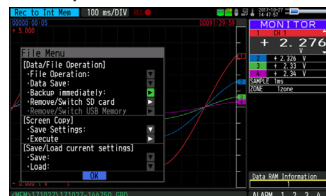

< Auto save >

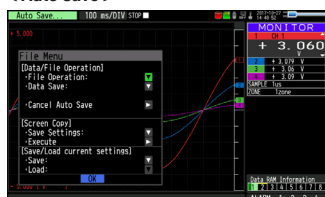

< XY screen >



(7)-1 File Operation

On this screen, you can operate files from the internal memory, SD card or USB memory.

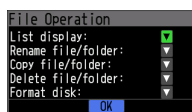

Operation mode	Operations
List display	The detailed file and folder information (file name, date, and time) are displayed.
Rename file/folder	Change the file name or folder name. The name can be changed by selecting the recorded file or folder.
Copy file/folder	Copy the file or folder. Select the recorded file or folder (Multiple files/folders can be selected) you want to copy, and then select the copy destination (another folder, etc.), operate the Select/Execute of the copy destination.
Delete file/folder	Delete the file or folder. Select the recorded file or folder (Multiple files/folders can be selected) you want to delete and then operate the Delete Execute.
Format disk	Initialize the internal memory, SD card or USB memory.

<Example of operation procedure>

Example of file/folder delete procedure is described.

(1) Select the file/folder you want to delete.



Move the cursor to the file or folder you want to delete and then press the [ENTER] key. The "v" mark is displayed in the checkbox. (Multiple files/folders can be selected)

Press the [ENTER] key again to cancel.

When this is cancelled, the "v" mark will disappear.

The selection is completed by pressing the [QUIT] key.

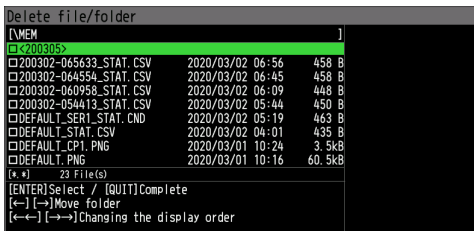

(2) Enable the deletion.

The message of “Delete the file. All data will be lost. Are you sure?” is displayed.

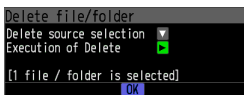

The files are deleted by operating the [ENTER] key again.

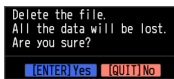

(7)-2 Data Save

Data in the internal RAM can be saved as well.

During data replay, you can save the data that is being replayed.

When saving in internal RAM

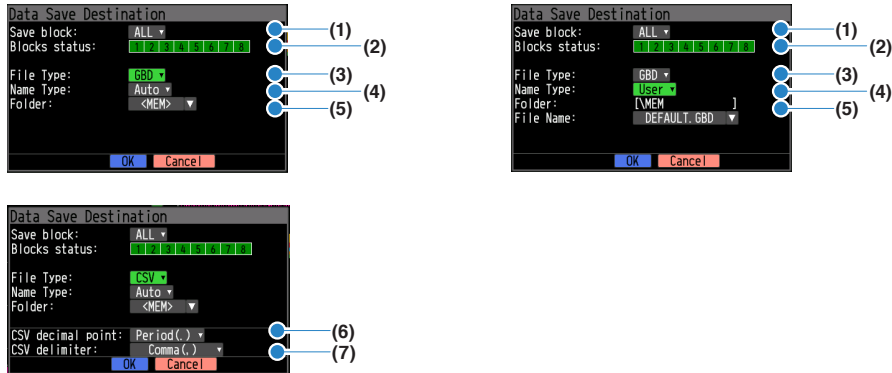

Setting	Description
(1) Save block	Select the internal RAM block to be saved. 1 to 8, ALL Numbers vary depending on the number of block divisions. When ALL is selected, the block in which all the data exists is saved.
(2) Blocks status	The status of the internal RAM is displayed.
(3) File Type	Set the file format of data. GBD: The data file is created in our own binary format. * Data cannot be changed. CSV: The data file is created in text format.
(4) Name Type	Set the naming method for the data file. Auto: File name is appended automatically. Example) 20170201-123456.GBD Numbers part Date and time when the file was created * Example: 2017 year 2 month 1 day 12 hour 34 minute 56 second GBD Data format GBD (binary data) CSV (text format) Arbitrary: Data is captured with the file name you entered. Serial number: File is created by indexing a serial number to the arbitrarily entered file name.
[Auto]	(5) Folder Set the folder of the save destination.
[Arbitrary] [Serial number]	(5) Folder File Set the file name of the data. The folder for saving the file is displayed in the Folder.
(6) CSV decimal point	Set the decimal point character of the CSV file. Period (.), Comma (,)
(7) CSV delimiter	Set the delimiter of the CSV file. Comma (,), Tab (Tab), Semicolon (;)

During data replaying

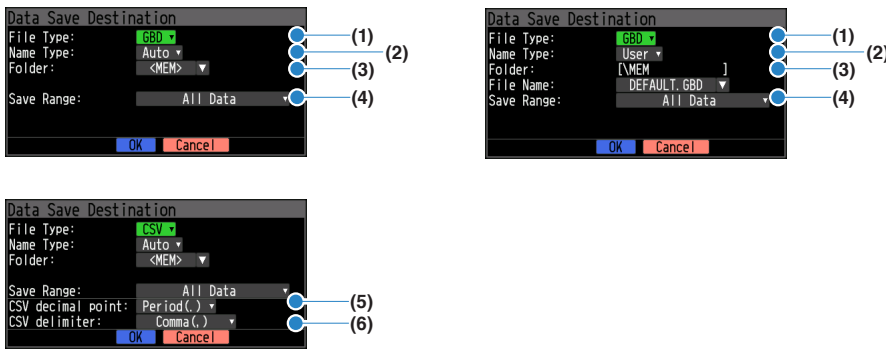

Setting	Description
(1) File Type	Set the file format of data. GBD: The data file is created in our Graphtec's binary format. * Data cannot be changed. CSV: The data file is created in text format. * While GBD file is being replayed, you can duplicate it to a GBD file and convert it to a CSV file. * While CSV file is being replayed, you can copy to CSV file, but conversion to GBD file cannot be performed.
(2) Name Type	Set the naming method for the data file. Auto: File name is appended automatically. Example) 20170201-123456.GBD Numbers part Date and time when the file was created * Example: 2017 year 2 month 1 day 12 hour 34 minute 56 second GBD Data format GBD (binary data) CSV (text format) Arbitrary: Data is captured with the file name you entered. Serial number: File is created by appending a Serial number to the arbitrarily entered file name.
[Auto]	(3) Folder Set the folder of the save destination.
[Arbitrary] [Serial number]	(3) Folder File Set the data file name. The folder for saving the file is displayed in the Folder.
(4) Save Range	Set the range of data to be saved. All Data: All the data is saved regardless of the cursor. Data between cursors: Data of the range between A and B cursors is saved.
(5) CSV decimal point	Set the decimal point character of the CSV file. Period (.), Comma (,)
(6) CSV delimiter	Set the delimiter of the CSV file. Comma (,), Tab, Semicolon (;)

(7)-3 Immediate backup

Perform backup processing immediately.

During the recording, you can use this function when backup setting is set to On.

Select the Immediate Backup and press [ENTER] key to perform the backup process immediately regardless of the backup interval set in the backup setting.

* Back up data that has not been backed up yet is backed up.

* If the amount of data to be backed up increases by combining the sampling interval and backup interval, it may take time to perform the backup process.

(7)-4 Remove/replace SD card/USB memory

The SD card/USB memory can be not swapped during data back up.
 Perform the card replacement according to the following procedure.

- (1) Press the [FILE] key to open the FILE menu.
- (2) Press [ENTER] key to perform "Remove/replace SD card/USB memory."

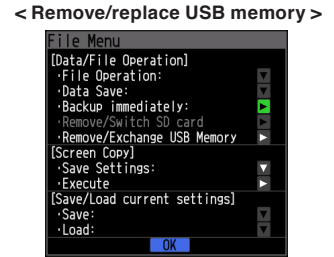
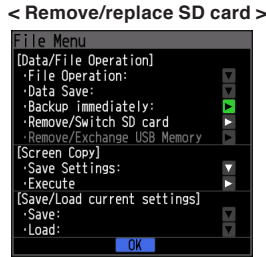
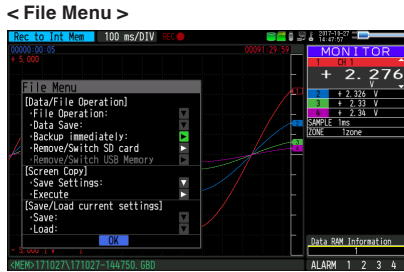

- (3) Make sure that the message is displayed and then remove the SD card/USB memory.

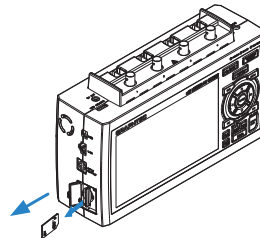
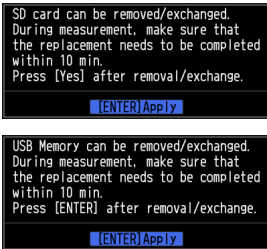

When SD card is attached

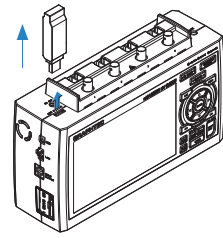

When USB memory is attached

CAUTION

Do not remove the SD card/USB memory until the remove/replace message is displayed.
 Data may become corrupt and inaccessible.

- (4) Insert the new SD card/USB memory.

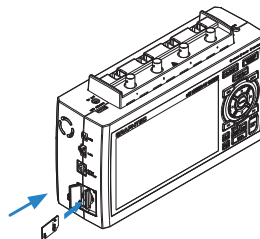
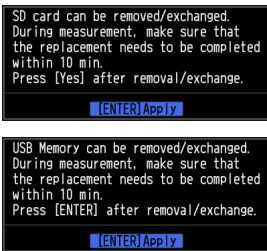

When SD card is attached

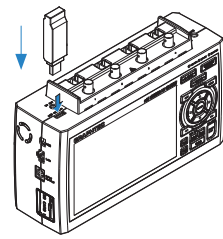

When USB memory is attached

- (5) Make sure that the device access indicator turns green and then press [ENTER] key. For access to device access indicator, refer to "3.1 Window names and functions".

CAUTION

Please perform the memory replacement within the displayed time in the message. If the displayed time passes, data will be erased.

CHECKPOINT

Each time the SD card/USB memory is replaced, the _CHG number is added to the backup file name.

Example : When backing up with backup file name " TEST".

1st SD card/USB memory: TEST_BAK2.GBD

2nd SD card/USB memory: TEST_BAK2_CHG1.GBD

(7)-5 Cancel auto save

Auto save process can be cancelled when the recording destination is set to internal RAM and Auto save is performed.

Select "Cancel auto save" and press [ENTER] key to cancel the auto save process.

(7)-6 XY overwrite

Perform XY overwrite settings.

You can select it when XY screen is displayed.



Setting	Description
(1) Select File	Select the image file to be XY-overwritten and perform XY overwrite. The image file is a screen copy of the file menu being XY-displayed, and the storage range is the image file saved as the waveform screen.
(2) Overwrite clear	Erase the XY overwritten image and finish the XY overwrite.

For details, refer to "3.5 Setting Menus" - "(3) DISP settings" - "(3)-3 XY display" - "XY overwrite".

(7)-7 Screen copy

Save the copy image of the display screen in the internal memory/SD card/USB memory.

Specify save destination

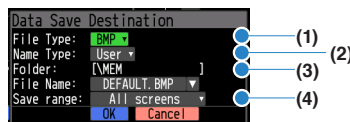
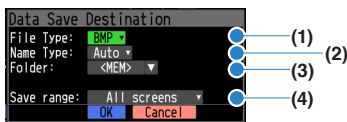

Setting	Description
(1) File Type	Set the file format of image data. BMP: Image data is created in BMP format. PNG: Image data is created in PNG format.
(2) Name Type	Set the naming method for the data file. Auto: File name is appended automatically. Example) 20170201-123456.GBD Numbers part Date and time when the file was created * Example: 2017 year 2 month 1 day 12 hour 34 minute 56 second BMP Data format BMP (BMP format) PNG (PNG format) Arbitrary: Data is saved with the file name you entered. Serial number: Image data file is created by appending a serial number to the arbitrarily entered file name.
[Auto]	(3) Folder Set the folder of the save destination.
[Arbitrary] [Serial number]	(3) Folder File Set the data file name. The folder for saving the file is displayed in the Folder.
(4) Save range	Set the range of the image data to be saved. All screens: The entire screen is saved as image data. Waveform screen: Only the waveform display part is saved as image data.

Execution

Execute the screen copy to save the image data file in the saving destination set in "Specify save destination".

(7)-9 File selection/Operation tool

This tool is used for file selection and operation such as list display of file menu and data save destination on the DATA menu.

The operation method is as follows.

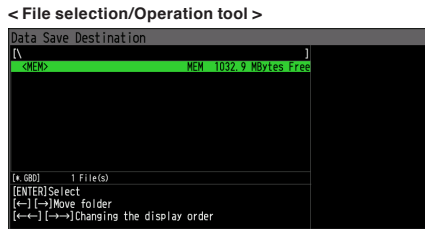

Key	Description
◀ ▶	Moves between folders. ◀ : Move up one folder. ▶ : Move down one folder.
◀◀ ▶▶	The display order can be changed.
ENTER	Finalize the operation.
QUIT	Close the file selection/operation tool. (The selection is confirmed in the copy and delete operation.)

Create new folder

To create a new folder, move to the folder where you want to create the folder, select [Create new folder], and then press [ENTER] key.

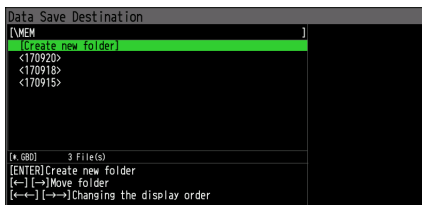

The character string input tool starts up. Enter a folder name.

After confirming the folder name, a folder is created.

Thumbnail display

If there is a waveform screen data saved automatically when data is captured by this device, the waveform screen data is displayed as a thumbnail when files are listed.

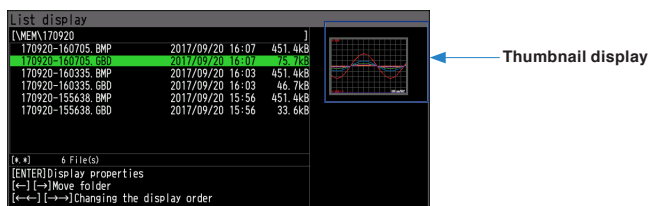

If there is a BMP file with the same file name as the data file, the thumbnail is displayed. (The image data for thumbnail saved by this device are only supported.)

< Saving thumbnail images when data is captured >

When the data recording destination is the internal memory/SD card/USB memory, the screen copy of the waveform screen displayed at the end of data capturing with the same file name as the data file is performed.

When the recording destination is internal RAM, thumbnail files are not created.

In addition, as part of the ending process of the data capture, a copy of the waveform screen that is displayed on the screen at this point is created. Therefore, depending on the sampling interval and Time/DIV setting, it may not match the last waveform of the data file.

(7)-10 Character string enter tool

The tool is used to enter the character string such as folder name, file name, annotation character string, and unit of EU (scaling), etc.

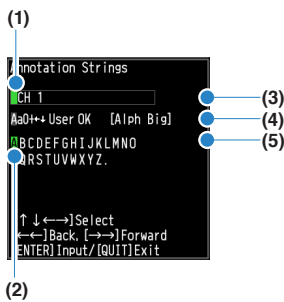

Display Item	Operation	Description	
(1) Character string selection cursor		This is the cursor that indicates the position to edit the character string you enter.	
(2) Input selection cursor		This is the cursor to select the input operation.	
(3) Character string entry field		An input character string is displayed. The character string cursor is shown in the character to be edited.	
(4) Operation selection		Move the input selection cursor, select, insert, delete and confirm the type of characters you enter.	
	A	Upper case alphabet mode	This mode is for entering upper case alphabets.
	a	Lower case alphabet mode	This mode is for entering lower case alphabets.
	0	Numeric mode	This mode is for entering numbers.
	ア	Half-width Kana mode	This mode is for entering half-width Kana. (only available when Japanese setting is used)
	+	Symbol mode	This mode is for entering symbols.
	←	One character delete	One character on the character string selection cursor is deleted.
	↓	One character insert	One character space is inserted on the character string selection cursor.
	User	User defined character string mode	Enter the user defined character string.
	OK	Confirm	Confirm the edited character string and close the tool.
(5) Character selection	Input character of each mode	Move the input selection cursor and select the input character.	

< Moving character string cursor >

(1) Use the ◀◀ and ▶▶ keys to move the cursor.

< Operation selection (selection of character type) >

(1) Press the ▲ key several times to move the enter selection cursor to the operation selection line.

(2) Use the ◀ and ▶ keys to select the operation (character type).



< Enter character selection >

- (1) Select the character type to be entered in operation selection.
- (2) Use the ▼ key to move the enter selection cursor to the character selection field.
- (3) Use the ▼ , ▲ , ◀ , ▶ keys to move the enter selection cursor to the character you want to enter.
- (4) Use [ENTER] key to enter a single character.

The entered character is overwritten by the character string cursor and the character string cursor moves one character to the right.

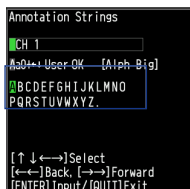

< Confirmation of entered character string >

- (1) Press the ▲ key several times to move the enter selection cursor to the operation selection line.
- (2) Select [OK] with the ◀ ▶ keys and confirm it with [ENTER] key.

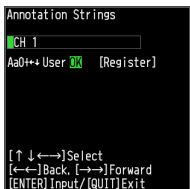

< User character string enter >

- (1) Select "User" in operation selection.
- (2) Use the ▼ ▲ keys to move to the user character string you want to enter.
- (3) Enter the user character string with [ENTER] key.

In the enter user character string, the character string from the character string cursor is overwritten. The character string cursor moves one character to the right from the overwritten character string.

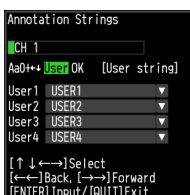

< User character string change >

- (1) Select "User" in operation selection.
- (2) Use the ▼ ▲ keys to move to the user character string you want to change.
- (3) Select "▼" by pressing ► key.
- (3) Press [ENTER] key to display the character string enter tool for user character string editing.
There is no user string in this tool.
- (4) After editing the user character string, confirm the character string.

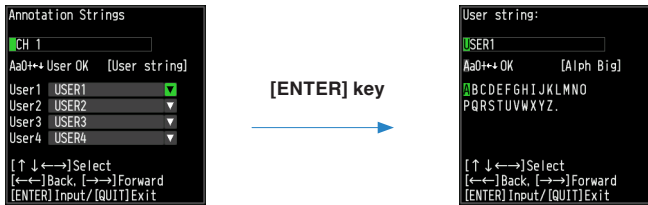

(8) Data replay menu

Select the data you want to replay from the “Data replay source” by pressing the [REVIEW] key and replay the captured data.

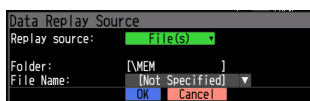
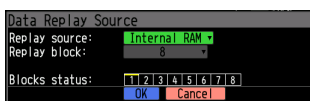

Press [MENU] key during replaying to display the data replaying menu.

< Y-T replay >

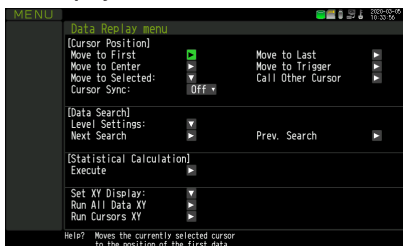

< XY replay >

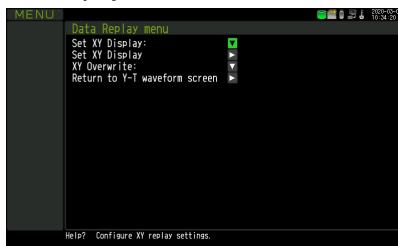

Y-T replay

Setting		Description	
Cursor Position	Move to First	Move the selection cursor to the top of the data.	
	Move to Last	Move the selection cursor to the end of the data.	
	Move to Center	Move the selection cursor to the middle position of the data.	
	Move to Trigger	Move the selection cursor to the position where the trigger occurred.	
	Move to Selected	Selection method	
		[Position]	Moving position
		[Time]	Moved date/time
Call Other Cursor	Move the other cursor to the position of the currently selected cursor.		
Cursor Sync	Set the synchronous movement of the cursor. Off, On		
Data Search	Combination	Set a combination of search conditions. Edge OR, Edge AND	
	Mode	[Analog CH]	Off, Rising, Falling, Window In, Window Out
		[Logic CH]	Off, H, L * Logic CH is used for pattern comparison of all the logic CH.
		[Pulse CH]	Off, Rising, Falling, Window In, Window Out
		[Alarm]	Off, Output 1, Output 2, Output 3, Output 4
	Level settings	Enter the search level as a numerical value. If it is within the range/out of range, you should set two places.	
Next Search	Search the next (future) position matching the search condition from the current cursor position.		
Prev. Search	Search the previous (future) position matching the search condition from the current cursor position.		
Statistical Calculation	Execute the statistical calculation between cursors.		
Set XY Display	Perform the settings for XY display.		
CH	CH	Set X-axis and Y-axis of XY graph. CH1 to CH4	
	Trace	Set the trace of XY graph. Off, On Waveforms are not displayed on the screen when the trace is set to Off. Also it is not displayed on the digital display.	
	Position	Set the XY position. 0 to 100%	
	Vernier	Set the XY Vernier. 40 to 100% * The range varies depending on the range setting.	

Setting		Description
	Span	Set the Span. You can set it when the analog CH in the Span mode is set to the axis.
Run All Data XY		Execute XY display for all data. * When the amount of data is large, it may take time to draw XY graph.
Run Cursors XY		The data of the section sandwiched between cursors AB is XY-displayed. * When the amount of data is large, it may take time to draw the XY graph.

XY replay

Setting		Description
Set XY Display		Perform settings for XY display.
	CH	Set X-axis and Y-axis of XY graph. CH1 to CH4
	Trace	Set the trace of XY graph. Off, On Waveforms are not displayed on the screen when trace is set to Off. They are also not displayed on the digital display.
	Position	Set the XY position. 0 to 100%
	Vernier	Set the XY Vernier. 40 to 100% * The range varies depending on the range setting.
	Span	Set the Span. You can set it when the analog CH in the Span mode is set on the axis.
Reflect XY display settings		The XY graph with the contents of XY display settings is redrawn. * When the amount of data is large, it may take time to draw.
XY Overwrite		Set the XY overwrite.
	Select File	Select the image file to be overwritten and execute overwriting.
	Overwrite clear	The XY overwrite is cleared and completed.
Return to Y-T waveform screen		The data being replayed is changed to Y-T display.

(8)-1 Move to selected position

Set the position (relative time with the trigger point set as 0) or the time and then move the current selected cursor (A or B) to the position.

< Position >

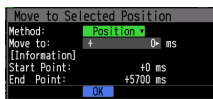

< Time >

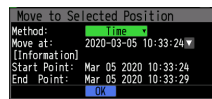

(8)-2 Cursor synchronization

Set function that move two cursors in synchronization.

Setting	Description
Off	Cursors are not synchronized. Only the specified one cursor moves.
On	Two cursors move in synchronization.

* Cursor Synch is turned Off when you move a cursor using the Move to Selected Position or perform Data Search.

(8)-3 Data search

Set the conditions for data search.

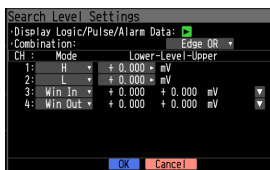

For details of the Combination and Mode and Level, refer to "3.5 Setting Menus" - "(4) TRIG settings" - "Trigger level settings/Alarm level settings".

Alarm CH is searched when the specified alarm output turns On.

After setting the search conditions, perform a search by selecting "Search for next" and "Find previous".

(8)-4 Statistical calculation between cursors

Perform the statistical calculation between cursors.

The statistical calculation of the section between the cursors A and B is performed.

As soon as the calculation process is completed, the result is displayed.

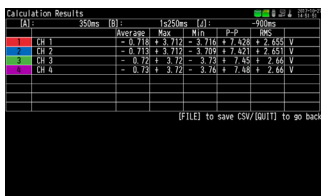

Setting	Description
Average	Displays the simple average value between cursors.
Max	Displays the maximum value between cursors.
Min	Displays the minimum value between cursors.
Peak	Displays the peak value between cursors.
RMS	Displays the RMS value between cursors. The calculation formula is as follows: $R.M.S = \sqrt{\sum D^2/n}$ * D: data n: number of data

Press the [FILE] key during displaying the result to save the calculation result in CSV format.

* The specifying method of storage location and file name is the same as the file specifying method of captured data.

(8)-5 XY display settings

Perform XY display setting when starting XY execution.

For details, refer to "3.5 Setting Menus" - "(3) DISP settings" - "3 XY display". This is a common setting.

You can set it again during XY replaying.

(8)-6 XY Execution

Perform XY display according to the XY display settings.

All data XY execution: XY display is executed for all data that is being replayed.

XY execution between cursors: XY display is executed for data between cursors A and B.

* When the amount of data is large, it may take time to draw the waveform of XY display.

(8)-7 Reflecting XY display

When XY display setting is changed during XY replaying, XY waveform is redrawn for reflection from the XY display setting.

* When the amount of data is large, it may take time to draw the waveform of the XY display.

(8)-8 XY overwrite

Perform XY overwrite settings.

For details, refer to "3.5 Setting Menus" - "(3) DISP settings" - "3 XY display" - "XY overwrite ". This is a common setting.

(8)-9 Change to Y-T display

Perform Y-T display with data that is being executed currently in XY display.

3.6 WEB Server Function

This function allows operating and monitoring the device via a Web browser.

- Supported Web browsers
 - Microsoft Internet Explorer 11 or later
 - Firefox 1.5 or later
- Available functions using a Web browser
 - Operating this device
 - Monitoring this device's display screen
 - Enlarging this device's display screen
 - Linking to FTP
 - Linking to our Web site
- Setting the URL

The URL (Uniform Resource Locator) must be correctly set according to your network environment.

When the port number is changed, enter the following:

http://(IPAddress): (port number)/index.html

 - http Protocol to access the server.
 - HTTP (Hyper Text Transfer Protocol)
 - IP address Enter the IP address of this device to be monitored.
 - Port number Specify the port number.
 - The port number is the number set to this device or the router, etc.
 - Index.html This is the file name. This file name is fixed to index.html.

CHECKPOINT

- **The port number can be omitted. In this case, the port number is 80.**
 - http://(IPAddress): 80/index.html
- **It is not possible to simultaneously connect to the web server from multiple browsers. Please use a single browser for one device.**

Procedure

1. Open the Web browser.

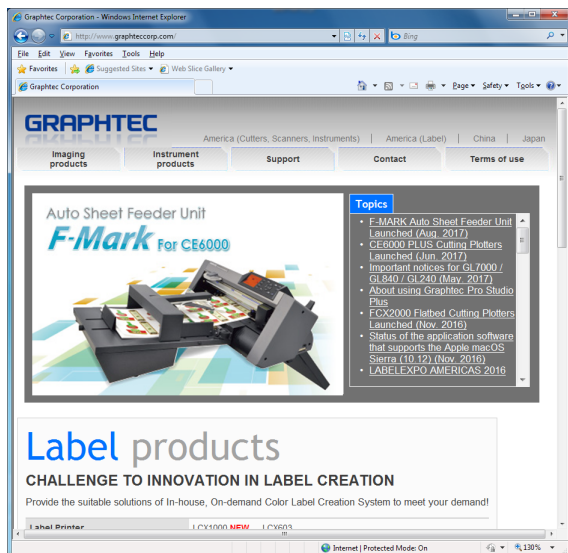

2. Enter the URL (http://IPaddress/index.html) in the address.

3. The following screen is displayed.

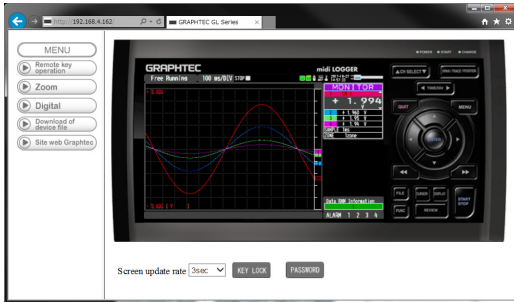

Remote key operation..... This device can be remotely operated.

Screen display The screen of this device is displayed large. You can easily operate this device.

Digital display..... Measured value is displayed digitally.

Downloading files in this device... Data captured in this device can be downloaded to the PC using the FTP function.

Graphtec's homepage Links to our homepage.

Remote operation

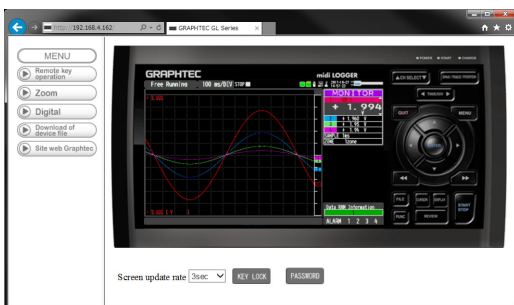

KEY LOCK Sets and cancels key lock.

PASSWORD Sets and cancels a password.

Screen update rate Sets an update rate of the screen.

The screen update rate can be set either to 2, 3, 5, 10 seconds.

Click the key displayed on this device to control remotely this device.

Screen display



KEY LOCK Sets and cancels key lock.

PASSWORD Sets and cancels a password.

Screen update rate Sets an update rate of the screen.

The screen update rate can be set either to 2, 3, 5, 10 seconds.

This operation is the same as remote operation, but the screen is displayed in four times larger.

Digital display

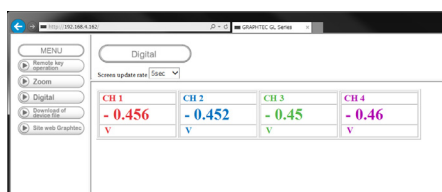

Screen update speed Specifies the speed in which the screen is updated.

Available update speeds are 3, 5, 10, 20, 30 seconds, 1, 5, 10, 20, 30 minutes, 1 hour

<FTP server functions>

When connecting with FTP server using the Internet Explorer, login is automatically performed using an anonymous account and the files become read-only files.

The following operations cannot be performed for read-only files:

- Upload file
- Delete file/folder
- Create file/folder
- Change file name/folder name

To write the the data to this device, the login account name must be changed.

Please use the following table as a guide.

Account name	Password	Restrictions
GL2000	None	None
gl2000	None	None
Anonymous	Any	Read-only

The account cannot be changed in Internet Explorer.

Please use FTP application which can set the account separately.

3.7 List of Error Codes

If an error code is displayed on this device, please handle errors in reference to the table below.

Error code	Description
-1	Unexpected error
1	Please contact us.
2	File not found. The operation target is not a folder.
3	Hardware error There is a possibility that the hardware has failed. Please contact us.
5	The Internal memory, SD card, or USB memory may be failed.
8	Please contact us.
9	Please contact us.
12	Please contact us.
13	Light Protected state. Please check the write-protect switch of the SD card.
16	Please contact us.
17	File/folder already exists. The error code is displayed when you created a folder with the folder name that already exists.
21	The target is not a file. You tried to perform the file operation for a folder.
22	The path name is too long.
23	Please contact us.
24	Please contact us.
27	Please contact us.
28	Please contact us.
46	Please contact us.
88	The disc format is not supported.
90	The target directory is not empty.
100	Please contact us.
101	Please contact us.
102	Please contact us.

CHAPTER 4 Specification

This chapter describes the basic specifications for this device.

PRODUCT SUMMARY

- 4.1 *Standard Specifications***
- 4.2 *Function Specifications***
- 4.3 *Accessories/Optional Accessories***
- 4.4 *External Dimensions***

4.1 Standard Specifications

Item	Description	
Number of analog CHs	4CH fixed	
External output terminal	Trigger input (1ch) or external sampling (1ch) Logic input (4ch) or pulse input (4ch) Alarm output (4ch) or trigger output (1ch) + alarm output (3ch) * Trigger input and external sampling input can be switched. * Alarm output and trigger output can be switched.	
PC I/F	Ethernet (10BASE-T/100BASE-TX) USB (compatible with high-speed) standard-included	
Internal memory device	Internal RAM : 4MW/CH Internal memory : Approx. 4GB Flash SD card slot : 1* (Compatible with SDHC, up to approx. 32GByte memory available) USB memory slot : 1* (compatible with high-speed, up to 32GByte memory can be used)	
Data backup functions	Setting conditions: EEPROM/Clock: Lithium secondary battery	
Clock accuracy (23°C environment)	Network time setting Off: $\pm 0.002\%$ (monthly difference of approx. 50 seconds) Network time setting On: $\pm 0.01\%$ (day difference about 8.6 seconds) (Maximum error after synchronization)	
Operating environment	0 to 40°C, 5 to 85% RH (15 to 35°C when battery is used)	
Power supply	<ul style="list-style-type: none"> AC adapter : 100 to 240 VAC, 50 to 60 Hz DC input : 8.5 to 24 VDC (Max 26.4V) Battery pack (option) : 7.2 VDC (2900 mAh), two packs can be mounted 	
Power consumption		
• AC power consumption (when using the AC adapter provided as a standard accessory)		
AC100V	Normal	During recharging battery
When the LCD is on	28VA	42VA
When the screen saver is operating	24VA	39VA
AC240V	Normal	During recharging battery
When the LCD is on	39VA	59VA
When the screen saver is operating	34VA	55VA
• DC power consumption		
+24V	Normal	During recharging battery
When the LCD is on	0.50A	0.81A
When the screen saver is operating	0.43A	0.76A
+12V	Normal	During recharging battery
When the LCD is on	1.00A	Recharging not possible
When the screen saver is operating	0.85A	Recharging not possible
+8.5V	Normal	During recharging battery
When the LCD is on	1.46A	Recharging not possible
When the screen saver is operating	1.22A	Recharging not possible
* Normal condition: LCD brightness is set to MAX.		
External dimensions (approximate)	260(W)×161(H)×83(D) mm	
Weight (approximate) *1	1.7 kg	
Vibration proof	Automobile parts Type 1 Class A equivalent	

*1: AC adapter, battery are not included.

Internal RAM

Item	Description
Memory capacity	4MW/CH volatile memory
Memory contents	Measured data
Sampling interval	1, 2, 5, 10, 20, 50, 100, 200, 500 μ s 1, 2, 5, 10, 20, 50, 100, 200, 500 ms 1, 2, 5, 10, 20, 30s, 1min, External
Capturing settings	Set the number of capturing points Setting range: 10 to 4000000 points Input increment: 1 point increment
Pre-trigger	1 to 4000000 points (Points designation and Time display available)
Auto-save function	ON/OFF setting ON: Auto save to internal memory or USB memory OFF: Only temporary save in Internal RAM (When the power is turned off, data is erased.)
Memory division	Settable from 4MW x 1, 2MW x 2, 1MW x 4, 0.5MW x 8 divisions. (Overwrite ON/OFF setting available)

Internal memory

Item	Description
Memory capacity	Approx. 4GByte Flash memory * Up to 4GB for 1 file
Memory contents	Setting condition for this device Measured data, Screen bitmap
Sampling interval	Fastest 1 ms/4CH (when using GBD/CSV) 1, 2, 5, 10, 20, 50, 100, 200, 500 ms 1, 2, 5, 10, 20, 30s, 1min, External

USB Memory slot

Item	Description
Memory capacity	Up to 32GByte memory can be used (however, up to 4GB for 1 file)
Memory contents	Setting condition for this device Measured data, Screen bitmap
Sampling interval	Fastest 1 ms/4CH (when using GBD/CSV) 1, 2, 5, 10, 20, 50, 100, 200, 500 ms 1, 2, 5, 10, 20, 30s, 1min, External

SD card

Item	Description
Memory capacity	SDHC-compatible, up to 32GByte memory can be used. * Up to 4GB for 1 file
Memory contents	Setting condition for this device Measured data, Screen bitmap
Sampling interval	Fastest 1 ms/4CH (when using GBD/CSV) 1, 2, 5, 10, 20, 50, 100, 200, 500 ms 1, 2, 5, 10, 20, 30s, 1min, External

PC I/F

Item	Description
Interface types	Ethernet (10BASE-T/100BASE-TX) USB 2.0
Functions	Data transfer to the PC (realtime, memory) PC control of this device
Ethernet functions (10BASE-T/100BASE-TX)	Web server functions: Displays the screen images FTP server function: Transfer/delete files in Internal memory and SD card FTP client function: Correct time of main unit's clock DHCP client function: IP address automatic acquisition function Email sending function: Email sending (no receiving function)
USB functions	USB drive mode: Transfer/delete the files in internal memory or SD card
Real time data transfer speed	Fastest 1 msec.

Monitor

Item	Description
Display	7-inch TFT color LCD (WVGA: 800 x 480 dots)
Displayed languages	Japanese, English, French, German, Chinese, Korean, Russian, Spanish
Backlight life	50,000 hrs (when brightness is down to 50%), depends on operation environment
Backlight	Screen saver function provided (10, 30 sec., 1, 2, 5, 10, 30, 60 min.)

Input section

Item	Description																																																		
Number of input channels	4CH fixed																																																		
Input terminal type	Voltage	Insulated BNC connector or M3.5 screw terminal unit (However, it cannot input to the BNC connector of same CH and the screw terminal at the same time.)																																																	
	Temperature	M3.5 screw type terminals (Rectangular flat washer)																																																	
Input method	All CH insulation, unbalanced input, all CH simultaneous sampling																																																		
Fastest Sampling interval	1 μ s																																																		
Measurement ranges	Voltage	20, 50, 100, 200, 500 mV; 1, 2, 5, 10, 20, 50, 100, 200, 500, 1000 V (Measurable voltage maximum 600V); 1-5 V F.S.																																																	
	Temperature	Thermocouples : K, J, E, T, R, S, B, N, W (WRe5-26)																																																	
	Humidity	0 to 100% (Voltage 0 to 1V scaling conversion) * B-530 (option) used																																																	
	Root mean square value	10, 25, 50, 100, 250, 500 mVrms 1, 2.5, 5, 10, 25, 50, 100, 250, 500, 1000 Vrms (Measurable voltage maximum 600Vms) F.S. * Crest Factor 2 or less (1000Vms range is 1.4 or less) * Measurable frequency: 20 to 10 kHz * The true effective value (RMS) of AC + DC is measured * The function to automatically obtain the effective value (RMS) and the operation cross value from the currently measured value is provided																																																	
Measurement accuracy (23°C \pm 5°C)	<ul style="list-style-type: none"> • Voltage \pm0.25% of F.S. • Thermocouple <table border="1"> <thead> <tr> <th>Thermocouple</th> <th>Measurement Temperature Range (°C)</th> <th>Measurement Accuracy</th> </tr> </thead> <tbody> <tr> <td rowspan="4">R/S</td> <td>0 \leq TS \leq 100°C</td> <td>\pm7.0°C</td> </tr> <tr> <td>100 < TS \leq 300°C</td> <td>\pm5.0°C</td> </tr> <tr> <td>R : 300 < TS \leq 1600°C</td> <td>\pm (0.05% of rdg +3.0°C)</td> </tr> <tr> <td>S : 300 < TS \leq 1760°C</td> <td>\pm (0.05% of rdg +3.0°C)</td> </tr> <tr> <td rowspan="2">B</td> <td>400 \leq TS \leq 600°C</td> <td>\pm5.5°C</td> </tr> <tr> <td>600 < TS \leq 1820°C</td> <td>\pm (0.05% of rdg +3.0°C)</td> </tr> <tr> <td rowspan="2">K</td> <td>-200 \leq TS \leq -100°C</td> <td>\pm (0.05% of rdg +3.0°C)</td> </tr> <tr> <td>-100 < TS \leq 1370°C</td> <td>\pm (0.05% of rdg +2.0°C)</td> </tr> <tr> <td rowspan="2">E</td> <td>-200 \leq TS \leq -100°C</td> <td>\pm (0.05% of rdg +3.0°C)</td> </tr> <tr> <td>-100 < TS \leq 800°C</td> <td>\pm (0.05% of rdg +2.0°C)</td> </tr> <tr> <td rowspan="2">T</td> <td>-200 \leq TS \leq -100°C</td> <td>\pm (0.1% of rdg +2.5°C)</td> </tr> <tr> <td>-100 < TS \leq 400°C</td> <td>\pm (0.1% of rdg +1.5°C)</td> </tr> <tr> <td rowspan="3">J</td> <td>-200 \leq TS \leq -100°C</td> <td>\pm3.7°C</td> </tr> <tr> <td>-100 < TS \leq 100°C</td> <td>\pm2.7°C</td> </tr> <tr> <td>100 < TS \leq 1100°C</td> <td>\pm (0.05% of rdg +2.0°C)</td> </tr> <tr> <td rowspan="2">N</td> <td>-200 \leq TS < 0°C</td> <td>\pm (0.1% of rdg +3.0°C)</td> </tr> <tr> <td>0 \leq TS \leq 1300°C</td> <td>\pm (0.1% of rdg +2.0°C)</td> </tr> <tr> <td>W</td> <td>0 \leq TS \leq 2315°C</td> <td>\pm (0.1% of rdg +2.5°C)</td> </tr> <tr> <td colspan="2">Reference contact compensation accuracy</td> <td>\pm1.0°C</td> </tr> </tbody> </table> <p>* Thermocouple diameters T - K: 0.32 ϕ, others: 0.65 ϕ</p> <ul style="list-style-type: none"> • Root mean square value \pm1.5% of F.S. (Average value) (Sine wave, 20 to 10 kHz) 	Thermocouple	Measurement Temperature Range (°C)	Measurement Accuracy	R/S	0 \leq TS \leq 100°C	\pm 7.0°C	100 < TS \leq 300°C	\pm 5.0°C	R : 300 < TS \leq 1600°C	\pm (0.05% of rdg +3.0°C)	S : 300 < TS \leq 1760°C	\pm (0.05% of rdg +3.0°C)	B	400 \leq TS \leq 600°C	\pm 5.5°C	600 < TS \leq 1820°C	\pm (0.05% of rdg +3.0°C)	K	-200 \leq TS \leq -100°C	\pm (0.05% of rdg +3.0°C)	-100 < TS \leq 1370°C	\pm (0.05% of rdg +2.0°C)	E	-200 \leq TS \leq -100°C	\pm (0.05% of rdg +3.0°C)	-100 < TS \leq 800°C	\pm (0.05% of rdg +2.0°C)	T	-200 \leq TS \leq -100°C	\pm (0.1% of rdg +2.5°C)	-100 < TS \leq 400°C	\pm (0.1% of rdg +1.5°C)	J	-200 \leq TS \leq -100°C	\pm 3.7°C	-100 < TS \leq 100°C	\pm 2.7°C	100 < TS \leq 1100°C	\pm (0.05% of rdg +2.0°C)	N	-200 \leq TS < 0°C	\pm (0.1% of rdg +3.0°C)	0 \leq TS \leq 1300°C	\pm (0.1% of rdg +2.0°C)	W	0 \leq TS \leq 2315°C	\pm (0.1% of rdg +2.5°C)	Reference contact compensation accuracy		\pm 1.0°C
Thermocouple	Measurement Temperature Range (°C)	Measurement Accuracy																																																	
R/S	0 \leq TS \leq 100°C	\pm 7.0°C																																																	
	100 < TS \leq 300°C	\pm 5.0°C																																																	
	R : 300 < TS \leq 1600°C	\pm (0.05% of rdg +3.0°C)																																																	
	S : 300 < TS \leq 1760°C	\pm (0.05% of rdg +3.0°C)																																																	
B	400 \leq TS \leq 600°C	\pm 5.5°C																																																	
	600 < TS \leq 1820°C	\pm (0.05% of rdg +3.0°C)																																																	
K	-200 \leq TS \leq -100°C	\pm (0.05% of rdg +3.0°C)																																																	
	-100 < TS \leq 1370°C	\pm (0.05% of rdg +2.0°C)																																																	
E	-200 \leq TS \leq -100°C	\pm (0.05% of rdg +3.0°C)																																																	
	-100 < TS \leq 800°C	\pm (0.05% of rdg +2.0°C)																																																	
T	-200 \leq TS \leq -100°C	\pm (0.1% of rdg +2.5°C)																																																	
	-100 < TS \leq 400°C	\pm (0.1% of rdg +1.5°C)																																																	
J	-200 \leq TS \leq -100°C	\pm 3.7°C																																																	
	-100 < TS \leq 100°C	\pm 2.7°C																																																	
	100 < TS \leq 1100°C	\pm (0.05% of rdg +2.0°C)																																																	
N	-200 \leq TS < 0°C	\pm (0.1% of rdg +3.0°C)																																																	
	0 \leq TS \leq 1300°C	\pm (0.1% of rdg +2.0°C)																																																	
W	0 \leq TS \leq 2315°C	\pm (0.1% of rdg +2.5°C)																																																	
Reference contact compensation accuracy		\pm 1.0°C																																																	
Reference contact compensation accuracy	Internal/External switching																																																		
Burnout detection	Detectable in dedicated mode (Not detectable during capturing)																																																		
A/D converter	16-bit (Effective resolution: Approx. 1/40000 of the +/- range)																																																		
Temperature coefficient	Gain : 0.01% of F.S./°C Zero : 0.02% of F.S./°C																																																		
Input resistance	1M Ω \pm 5%																																																		
Allowable signal source resistance	Within 1 k Ω																																																		
Maximum permissible input voltage	Between each input (+) terminal and each input (-) terminal: 20 mV to 2 V \rightarrow AC/DC 30V 5 V to 1000 V \rightarrow AC/DC 600V																																																		
	Between each input (-) terminal and each input (-) terminal : AC/DC 600V(CATIII)/ AC/DC 300V (CAT IV) Between each input (-) terminal and GND terminal : AC/DC 600V(CATIII)/ AC/DC 300V (CAT IV) * Expected transient overvoltage 6000 V																																																		

CHAPTER 4 Specification

Item	Description
Withstand voltage	Between each input (-) terminal and each input (-) terminal : AC/DC 5400V 1 minute
	Between each input (-) terminal and GND terminal : : AC/DC 5400V 1 minute
Insulation resistance	Between Input Ch and GND terminal: 50M Ω or more (At DC500V)
Common mode rejection ratio	90 dB or more (50/60 Hz; signal source 300 Ω or less)
S/N (Noise)	20 mV range: -40 dB or more (at +/- short) Other range : -50 dB or more (at +/- short)
Frequency response	DC to 200 kHz (+1/-4 dB)
Filter	OFF, Line, 5 Hz, 50 Hz, 500 Hz, 5 kHz, 50 kHz Attenuation -3 dB/Cutoff frequency Slope 6 dB/oct

4.2 Function Specifications

Function Specifications

Item	Description
Display screen	Waveform + Digital screen All Waveform screen Logging + Calculation Display screen X-Y screen * It is possible to open the menu even during capturing (Setting is impossible, for confirmation) * Switching by dedicated key (Toggle operation)
EU (scaling function)	Voltage, Root mean square value : 4 points can be set for each channel Temperature, Humidity : 2 points can be set for each channel (Offset function) Pulse : 2 points can be set for each channel (Gain function)
Functions during capture	Replaying the data during capturing
Data save function	Capturing destination: Built-in RAM/Internal memory/USB memory/SD card Captured data: Settings, Screen data, Measurement data
Capture function	Function: OFF, Ring recording, Relay recording
Ring capturing	Capturing destination: Internal RAM/Internal memory/USB memory/SD card Number of capturing points: 1,000 to 10,000,000 (No need to set the number of capturing points when using Internal RAM) Sampling interval: Internal RAM maximum speed 1 μ s/other fastest 1 ms (10 ms at capturing with CSV)
Relay capturing	Capturing destination: Internal memory, USB memory/SD card Sampling interval: Fastest 1 ms (10 ms at capturing with CSV)
Backup function	Function: OFF, 1, 2, 6, 12, 24 hours; specified time * In addition to the above, backup can be performed by key operation
Backup destination	Internal memory, USB memory, SD card, FTP
Sampling interval	Fastest 1 ms (10 ms at capturing with CSV)
USB memory	Function to replace the USB memory for backup destination
SD card	Function to replace the SD card for backup destination
Statistical calculation (Real time)	Types of operation: Maximum value, minimum value, P-P value, Average value Number of calculations: 4 arithmetic operations are displayed simultaneously. Calculation method: Free running, during capturing) Sampling interval: No limit (fastest 1 μ s)
Statistical calculation (Between cursors)	Types of operation: Average value, maximum value, minimum value, P-P value, root mean square value Number of operations: 5 arithmetic operation results are displayed simultaneously. Calculation method: Calculation between cursors (during replaying)
Search functions	Function: Searches for the target point in the captured data. Search type: Search by level of each channel search by logic pulse + combination search by generated alarm
Annotation enter function	Function : A comment can be entered for each channel Enterable characters : Alphanumeric characters Number of characters : 31

Trigger Functions

Item	Description
Repeat Trigger	Off, On
Repeat interval	Start to start interval, stop to start interval 1 second - 9999 hours 59 minutes 59 seconds
Trigger types	Start: Data capture starts when a trigger is generated. Stop: Data capture stops when a trigger is generated.
Trigger conditions	Start: Off, level, alarm, external input, specified time, specified day of the week, certain time, hourly Stop: Off, level, alarm, external input, specified time, specified day of the week, certain time * Level can be set to each CH.
Trigger judgment modes	Analog judgment: H/Rising, L/Falling, Window In, Window Out Logic judgment: H, L (Pattern comparison) Pulse judgment: H/Rising, L/Falling, Window In, Window Out
Combination of channel	Level OR, Level AND, Edge OR, Edge AND

Alarm Functions

Item	Description
Alarm judgment modes	Analog judgment: H, L, Window In, Window Out Logic judgment: H, L Pulse judgment: H, L, Window In, Window Out
Alarm detection cycle	Linked to the sampling interval (Fastest 1 μ s)
Alarm generation hold function	ON, OFF Setting available
Combination of channel	Level OR fixed

External Input/Output Functions

Item	Description
Input/output types	Trigger input (1 ch) or External sampling input (1 ch) Logic input (4 ch) or Pulse input (4 ch) Alarm output (4ch), or Trigger output (1ch) + Alarm output (3ch) * Trigger input and external sampling input can be switched. * Alarm output and trigger output can be switched.
Input specifications	Maximum input voltage : 0 to +30V (single-ended ground input) Input threshold voltage : Approx. +2.5V (logic input, pulse input) Approx. +1.9V (external trigger, external sampling) Hysteresis : Approx. 0.5V (+2.5V to +3.0V) (Logic input, pulse input) Approx. 0.2V (+1.9V to + 2.1 V) (external trigger, external sampling)
Alarm output specifications	Output format: Open collector output (5 V, pull-up resistance 10 k Ω) Contact capacity 5V to 24V, 100mA or less (0.2W or less) Output conditions: Level judgment, window judgment, logic pattern judgment, pulse judgment
Trigger output	When a trigger is detected after trigger output is set, a pulse of approx. 500 μ s width is output from the Output 1 terminal. (Low active)
Pulse input	Pulse sampling interval: 10 μ s to 1h * Set it separately from sampling interval. Setting faster than sampling interval is not possible (constant multiple) Revolutions mode (engines, etc.) Function: Mode to convert to the number of revolutions per minute by applying magnification after counting the number of pulses for each pulse sampling interval. Span: 10 to 500M Counts mode (electric meters, etc.) Function: Mode to accumulate the number of pulses for each pulse sampling interval from the start of measurement Span: Automatic (Maximum 20M) Inst. mode Function: Mode to display the number of pulses for each pulse sampling interval. The accumulated value for each pulse sampling interval is reset. Span: 10 to 20M Maximum number of pulse inputs Maximum input frequency : 100 kHz Maximum number of count : 15 MC (24-bit counter)
External sampling input	Maximum input frequency: 100 kHz Temporal error: 1 μ s or less.

4.3 Accessories/Optional Accessories

Control Software

Item	Item
Compatible operating system	Windows10/Windows8.1/Windows8/Windows7 (SP1 or later)
Function	Main unit control, realtime data capture, data conversion
Number of connected units	GL980_2000-APS: 1 devices, GL-Connection: 20 devices
Settings	AMP settings, capture settings, trigger/alarm settings, others
Capturing to internal RAM	Binary: Sampling interval 1 μ sec. to 1 min. * Transferring while capturing to internal RAM
Real time capturing	Binary: Sampling interval 1 msec. to 1 min. CSV: Sampling interval 1 msec. to 1 min.
Display	Analog waveforms, logic waveforms, pulse waveforms, digital values
Display modes	Y-T View, Y-Y View, Digital View
File conversion	Between cursors, All data
Statistic/History	Displays the maximum, minimum, average values, peak value

Standard Accessories

Item	Remarks	Quantity
Quick Start Guide	GL2000-UM-85x	1
CD-ROM	User's Manual, Application software	1
TO ENSURE SAFE AND CORRECT USE	SAFETY PAMPHLET	1
AC cable/AC adapter	100 to 240 VAC, 50/60 Hz	1
Ferrite core	For attaching each cable	3
M3.5 Flat screw	For thin-type thermocouple	10
Tilt stand	Tilt stand x2, M4 x 5 screw 2, M4x8 screw 2, specerx3	1

Battery Pack (Option)

Item	Description
Battery type	B-569 (7.2V/2900mAh)
Running time	Install 2 batteries in this device (2 batteries required for battery operation) LCD luminance MAX: Approx. 3 hours When screen saver is activated: Approx. 5 hours * Conditions 1-sec sampling, capturing to internal memory, new battery pack 2 pcs., +25°C environment.
Charging method	Mount in this device
Time required for charging	Battery pack x 1: approx. 5 hours Battery pack x 2: approx. 10 hours
Switchover in the event of a power failure	Because the battery is used together with the AC adapter, the power supply will be switched automatically to the battery in the event of a power failure. * The AC adapter is the primary power source.
Operation environment	Drive: 0 to 40°C, Charge: 15 to 35°C (power OFF) /15 to 25°C (power ON)
Other functions	<ul style="list-style-type: none"> • When the battery is running low, file is closed automatically. (When capturing to internal memory, USB memory or SD card) • Automatic backup to internal memory when capturing to internal RAM • Remaining amount indicator

List of Options

Item	Model	Description
Battery pack	B-569	7.2V/2900mAh
DC drive cable	B-514	2 m long (no clip on end of cable)
Input/output cable for GL	B-513	2 m long (no clip on end of cable)
Protect cover	B-579	
DIN rail mounting screw	B-570	Built to order
Storage case	B-581	
Humidity sensor *1	B-530	3 m long (with power plug)
Shunt resistor 250Ω	B-551	Built to order. ±250 Ω (0.1%), Rated power of 1 W, Maximum operating voltage 15.8V
Safety probe	RIC-141A	1:1 42pF, Length 1.2 m, 300VDC, CATII
Insulated BNC-BNC cable	RIC-142	Length 1.5 m, 1000VDC, CATII
Insulated BNC-banana cable	RIC-143	Length 1.6 m, 600VDC, CATII
Alligator clip (small)	RIC-144A	Aperture 11 mm, 300VDC, CATII, MAX15A
Alligator clip (medium)	RIC-145	Aperture 20mm, 1000VDC, CATII, MAX32A
Gran Bar clip	RIC-146	Aperture 5mm, 1000VDC, CATII, MAX1A
High withstand voltage insulated BNC-Banana cable	RIC-147	Length 1.6 m, 1000VDC, CATII
Safety adapter	SMA-102	Banana (female) → BNC conversion adapter (1 pc.)

*1: Allowable temperature range: -25°C to + 80°C

4.4 External Dimensions

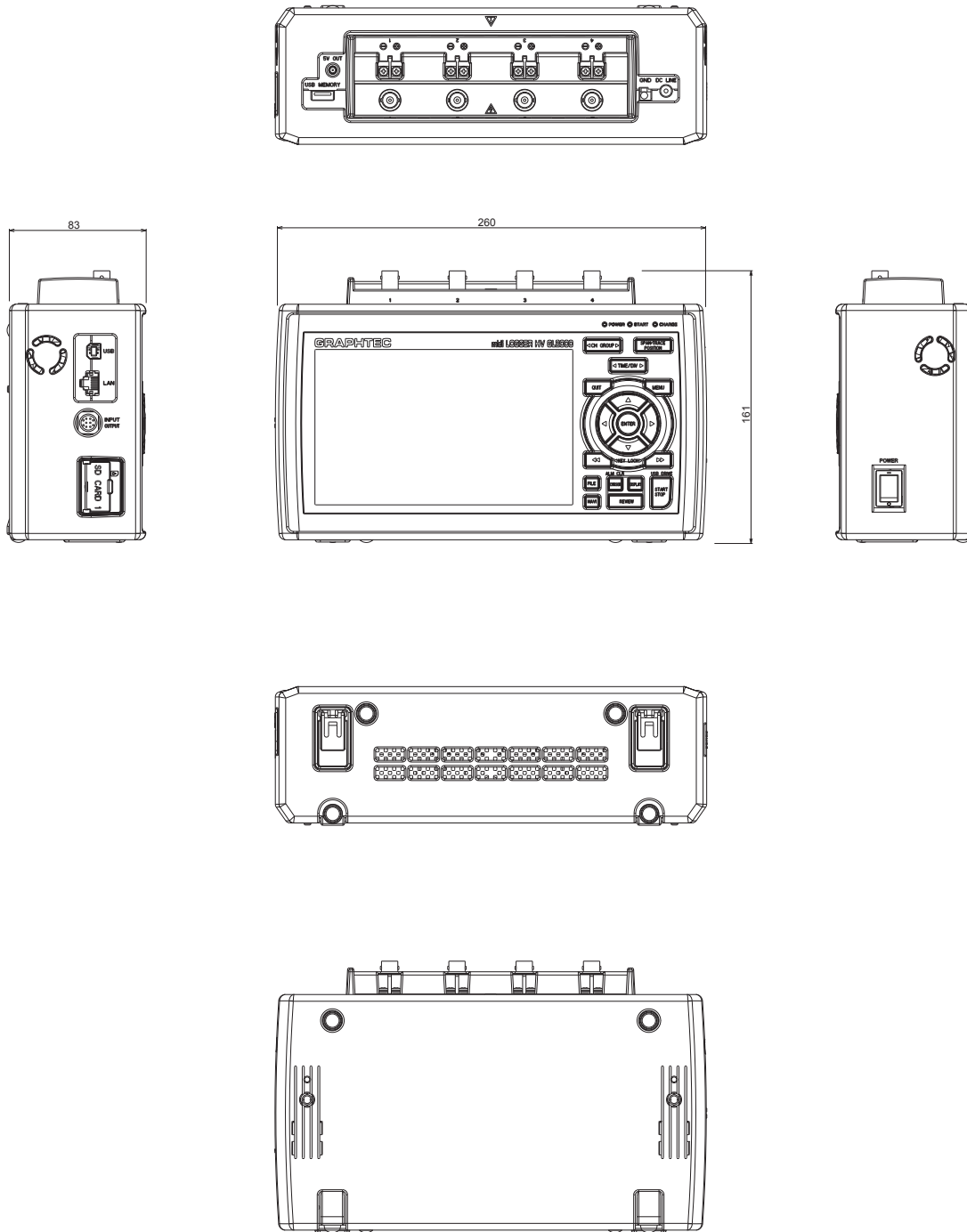

Terminals

Unit: mm
Dimension precision: Error ± 5 mm

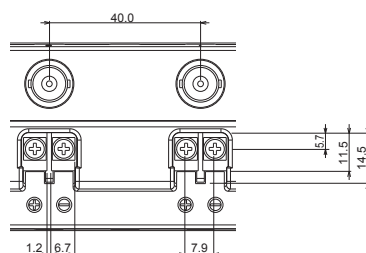

Unit: mm
Dimension precision: Error ± 0.5 mm

INDEX

- A**
- AC 3-8
 - AC Power Supply 2-7
 - Active CH (priority display CH) 3-30
 - Adjust Mode 3-112
 - A/D resolution 2-10
 - ALARM CLEAR 3-24
 - Alarm display 3-9
 - Alarm Functions 4-8
 - Alarm level settings 3-100, 3-101
 - Alarm occurrence hold 3-100
 - Alarm Output 2-12
 - Alarm settings 3-100
 - AMP settings 3-56
 - Analog settings 3-58
 - Annotation Settings 3-62
- B**
- Background Color 3-114
 - Backup setting 3-81
 - Battery Pack 4-10
 - Battery status indicator 3-8
- C**
- Cancel auto save 3-123
 - Capture bar 3-11
 - Capturing 3-54
 - Capturing destination 3-72
 - Capturing points 3-75
 - Change to Y-T display 3-133
 - Character string enter tool 3-127
 - Charging the Battery 2-21
 - Checking for Accessories 2-2
 - CH SELECT 3-17
 - Clock display 3-7
 - Connecting to a PC 2-18
 - Connection Using a USB Cable 2-18
 - Control Software 4-10
 - Create new folder 3-125
 - CURSOR 3-24
 - Cursor synchronization 3-131
- D**
- Data replay during capturing 3-54
 - Data replay menu 3-130
 - Data Save 3-120
 - Data search 3-132
- DATA settings 3-69
 - Date and Time 2-28
 - Date/Time 3-116
 - DC Power Supply 2-8
 - Dead zones (hysteresis) of trigger and alarm levels 3-103
 - Demo Waveform Mode 3-117
 - Device access display 3-6, 3-7
 - Digital display 3-131, 3-136
 - Digital display of measured value 3-44
 - Digital display of Y-T screen 3-8
 - Direction Keys 3-20
 - DISPLAY 3-23
 - DISP settings 3-82
 - DIV display 3-15
 - DNS address 3-108
 - Downloading files in this device 3-137
- E**
- Edge operations 3-102
 - End-of-line character 3-107
 - ENTER 3-20
 - Error Codes 3-139
 - EU 3-61, 3-67
 - External Input/Output Functions 4-9
 - External Sampling Input 2-11
- F**
- FAST FORWARD key 3-20
 - FILE 3-24
 - FILE menu 3-118
 - File name display 3-10
 - File Operation 3-118
 - Filter 2-10, 3-60, 3-66
 - Free Running 3-53
 - FTP server settings 3-109
 - FUNC 3-25
 - FUNC key settings 3-115
 - Function Specifications 4-7
 - Function Specificationsr 4-7
- H**
- How to attach the tilt stand 2-4
 - How to detach the rubber protector 2-5
 - How to insert the SD card 2-15
 - How to install USB memory 2-17
 - How to remove the SD card 2-16

I

Identification name 3-111
 Immediate backup 3-121
 Information 3-117
 Input 3-58, 3-66
 Input section 4-5
 Interface settings 3-105
 Internal memory 3-6, 4-3
 Internal RAM 4-3
 Internal RAM clear 3-75
 Internal RAM information 3-9
 IP Address 3-108

K

KEY LOCK 3-20
 Key lock display 3-7
 Key lock release with password 3-26
 Key Operation 3-17

L

LAN Connection 2-19
 Language 1-6, 3-117
 LCD brightness 3-113
 Level bar 3-9
 Level operations 3-102
 LOCAL 3-19
 Logging display 3-12, 3-37, 3-86
 Logic and Pulse settings 3-66
 Logic/Pulse 3-66
 Logic/Pulse Input 2-11
 Logic trigger 3-104
 L-R key mode and Cross key mode 3-46

M

Mail settings 3-109
 Memory block division 3-73
 MENU 3-21, 3-56
 Misc. 3-68
 Monitor 4-4
 Mounting the Battery Pack 2-20
 Move to selected position 3-131

N

NAVI function 3-117
 Nomenclature and Functions 2-3

O

Operating Environment 1-3
 Optional Accessories 4-10
 Options 4-11
 Origin 3-92
 Other settings 3-62
 OTHER settings 3-112
 Output 1 selection 3-100
 Overvoltage detection function 3-113
 Overwrite mode 3-73

P

PASV Mode 3-109
 PC I/F 4-4
 Pen status display 3-13
 Port number 3-108
 Power On Start 3-113
 Pre-trigger 3-97
 Pre-trigger mode 3-97
 Pulse sampling interval 3-71

Q

Quick setting 3-49
 Quick settings 3-8
 QUIT 3-19

R

Range 3-58
 RANGE mode 3-39
 Real time statistical calculation display 3-37
 Real time statistical calculations display 3-12
 Recording destination file name (auto save) 3-76
 Recording destination file name (file capture) 3-77
 Reflecting XY display 3-133
 Relay capture 3-80
 Remote lamp 3-7
 Remote operation 3-135
 Repeated capturing 3-99
 Replaying 3-55
 Return to default settings 3-117
 REVIEW 3-22
 Ring capture 3-79
 Ring capturing (internal RAM) 3-75
 Ring/Relay capture settings 3-79
 Room temperature compensation 3-114
 Rubber Protector 1-5

S

Sampling interval (main sampling interval) 3-70
 Save/Read the current setting 3-124
 Scale upper/lower limit 3-10
 Scaling settings 3-61, 3-67

- Screen copy 3-123
- Screen display..... 3-136
- Screen Saver..... 3-113
- SD card 3-6, 4-3
- SD CARD 2-15
- SD card Remove/replace 3-122
- Simple setting 3-48
- Slope 3-67
- Span 3-31, 3-92
- SPAN mode..... 3-39
- SPAN/TRACE/POSITION 3-18
- Specified time setting 3-104
- Standard Accessories..... 4-10
- Standard Specifications 4-2
- Start side source setting 3-96
- START/STOP 3-21
- Statistical calculation between cursors..... 3-132
- Status mark 3-6
- Status message 3-5
- Stop side source setting 3-96
- Synchronized Time 3-112
- T**
- TCP/IP advanced settings..... 3-108
- Temperature settings 3-114
- Temperature unit 3-114
- Thumbnail display 3-126
- Time/DIV 3-30
- TIME/DIV..... 3-19
- Time/DIV display 3-5
- To Ensure Safe and Correct Use i
- Trigger Functions 4-8
- Trigger Input 2-11
- Trigger level settings..... 3-101
- TRIG settings 3-94
- U**
- USB Drive Mode 3-21
- USB memory..... 3-7
- USB memory Remove/replace 3-122
- USB Memory slot 4-3
- USB settings..... 3-107
- V**
- Vernier..... 3-91
- VERNIER..... 3-42
- Vernier reference line 3-15
- W**
- Warming-up Before Use 1-3
- Waveform clears at the start of recording..... 3-92
- WEB Server..... 3-134
- WEB server settings 3-109
- When tilt foot is used..... 2-4
- Window names 3-2
- X**
- X-axis level bar 3-15
- XY digital display..... 3-43
- XY display clear 3-92
- XY display settings 3-133
- XY Execution..... 3-133
- XY overwrite 3-123, 3-133
- XY Overwrite..... 3-93
- XY overwrite display 3-51
- XY position 3-41
- XY position reference line..... 3-16
- XY screen digital display..... 3-14
- XY upper/lower scale 3-16
- XY waveform display..... 3-15, 3-39
- Y**
- Y-axis level bar 3-15
- Y-T waveform display 3-10, 3-27
- Z**
- Zero point 3-92
- Zone division..... 3-28

Specifications are subject to change without notice.

GL2000 User's Manual
GL2000-UM-151
June 11, 2021 3rd edition-01

GRAPHTEC CORPORATION

GRAPHTEC