

GL980_2000-APS

Application software

USER' S MANUAL

MANUAL NO. APS(GL980_2000)-UM-151

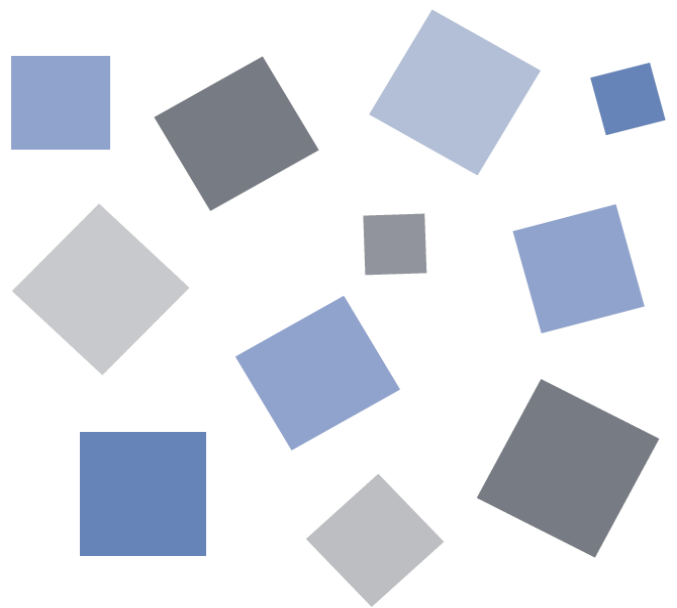

GRAPHTEC

Contents

1.Main Features

A Variety of Display Formats	4
Simple and Easy to Use.....	5
Thumbnail Waveform Display	5
Export to Direct Excel File Function.....	6
CSV File Batch Conversion	6
Printing Function, Screen Save Function.....	7
Help Function.....	7

2.System Requirements

3.Connecting to a PC (Personal Computer)

Connecting via USB	9
Connecting via LAN	10
Setting IP Address or USB ID	11
USB Settings.....	11
TCP/IP Settings	11
Example of TCP/IP Settings	12

4. Installing the USB Driver

5. Installing the Application Software

6. Launching and Exiting the Software

Launching the Software	15
Exiting the Software	15

7.Basic Operating Procedure

Controlling the GL Device	16
Checking Input Data	17
Data Capture.....	18
Replaying Captured Data.....	19

8.PC Connection Settings

Connection display.....	20
Manual Connection.....	21
Connecting operation.....	21

9. Display Screens

Y-T (Main Screen).....	22
Y-T expanded display	24
Statistics and History	25
Operation Icons.....	26
XY	30
Operation Icons.....	31
Replay Screen	32
Y-T	32
Statistical Screen	33

10.Menu

Open PC File	34
Open Device File	35
File History	35

Convert then Save	36
Superimpose/Link	37
CSV File Batch Conversion	38
Print Screen	39
Save Screen	40
Language Settings	41
11.Settings Screens	
AMP Settings	42
Span Settings.....	44
EU Settings.....	45
Adjustment settings.....	46
Data Capture Settings.....	47
Review Device Settings	49
PC Capture Settings	49
Direct EXCEL Settings.....	50
Trigger/Alarm Settings	51
Trigger Level Condition.....	53
Alarm Condition	55
Alarm Mail Settings.....	56
Other Settings	57
12.Data Capture	
Settings	58
Settings related to AMP	58
Settings related to data capture	59
Start	60
Behaviors When Using the Internal RAM	60
Behaviors during Data Capture.....	60
Stop.....	61
13.Replaying Data	
Replaying File	62
Cursor Operations.....	64
Checking Cursor Information	64
Input Comments.....	65
Data Search	66

1. Main Features

A Variety of Display Formats

Data can be viewed in Y-T, XY, on large, easy-to-read screens.



Y-T

Input signals are displayed in the Y axis, and time axes are displayed in the X axis. With a button, you can expand/shrink time axes and the X axis. Also, a graph can be divided into two or four parts to display each signal.

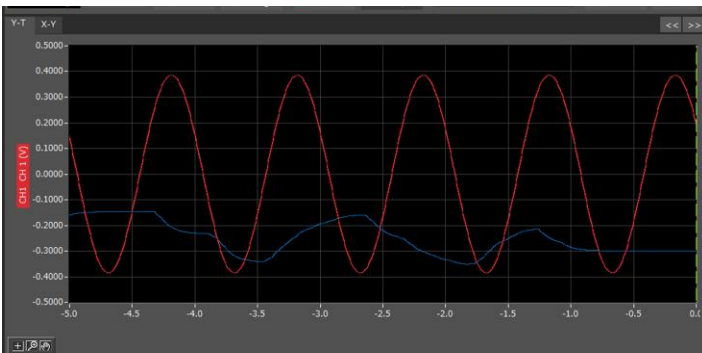

Y-T expanded display

Displays the waveform with a large window width so that it is easier to see.



Statistics and History Display

Maximum, minimum and average values can be confirmed during recording. Alarm operation can be displayed as a list in time sequence for your confirmation.

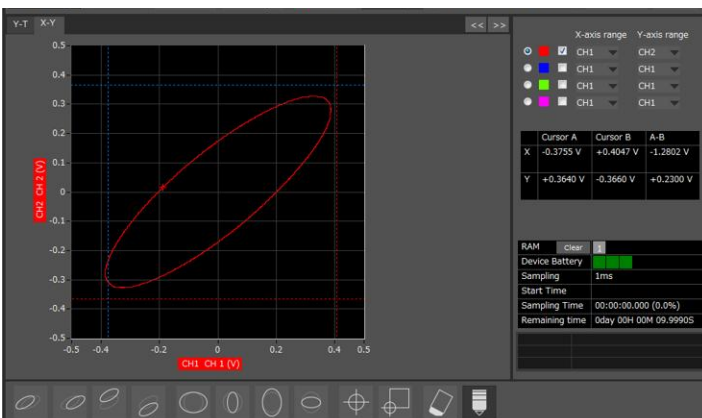

XY

Input channels can be specified to the X and Y axes to check correlated waveforms.

Four channels are provided, and any channels can be specified for the X and Y axes. Also, you can expand/shrink the span or move positions intuitively.

Simple and Easy to Use

Large icons make it simple and easy to control the waveforms. Time axes, spans, waveform positions can be changed easily. Also, you can maximize a window to fit the screen.

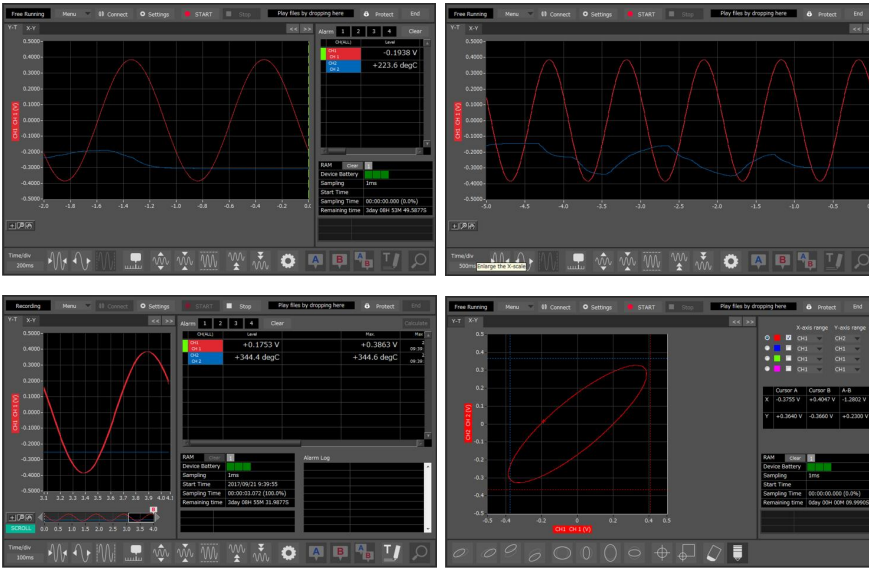

Thumbnail Waveform Display

Before replaying captured data, the waveforms can be checked by referring to the small images (thumbnails) provided next to each file name. These thumbnails provide easy confirmation of the data before opening the file.

Thumbnail	File Name	File Size	Date	Time
	20170822_133121.gbd	34.67kByte	2017/08/22	13:31:22
	20170822_133200.gbd	208.19kByte	2017/08/22	13:32:22
	20170822_222514.gbd	1.53MByte	2017/08/22	22:25:22
	20170822_223113.gbd	534.57kByte	2017/08/22	22:31:22
	20170822_223151.gbd	317.09kByte	2017/08/22	22:32:22

Printing Function, Screen Save Function

The waveform screen can be printed out on a printer, and screen copies saved to a file.
(Note: To use the printing function, the device must be connected to a printer.)

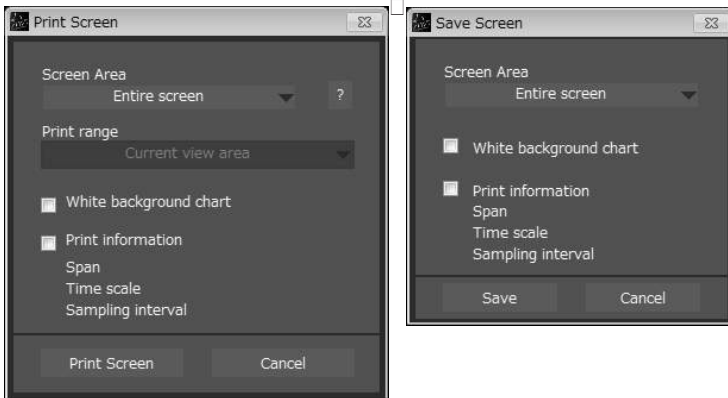

Help Function

Help buttons that provide simple descriptions of the various functions are assigned to each of the menu setting items to provide ease of use.

2. System Requirements

Make sure that the computer on which you plan to install the software meets the following requirements.

Item	System requirements
OS	Windows 10 (32/64bit) Windows 8.1 (32/64bit) Windows 8 (32/64bit) Windows 7 SP1 (32/64bit)
CPU	Intel Core 2 Duo or more is recommended.
Memory	1GB or more is recommended.
HDD	32 GB or more free space is recommended.
Display	1024 x 768 resolution or higher, 65535 colors or more (16-bit or more)
Other	USB port, TCP/IP port, CD-ROM drive (for installing from CD) Microsoft Excel software (for the Export to Direct Excel File and Display in Excel functions)

● CHECKPOINT

- Even when using a PC that meets the system requirements, measurement data may not be captured correctly depending on the PC status (e.g. running other applications or insufficient memory capacity in the storage media used). Exit all other applications before capturing data to the internal hard disk.
- While you are using this software, do not activate any other software. Whenever possible, avoid manipulations or processing of other software than this one (e.g., screen saver, virus check, file copy and transfer, and file search processing, etc.).

3. Connecting to a PC (Personal Computer)

Connecting via USB

The GL is connected to a PC via a USB cable.

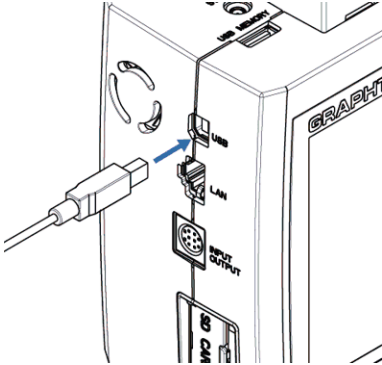

● CHECKPOINT

- When using a USB cable, a USB driver must be installed in the PC. Please see "Installing the USB Driver" for the installation procedure.
- LAN connector. Make sure the cable is inserted into the correct connector.

Use an A-B type USB cable to connect the GL to a PC.

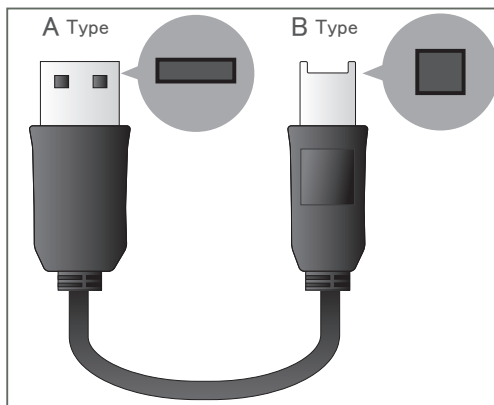

Connecting via LAN

It can also be connected via a LAN cable.

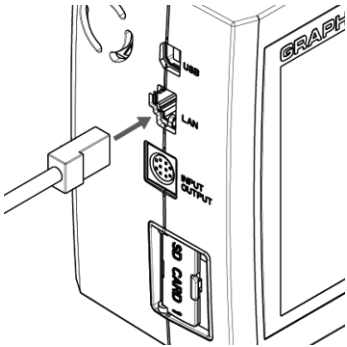

● CHECKPOINT

- You cannot take full advantage of the software when using a TCP/IP. Use a USB connection (USB2.0 port).

Depending on your usage, use one of the following types of LAN cables.

●LAN Cable Types

Use a crossing cable when connecting directly to a PC, without using a hub.

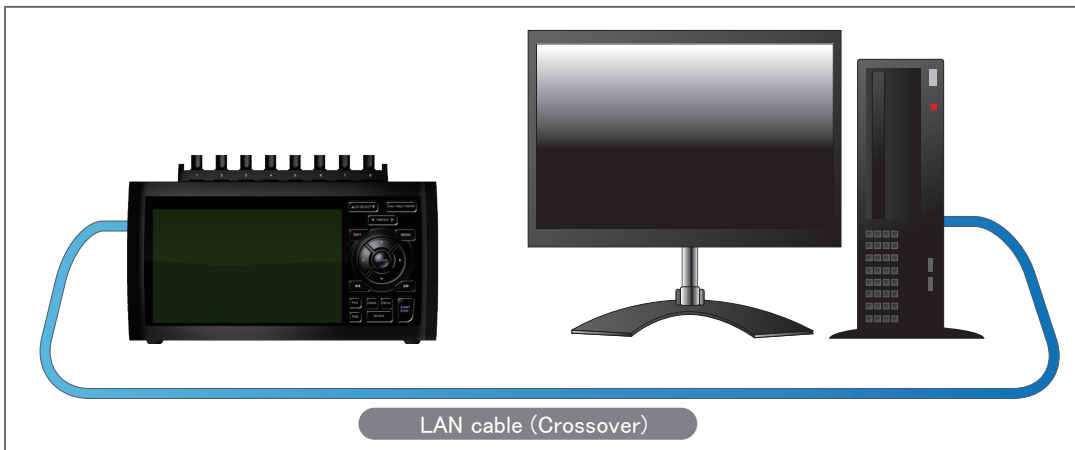

Use a straight cable to connect to a PC through a hub.

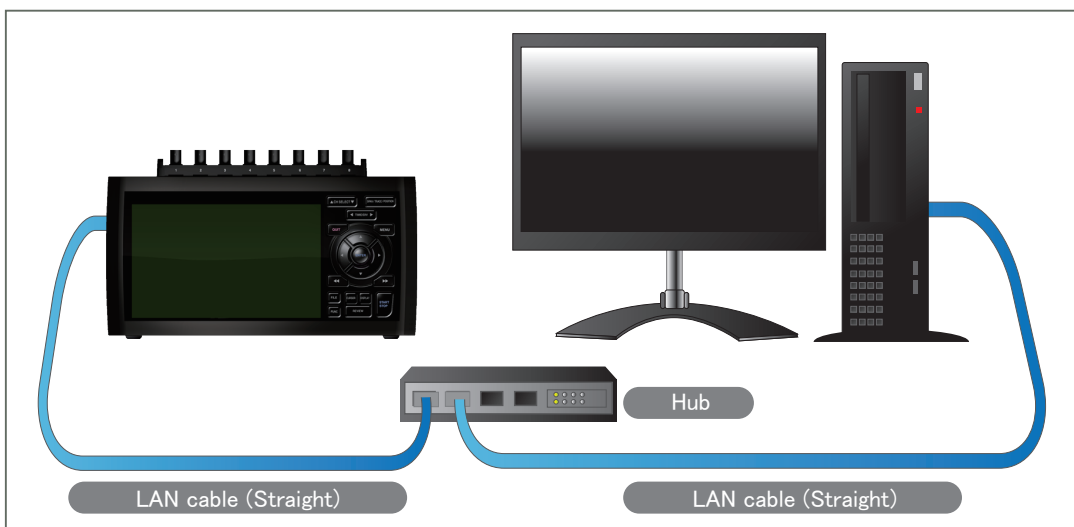

Setting IP Address or USB ID

To connect to a PC, configure the device's interface settings.

USB Settings

Press the MENU key five times to open "I/F". Input the "USB ID".



TCP/IP Settings

Press the "MENU" key five times to open "I/F".

Configure "Detailed".

Set "IP Address", "Subnet Mask", "Port Number", and "DNS Address" and select [Reflect Settings] to accept the changes.

- Using Auto IP Address Acquisition

If there is a DHCP server in the same segment of the connected network, Auto IP Address Acquisition is available.



Example of TCP/IP Settings

Connecting one PC and one GL

Refer to the following settings if you are not connecting to a corporate LAN or other networks.

Connect GL to a PC with a crossover cable.

PC's IP Address	192.168.1.1
GL's IP Address	192.168.1.2

● CHECKPOINT

- In this case, always set the subnet mask to "255.255.255.0".
- In this case, always set the port number to "8023".

Setting PC's IP Address

[Control Panel] → [Network and Sharing Center] → [Local Area Connection] → [Properties]
[Select Internet Protocol (TCP/IP)] → [Properties] → Check "Use the following IP Address" →
Set [IP Address] and [Subnet Mask] → [OK]

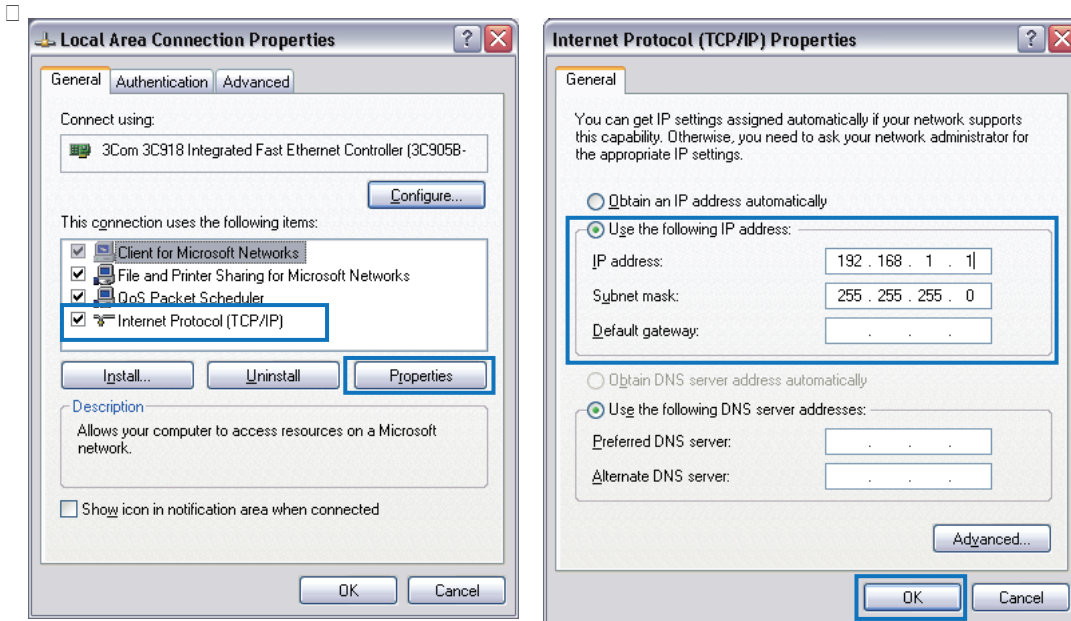

4. Installing the USB Driver

To connect this unit to a PC with the USB interface, a USB driver must be installed in the PC. A USB driver and the USB driver installation manual are included in the supplied CD-ROM.

5. Installing the Application Software

This chapter describes how to install the application software.

1. Insert the User's Guide CD-ROM provided into the PC's CD-ROM drive.
2. Click the Taskbar's Start button, and then click the Run... icon to open the "Run" window.
3. Enter the CD-ROM drive name and \GL980_2000-APS\Setup_English.exe as the name of the file you wish to open.

If the disk is in drive D, for example, enter "D:\GL980_2000-APS\Setup_English.exe" in the box and then click "OK" to launch the installer.

4. Follow the instructions on the screen to continue with the installation.
5. When a message to restart your PC appears after the installation, be sure to restart it and then start this software.

● CHECKPOINT

Be sure to observe the following points when connecting the GL to a PC.

- Do not connect any devices apart from a mouse or a keyboard to any of the other USB terminals on your PC.
 - Set the PC's power-saving functions to Off.
 - Set the Screen Saver to Off.
 - Set the anti-virus software auto update and scan scheduler functions to Off. Also, set the Windows auto update and scheduler functions to Off.
 - When using the note PC, if you close the display, the PC may be in stand-by mode. Please do not close the display during using the software.
-

Trademarks

- Windows, Windows Vista and Windows 7 are registered trademarks of Microsoft Corporation in the US and other countries.
 - The company names, logos and product names mentioned herein are the trademarks or registered trademarks of their respective companies.
-

6. Launching and Exiting the Software

Launching the Software

Click the Taskbar's "Start" button → "GL980_2000-APS" to launch the application software.
Once the program has started up, the following screen is displayed.

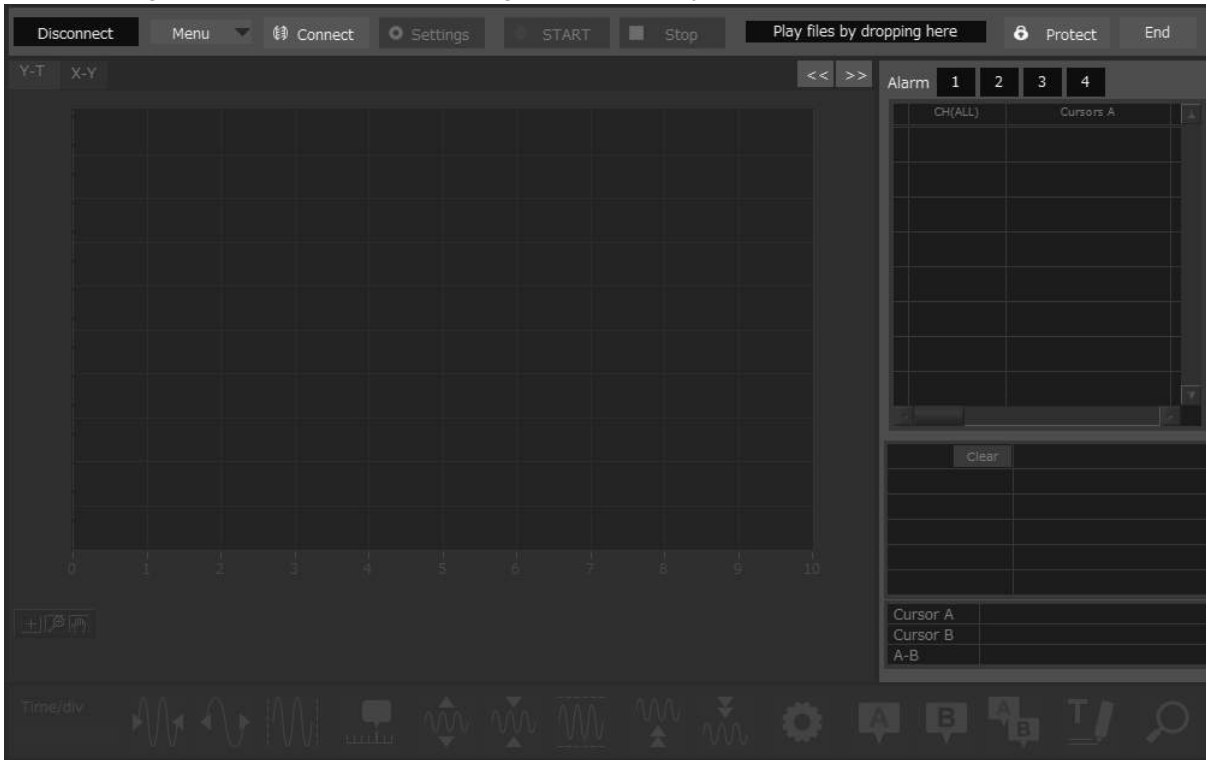

Exiting the Software

To exit the software, click the "End" button in the upper right corner of the main screen.

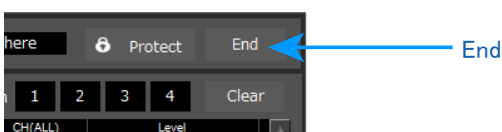

7. Basic Operating Procedure

The basic operating procedure of this software consists of the following four operations

Operation	Description
Controlling the GL Device	When the GL is connected to a PC via a USB/LAN cable, it can be controlled using this software. The setting conditions can be saved as a configuration file in a PC. This file can be read to reflect the setting conditions.
Checking Input Data	When the GL is connected to a PC, signals input in the GL can be viewed in a graph on this software. They can be also checked in Zoom and FFT formats which are not provided with the GL.
Data Capture	When the GL is connected to a PC, data can be exported to a PC and saved. Data can be also saved in the GL. Either of the saved data can be used as a backup.
Replaying Captured Data	Data files captured and saved in a PC can be replayed. When the GL is connected to a PC, data saved in the GL can be also replayed. You can clip the desired parts from the replayed data or convert it to a different file format and save it.

Controlling the GL Device

This software can perform the following operations:

- Start/Stop Data Capture
- AMP Settings (Input, Range, Filter, etc.)
- Data Capture Settings (Sampling Interval, Device Data Capture Destination, Data Points, etc.)
- Timer, Trigger Settings (Timer Settings, Trigger Settings, Alarm Settings, etc.)
- Other Settings (Temperature Unit, Factory Default Settings, etc.)

Checking Input Data

Data can be checked in the following formats on this software:

- Y-T Waveform Display



- Y-T expanded display

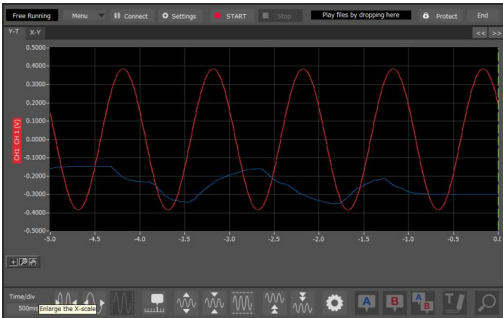

- Statistics and History Display



- XY Display

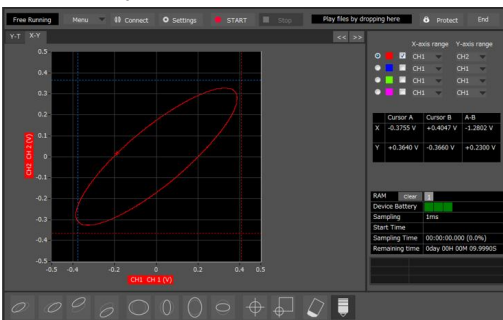

Data Capture

You can select the data capture method on this software depending on the setting of the device data capture destination.

	Internal RAM	Internal Flash Memory/USB Memory	No Capture
Sampling Interval	1 μ s or above	1ms or above	1ms or above
Allowable Capture Capacity	Up to 4 million data points	Internal flash memory: Up to 4MB SD card, USB memory: depending on its capacity (*up to 4GB for one file)	Depending on your PC's capture device (* up to 4GB for one file)
Save to the Device	Data will be erased when the power is turned Off.	The captured data will be saved in a file. The data will be retained even after the power is turned off or during the next data capture starts.	No data is saved.
Features	Data can be captured at the fastest sampling interval 1 μ s. The pre trigger function can be used only when the internal RAM is used.	Data can be directly captured to a PC and to the device concurrently. When there is no limitation such as a timer stop or a trigger stop, data capture will stop at the time 4GB of data is captured to the internal flash memory, SD card, USB memory, or at the time they become full.	Data is directly captured to a PC only, not to the GL. Long-time data capture can be done, because it does not stop due to the GL device capacity.

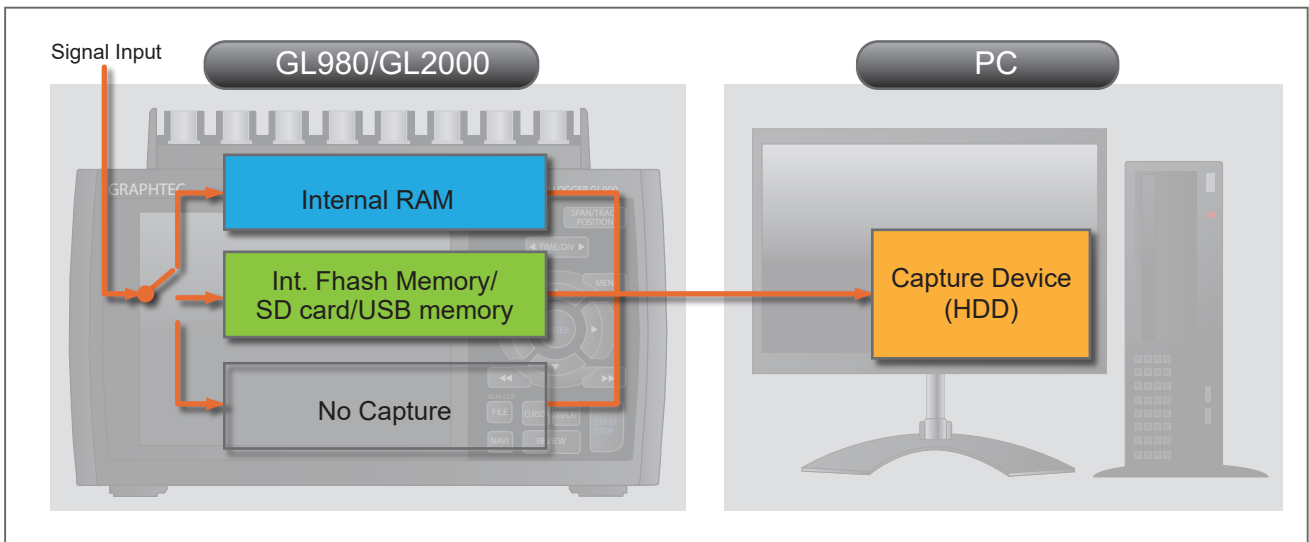

Replaying Captured Data

Playback of recorded data

The data of binary data (*.GBD) recorded with this software and text data (*.CSV) recorded on the PC side or with the GL900/GL2000 main unit can also be played back.

During playback, you can display cursor information to confirm the level value and time at the cursor position and also search for places where the level value has exceeded a specified value.

You can also perform XY display and statistical calculations for a specified range.

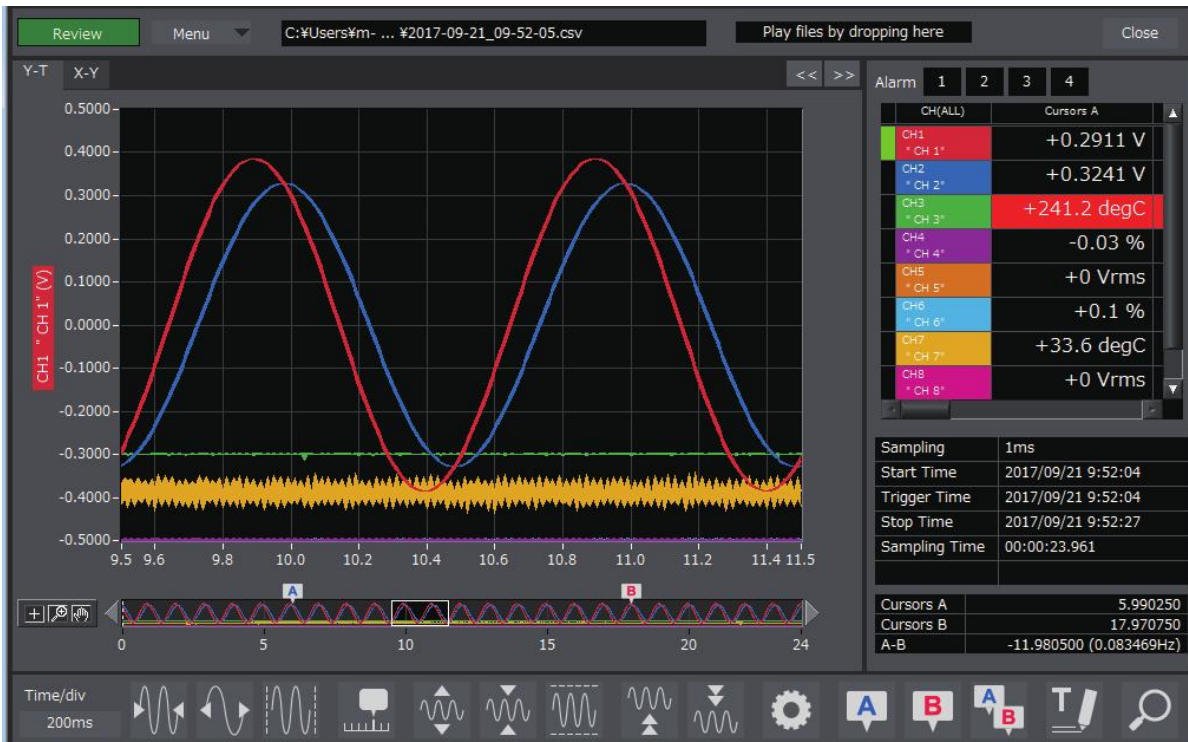

8. PC Connection Settings

Configure the communication settings between GL and a PC.

By clicking the "Connect" button in the main screen, the connection screen will appear.

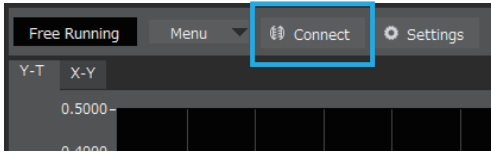

Connection display

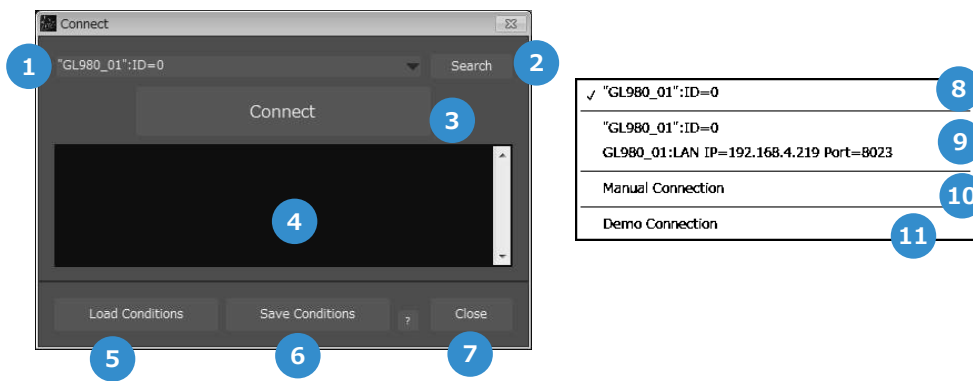

No.	Name	Description
1	Connection device selection	Select the device to connect to and the connection method.
2	Search	A search for a connected GL980/GL2000 will be performed. USB connections and LAN connections (local connections) are applicable to the search. *With LAN connections, a GL980/GL2000 installed in a separate segment via a router cannot be searched.
3	Connect	Connects to the device selected in connection device selection.
4	Connection information	Displays the status of the connected device.
5	Load Conditions	Loads the configured file saved with save settings and restores the setting status.
6	Save Conditions	Saves the current setting status as a file.
7	Close	Closes the connection screen.
8	Previously connected device	Displays the previously connected device.
9	Devices found during search	Displays devices found during the search.
10	Manula Connection	Directly specifies the IP address or domain of a GL980/GL2000, etc. connected to the internet.
11	Demo Connection	With demo connection, a mock connection is established without connecting to a GL main unit. A demo waveform prepared in advance will be displayed. Settings cannot be changed with the demo connection.

Manual Connection

Directly specifies the IP address or domain of a GL980/GL2000, etc. connected to the internet.
For the port number, set the port number configured with the GL980/GL2000. The default value is 8023.

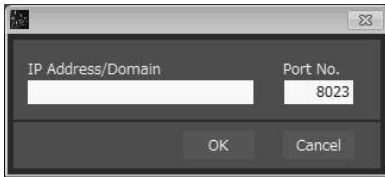

Connecting operation

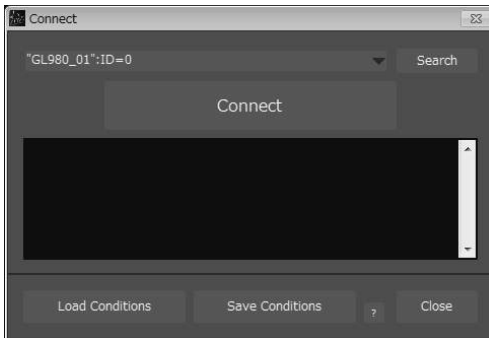

1. When the connection screen is opened, connected GL980/GL2000 will be automatically searched.
2. Select a device that has been searched.
3. Press the "Connect" button to conduct communication connection.
4. Press "Close" to close the connection screen.

● CHECKPOINT

- Before making a connection, check that this unit is either in a "STOP" or "REC" status.
 - When they are connected, the software works with the setting conditions read from the GL unit. When you want to use the PC's settings, press the "Read Setting Conditions" button to read the saved configuration file. To do this, you should save the setting conditions. The following settings are not saved to this unit.
-

9. Display Screens

This chapter describes the various screens used in this software.

Y-T (Main Screen)



No.	Name	Description
1	Status	The status of a PC and the device is displayed here.
		Free Running Stopped status (not capturing data)
		Armed Awaiting trigger activation; data has not been captured.
		Recording Data capture status
		RAM transfer Internal RAM data is being transferred.
Finished Recording end status. Press the "Stop" button.		

2	Menu	Operations related to files are performed.	
		Open File	Displays the data in files stored on the PC or files stored on this unit as waveforms.
		Review Device	Opens a file in the main unit when connected to a GL980/GL2000.
		File History	Files opened, captured, and converted in the past will be listed as log and can be played.
		Convert then Save	Click this button to convert data being replayed into GBD or CSV files and save them. Data cannot be saved during Free Running.
		Superimpose/Link	For the reviewing data, you can overwrite the waveform of other captured data or link and display the waveform.
		CSV file batch conversion	Click this button to convert multiple GBD (binary data) files captured to the PC to CSV files.
		Print Screen	Click this button to print out a copy of the displayed screen. Printing is performed at the printer that has been selected as the default printer. If you change the printer, set the printer and then restart the software.
		Save Screen	Click this button to save the displayed screen as a PNG file.
		CSV config	Sets the decimal point and delimiter character of the CSV file.
Language Settings	Switch the displayed language. It will be necessary to reactivate this software in order for the configuration to be reflected.		
3	Connect	Click this button to open the screen to connect to the device.	
4	Settings	Click this button to open the screen to make settings to the device.	
5	Start	Click this button to start data capture.	
6	Stop	Click this button to stop data capture.	
7	File drop playing area	Files can be played by dropping GBD/CSV files in this area.	
8	Protect	Click this button to set the password to protect the software. * Protection operations occur only in this software. Be careful that this software can be exited via Windows operations.	
9	End	Click this button to exit the application.	
10	Screen switching	Switches between screens (Y-T/XY).	
11	Switch display	Switches the waveform display area.	
12	Display alarm Statistical calculation items	Displays the status of the alarm output port. Executes a statistical calculation during playback.	
13	Digital	The digital values are displayed in this area. Clicking on any of the CH numbers enables the waveform for that channel to be hidden/displayed. The channels for which an alarm has been generated are shown in red. The waveform display On/Off setting is cleared when the capture settings are changed and is reset to On.	

14	Display information	Displays information.	
		Internal RAM block	Displays the status of internal RAM blocks. ■ Gray: Not recorded. ■ Green: Recorded.
		Battery status	Displays the status of the battery. ■■■ Power drive ■■■ Battery High ■■■ Battery Medium ■■■ Battery Low
		Sampling	Displays the sampling interval.
		Start time	Displays the recording start time.
		Sampling time	Displays the recording time.
		Remaining time	Displays the remaining recording time.
15	Cursor Time	The cursor times are displayed during data capture when Scroll Off has been selected.	
16	Waveform Graph	The waveforms are displayed here.	
17	Scale operations	Operate the scale.	
18	Operation Icons	Click the icon to perform various settings for the waveform display.	

Y-T expanded display

By pressing the button on the right side of switch display, you can switch to the full screen display.

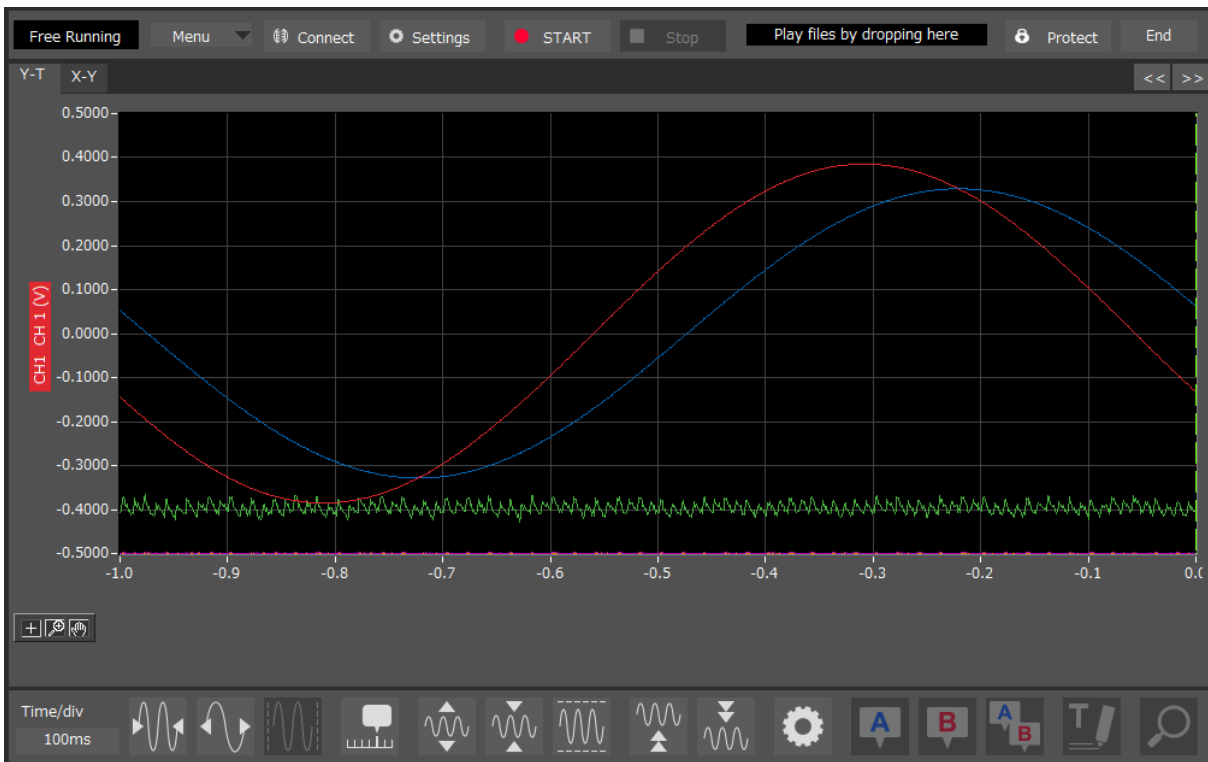

Statistics and History

By pressing the button on the left side of switch display, you can switch to the statistics and alarm history display.

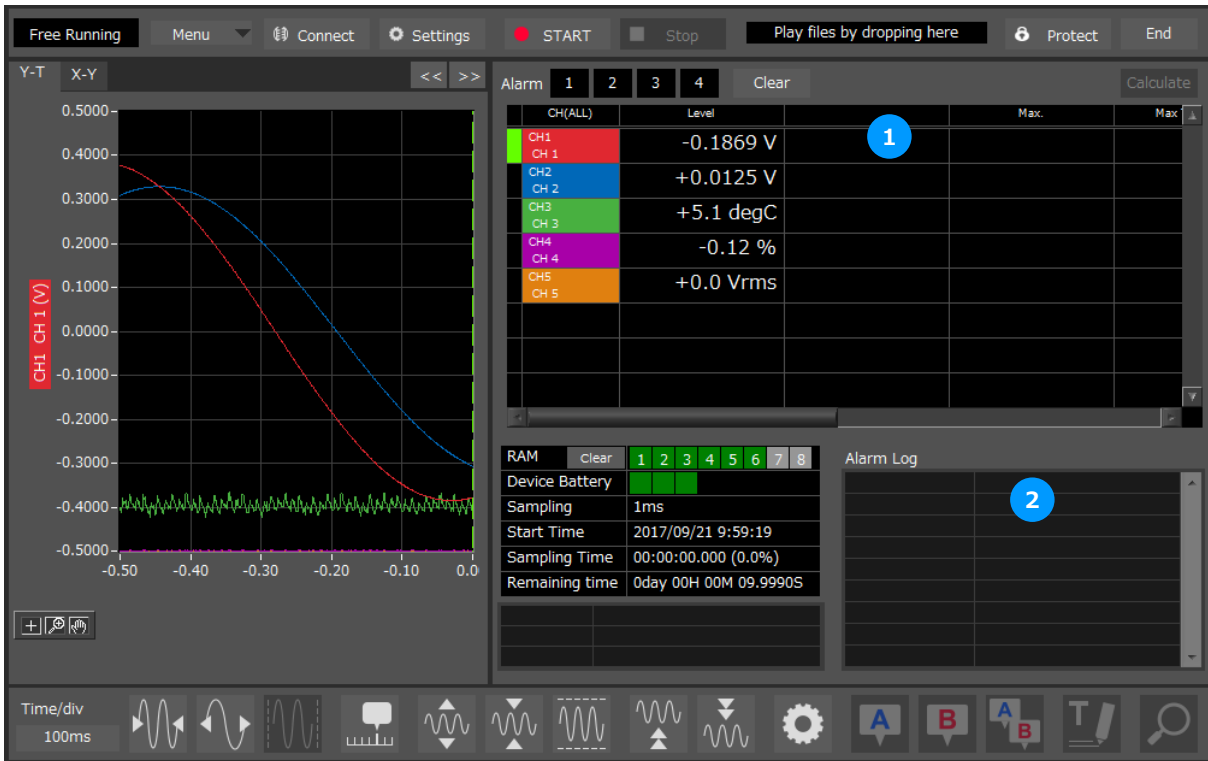

No.	Name	Description
1	Statistical List Display	Displays statistical value of each CH.
2	Alarm History	Displays history of alarm operation. Maximum of 100 alarms are displayed.

Operation Icons

Y-T View provides control icons that allow you to perform intuitive operations. Each of the icons has the following functions:

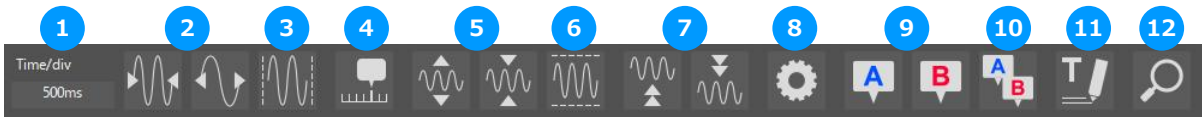

No.	Name	Description				
1	Display Time/Div	Time/Div of the displayed graph is displayed here. Time/Div is a time scale in the X axis.				
2	Expand/Shrink Time/Div	Click these icons to expand/shrink the time scale in the time (X) axis.				
3	X axis auto scale	Displays all data on a single screen.				
4	Switch Scale	Click this icon to switch between a relative time and an absolute time. <table border="1" data-bbox="523 689 1406 831"> <tr> <td>Relative Time</td> <td>The time from the start is displayed. It is fixed in the Free Running status.</td> </tr> <tr> <td>Absolute Time</td> <td>An absolute time (date and time) is displayed. This function does not exist in the Free Running status.</td> </tr> </table>	Relative Time	The time from the start is displayed. It is fixed in the Free Running status.	Absolute Time	An absolute time (date and time) is displayed. This function does not exist in the Free Running status.
Relative Time	The time from the start is displayed. It is fixed in the Free Running status.					
Absolute Time	An absolute time (date and time) is displayed. This function does not exist in the Free Running status.					
5	Expand/Shrink Y axis span	Click this icon to expand/shrink the Y axis for the selected channel.				
6	Y axis auto scale	Automatically adjusts the span width in relation to the selected operation CH.				
7	Move Y axis position	Click this icon to move up and move down the Y axis position for the selected channel.				
8	Waveform Operation	Click this icon to open the screen to edit graph waveforms.				
9	Displays Cursor	Displays Cursor A/B in the waveform display.				
10	Curcor Sync	Click this button to move cursors A and B concurrently while they are kept distance.				
11	Comment	Allows you to enter a comment on a waveform of a desired channel during capture or replay. The entered comment will be redisplayed when the file is opened again.				
12	Move/Search	During replay, click this icon to open the screen to move to the desired time or points and to search at any level.				

Waveform Operation

Various waveform operations can be performed.

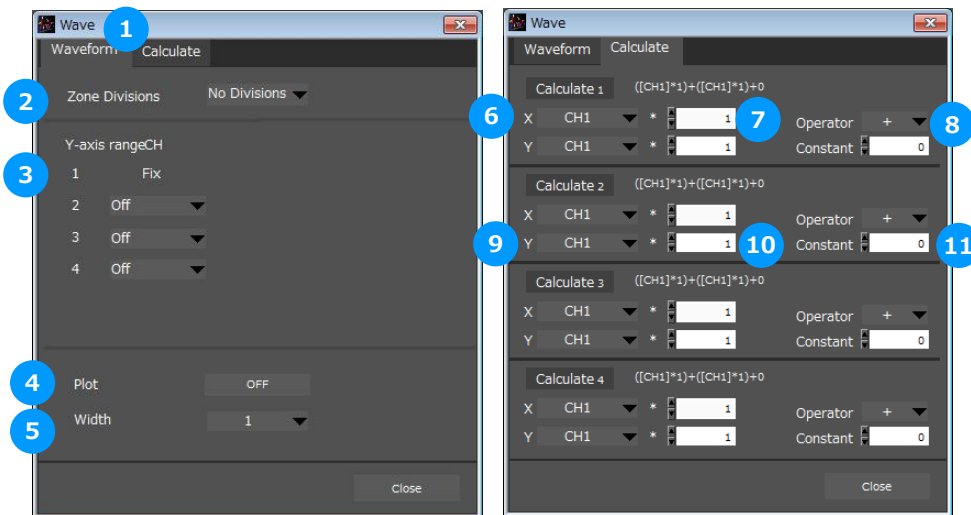

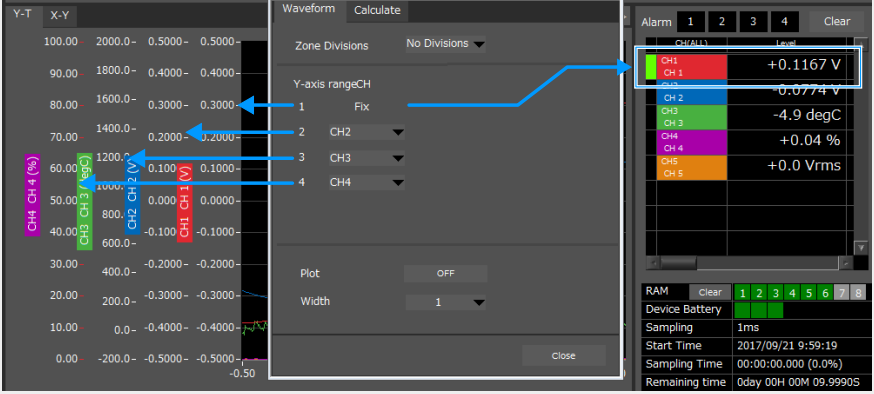
No.	Name	Description
1	Switch tab	Switches between the waveform operation tab and the inter-CH calculation tab.
2	Zone Divisions	Splits the Y-T wave form graph horizontally. (No splits / 2 splits / 4 splits / 8 splits) When zones are split, each CH can be assigned to a split zone. 
3	Y axis range	Up to 4 maximum range display on the Y axis can be displayed when zoning is not divided. Y axis Range 1 is fixed and displays the range of the CH selected in the digital screen. 
4	Line Width	Change the line width of the waveforms. (1/2/3/4)
5	Plot	Click this button to display plot marks at the actual sample points on the waveforms.
6	X CH setting	Configures the calculation CH for setting the calculation. (*The units will follow that of CH X.)

No.	Name	Description
7	X side coefficient	Configures the coefficient to multiply the X CH by.
8	Operator	Selects the arithmetic operator. (+, -, *, /)
9	Y side CH setting	Configures the calculation CH for setting the calculation.
10	Y side coefficient	Configures the coefficient to multiply the Y CH by.
11	Constant	Configures the constant to add.

Input Comments

Click this icon to input a comment above the waveform of the desired channel during a data capture (replay) operation. If the scroll is ON, the input position is at the "Comment Input" in the upper part of a waveform. If the scroll is OFF, it is the position of Cursor A or B.

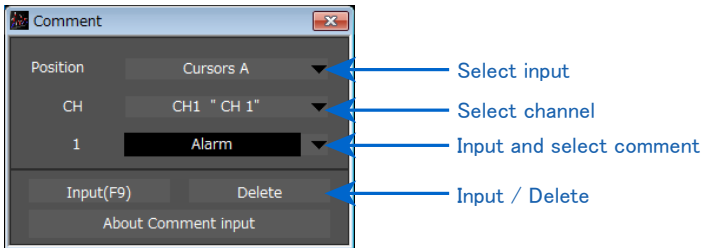

Move/Search

During replay, cursor A and the waveforms can be moved to the desired position. You select how to move them and perform the operation with the "Move" tab.

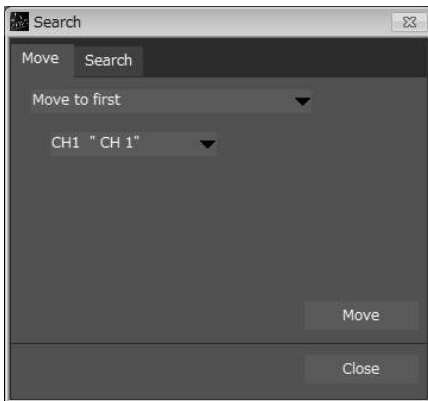

Move to First	Move to the start of the data.
Move to Last	Move to the end of the data.
Move to Trigger Point	Move to a data point where a trigger is generated.
Move to Max	Move to a position of max data for any channel.
Move to Min	Move to a position of min data for any channel.
Move to Specified Point	Move to a specified point from the start.
Move to Elapsed Time	Move to an elapsed time from the start.
Move to Specified Time	Move to a specified time.

During replay, search the level value for the desired channel and move to the resulting position. Search is performed by edge detection. Pressing the display list button will execute an analog search and display the results in a list.

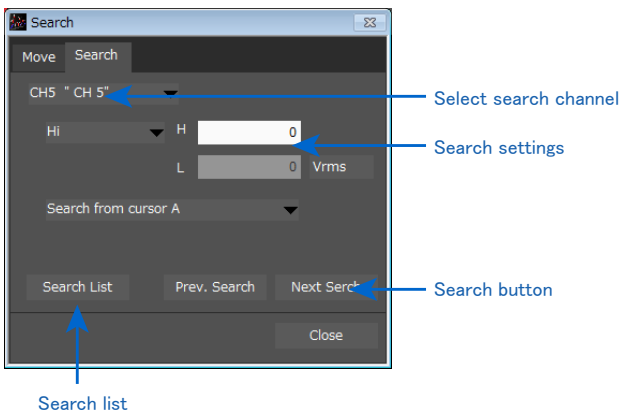

Search list

Executes an analog search and displays the results in a list. Double-click on the list to move to the location where cursor A was found on the waveform display screen.

Press the CSV output button to output, in the form of a CSV file, the list found with the search.

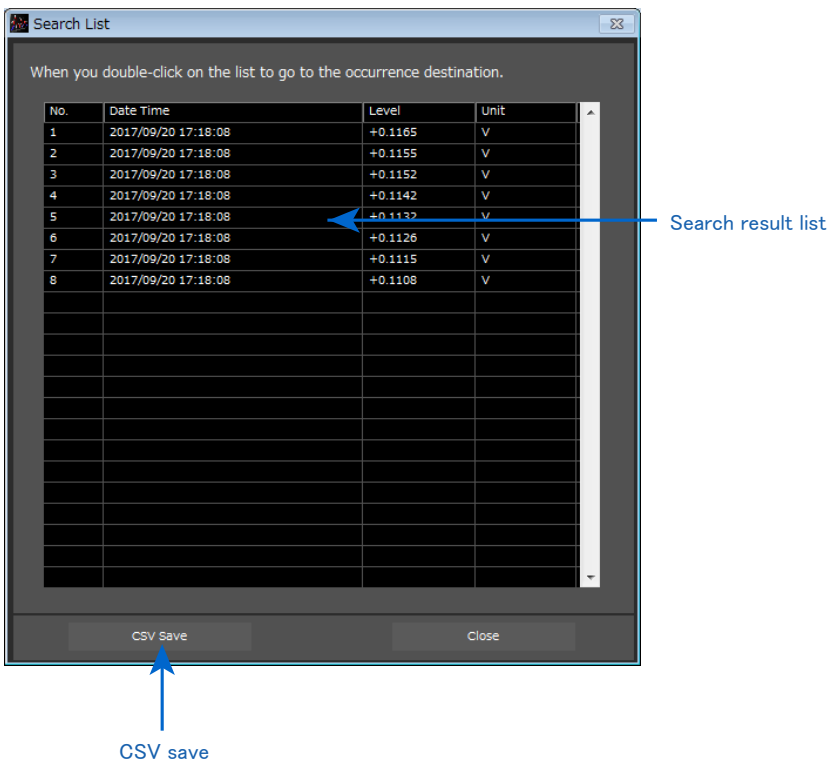

XY

You can select the XY format in the "Wave Switching" to switch to the XY display screen.

Up to four combinations can be handled in the XY display. Any channels can be set.

Behaviors are different between the free running status and the replay status.

During Free Running, the waveforms are always plotted in the XY format for the sampling data.

During Replay, the waveforms are viewed in the XY format for the data within the interval displayed in the scroll bar.

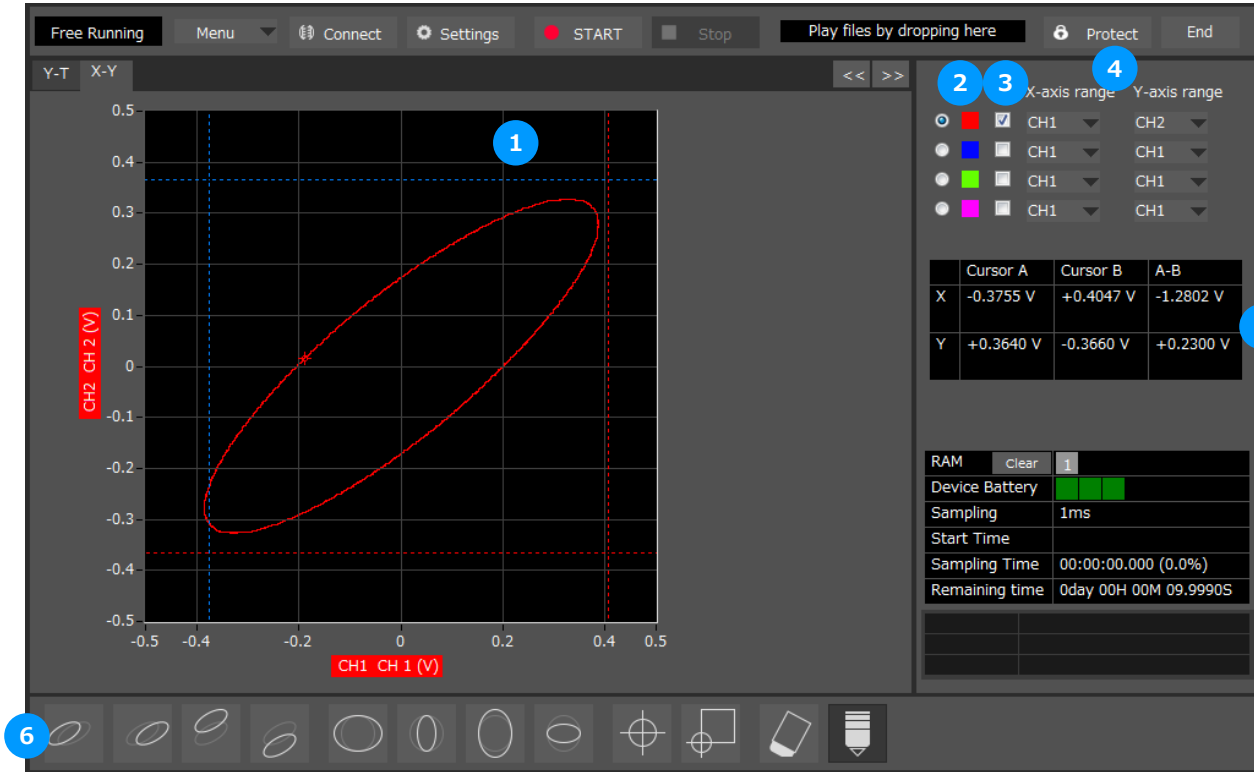

No.	Name	Description
1	XY waveform display	The waveforms are displayed in the XY format.
2	Switch Range	The scale values for the X and Y axes for the lighted channel are displayed.
3	On/Off	Select On/Off for each channel in the XY.
4	X / Y axis CH	Select the channel for the X / Y axis.
5	Cursor Info.	The level value for the cursor in the XY waveform display is displayed.
6	Operation Icons	Click the icon to perform various settings for the waveform display.

Operation Icons



No.	Name	Description
1	Move X axis position	Adjusts the waveform position along the X axis.
2	Expand/reduce X axis	Expands/reduces the waveform along the X axis.
3	Move Y axis position	Adjusts the waveform position along the Y axis.
4	Expand/reduce Y axis	Expands/reduces the waveform along the Y axis.
5	Center origin	Sets the zero-point origin to the center.
6	Lower-left origin	Sets the zero-point origin to the lower-left.
7	Clear waveform	Clears the waveform.
8	Raise/lower pen	Configures whether to raise or lower the pen. When lowered, waveforms will be drawn. The pen will always be lowered at the start of recording.

Replay Screen

This section explains how to replay data that has been captured.

Y-T

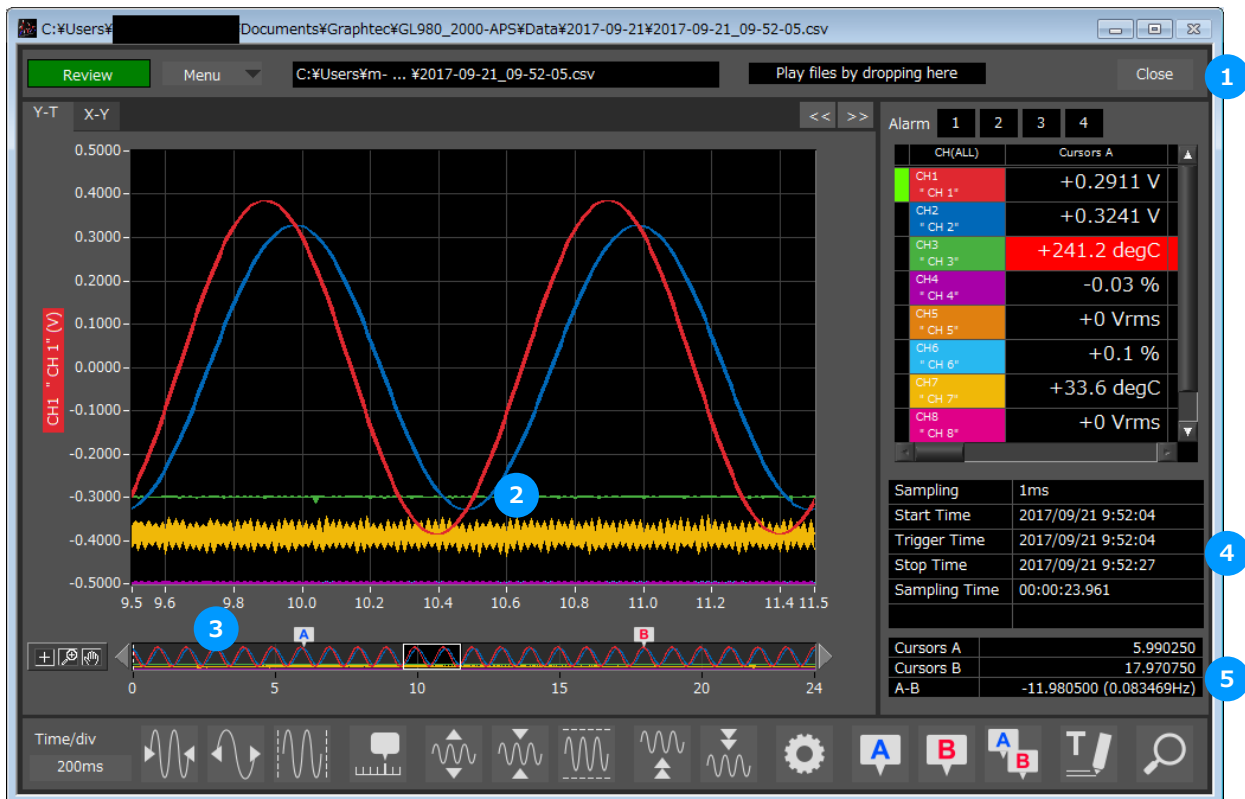

No.	Name	Description								
1	Close	Click this button to close the replay screen.								
2	Waveform Graph	The waveforms are displayed here.								
3	Scroll bar	Moves waveform. Can also move Cursors A and B.								
4	Information	Displays information. <table border="1"> <tbody> <tr> <td>Sampling</td> <td>Displays the sampling interval.</td> </tr> <tr> <td>Start time</td> <td>Displays the recording start time.</td> </tr> <tr> <td>Trigger time</td> <td>Displays the time at which the trigger was detected.</td> </tr> <tr> <td>Stop time</td> <td>Displays the time at which recording was stopped.</td> </tr> </tbody> </table>	Sampling	Displays the sampling interval.	Start time	Displays the recording start time.	Trigger time	Displays the time at which the trigger was detected.	Stop time	Displays the time at which recording was stopped.
Sampling	Displays the sampling interval.									
Start time	Displays the recording start time.									
Trigger time	Displays the time at which the trigger was detected.									
Stop time	Displays the time at which recording was stopped.									
5	Cursor times	Displays the time at cursor A and B and the time difference between A and B.								

Statistical Screen

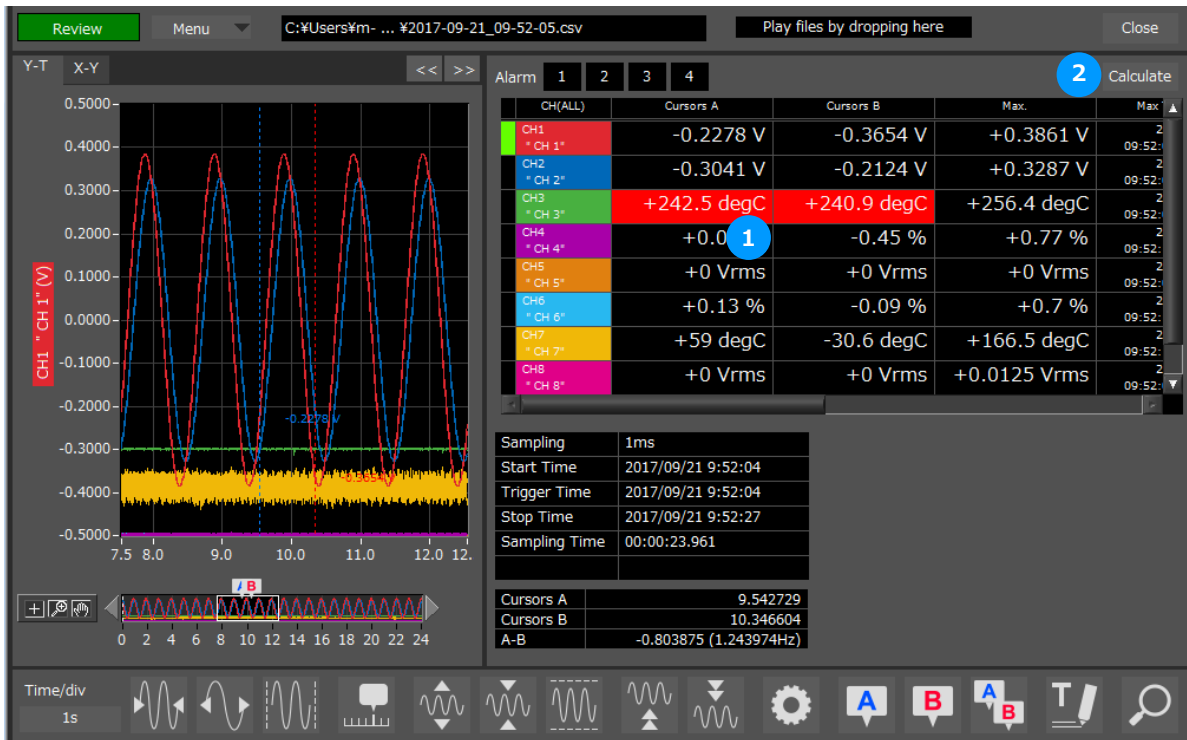

No.	Name	Description												
1	Cursor value Display statistics between cursors	Displays the values and statistical values of the cursor positions. Calculations for statistical values between cursors are executed by pressing the statistics button. <table border="1"> <tbody> <tr> <td>A cursor</td> <td>Displays the level value at the position of cursor A.</td> </tr> <tr> <td>B cursor</td> <td>Displays the level value at the position of cursor B.</td> </tr> <tr> <td>Maximum</td> <td>Displays the maximum value between the cursors.</td> </tr> <tr> <td>Minimum</td> <td>Displays the minimum value between the cursors.</td> </tr> <tr> <td>P-P</td> <td>Displays the P-P value between the cursors.</td> </tr> <tr> <td>Average</td> <td>Displays the average value between the cursors.</td> </tr> </tbody> </table>	A cursor	Displays the level value at the position of cursor A.	B cursor	Displays the level value at the position of cursor B.	Maximum	Displays the maximum value between the cursors.	Minimum	Displays the minimum value between the cursors.	P-P	Displays the P-P value between the cursors.	Average	Displays the average value between the cursors.
A cursor	Displays the level value at the position of cursor A.													
B cursor	Displays the level value at the position of cursor B.													
Maximum	Displays the maximum value between the cursors.													
Minimum	Displays the minimum value between the cursors.													
P-P	Displays the P-P value between the cursors.													
Average	Displays the average value between the cursors.													
2	Execute statistical calculation button	Executes statistical calculations for between the cursors.												

10. Menu

Open PC File

Opens a window for selecting a file that has been recorded on a PC.

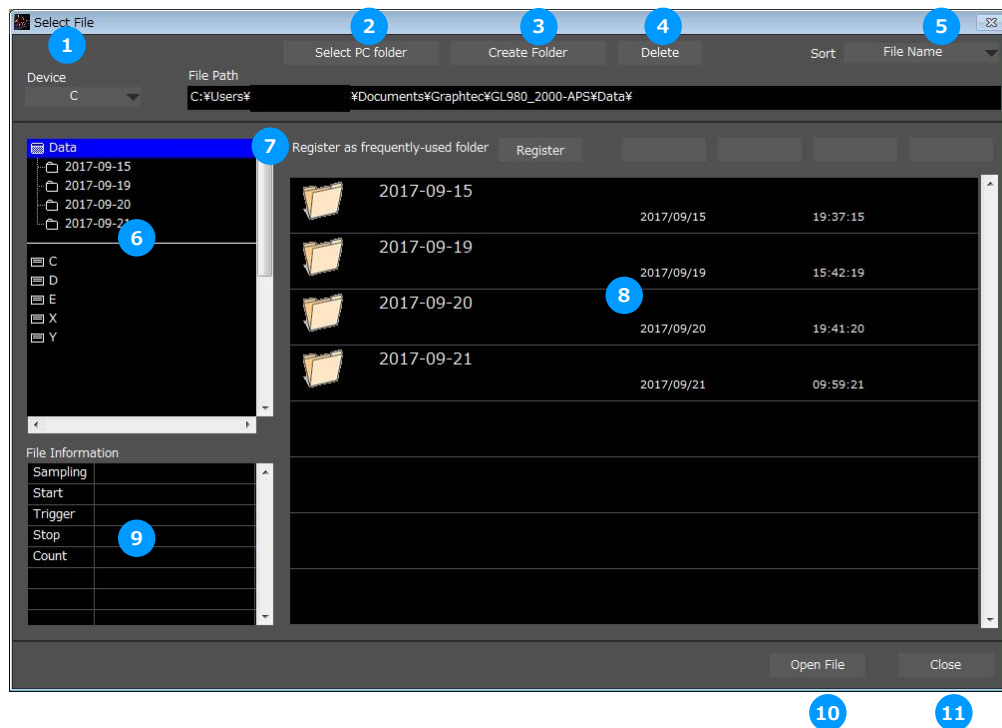

No.	Name	Description
1	Drive	Use this button to select the appropriate PC drive.
2	Select Folder	Click this button to select the folder that has data files.
3	Create Folder	Click this button to create a new folder.
4	Delete	Click this button to delete the selected file.
5	Order	Use this button to select the file arrangement order.
6	File Tree	The hierarchies of the device are displayed in a tree format. The "Data" is the default location to save files in this application. This is the APS folder in the user document folder.
7	Frequently-used folder	Use these buttons to select a frequently-used folder and move the file to that folder. Single click : Select Double click : Move.
8	File List	Files/folders in the current hierarchy are displayed.
9	File Information	When you select binary or text data in the current hierarchy, file information is displayed.
10	Select File	Click this button to select a file (display the file).
11	Cancel	Click this button to cancel the selected file.

Open Device File

Open the eviced file data. Operation is the same as PC file.

File History

Files opened, captured, and converted in the past will be listed as log and can be played.

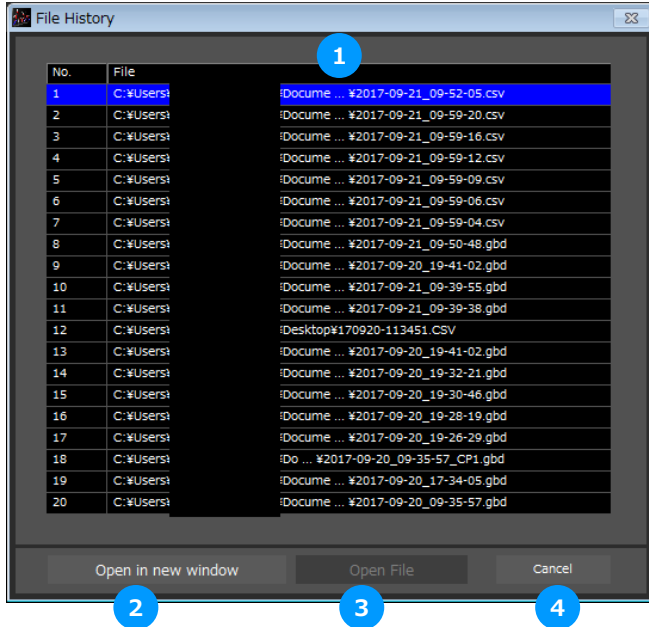

No.	Name	Description
1	Log List	Displays the log list.
2	Open in new window	Opens the file selected in the log list in a new window.
3	Open File	Opens the file selected in the log list.
4	Cancel	Closes the window without any action.

Convert then Save

This function is used to convert replayed data to a different format (GBD, CSV), and to clip and save only the data between the cursors.

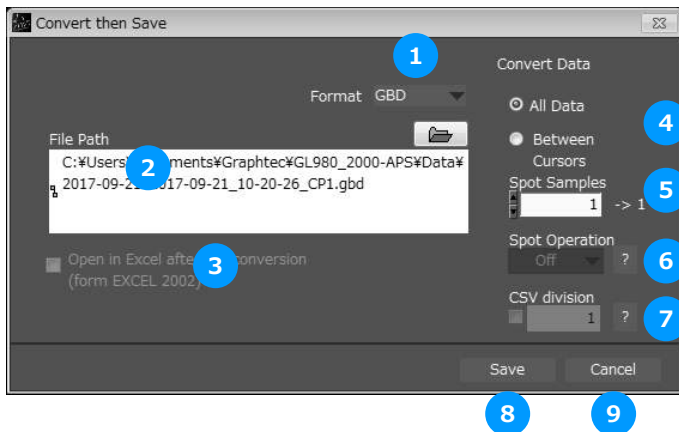

No.	Name	Description		
1	Format	Select a format to convert and save data.		
		<table border="1"> <tr> <td>GBD</td> <td>binary data * CSV data cannot be converted to binary data.</td> </tr> <tr> <td>CSV</td> <td>text data. This is a file format that can be opened with Microsoft's EXCEL and other software.</td> </tr> </table>	GBD	binary data * CSV data cannot be converted to binary data.
GBD	binary data * CSV data cannot be converted to binary data.			
CSV	text data. This is a file format that can be opened with Microsoft's EXCEL and other software.			
2	File Path	Select a location to which you want to save data.		
3	Open with EXCEL after the conversion	<p>If this setting is selected, a file converted into CSV format is opened with EXCEL.</p> <p>* This setting cannot be selected if data is saved in binary format.</p> <p>* EXCEL must be installed to use this function.</p> <p>* This function is not available with EXCEL 2000 or any previous versions.</p>		
4	Select data to be converted	All Data		
		Between Cursor		
5	Spot Samples	<p>Spot samples are extracted when saving data.</p> <p>Ex) 1 → 1 :Spot samples are not extracted.</p> <p>Ex) 2 → 1 :One of two data points is extracted.</p>		
6	Spot Operation	Off		
		Average		
		Maximum		
		Minimum		
7	CSV division	Specifies the number of rows used to split the CSV files when configured to save files in the CSV format.		
8	Save	Executes conversion and saving.		
9	Cancel	Click to close the screen.		

Superimpose/Link

Recorded data can be displayed so that it is layered on top or linked to the waveform screen in relation to data that is being played back.

● Caution

Linking is only possible with files having the same settings (same amplifier settings, same sampling interval)

When changes are saved during overlapped writing, only the first playback file will be saved.

When changes are saved during linked display, the linked data will be saved.

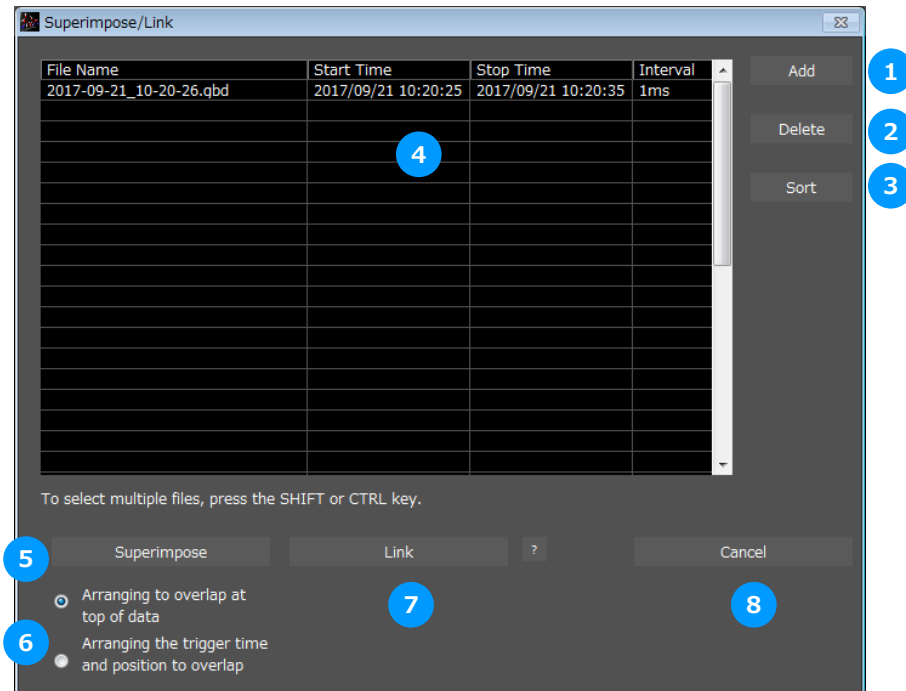

No.	Name	Description				
1	Add	Click this button to add a file to those selected for the superimposing or linking operation. GBD format only support.				
2	Delete	Click this button to delete the added file from the list. With the SHIFT or CTRL key pressed, you can select more than one file.				
3	Sort	Sort files.				
4	File List	The files added to those selected for superimposing or linking are listed here.				
5	Superimpose	Click this button to superimpose files. (* Overlapped data cannot be saved.)				
6	Link method	Select link method <table border="1" style="width: 100%; border-collapse: collapse;"> <tr> <td style="width: 50%; padding: 5px;">Arranging to overlap at top of data</td> <td style="width: 50%; padding: 5px;">Overlapping at top data position</td> </tr> <tr> <td style="width: 50%; padding: 5px;">Arranging the trigger time and position to overlap</td> <td style="width: 50%; padding: 5px;">Overlapping display of trigger time and position. Files with a large time difference cannot be superimposed.</td> </tr> </table>	Arranging to overlap at top of data	Overlapping at top data position	Arranging the trigger time and position to overlap	Overlapping display of trigger time and position. Files with a large time difference cannot be superimposed.
Arranging to overlap at top of data	Overlapping at top data position					
Arranging the trigger time and position to overlap	Overlapping display of trigger time and position. Files with a large time difference cannot be superimposed.					
7	Link	Click this button to link files. * Data with different capture conditions cannot be concatenated. When chain the files, the date and time for chained file is displayed based on the date and time of No. 1 file. Therefore the date and time which are for No. 2 and later files may not be same as actual measurement date and time.				
8	Cancel	Click this button to close the screen.				

CSV File Batch Conversion

This function enables multiple GBD (binary data) files to be converted in a batch to CSV format files.

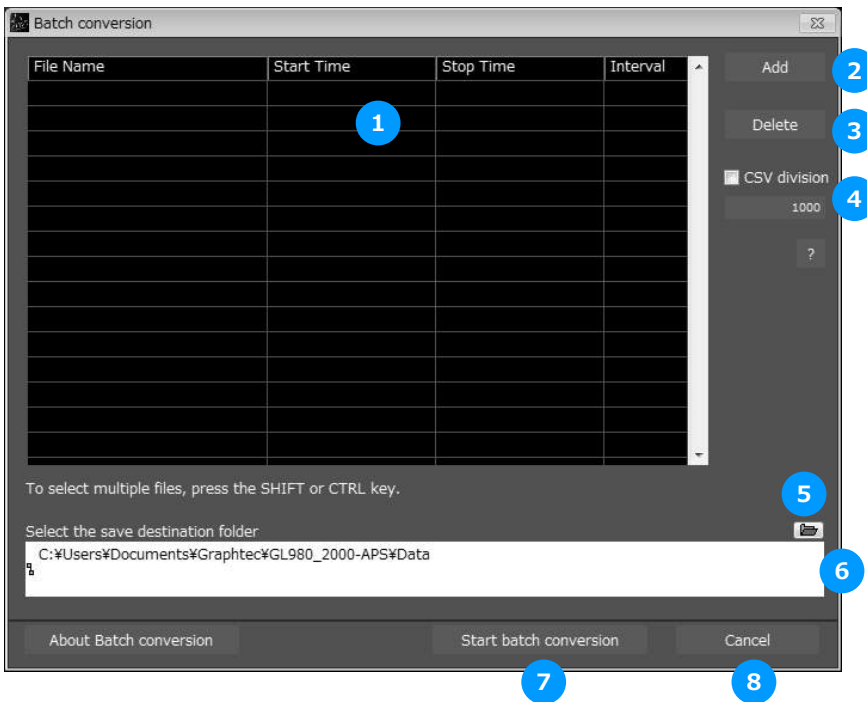

No.	Name	Description
1	List of converted files	The batch-converted files are displayed in a list.
2	Add	Click this button to add a file to the batch to be converted.
3	Delete	Click this button to remove a file from the batch to be converted. With the SHIFT or CTRL key pressed, you can select more than one file.
4	CSV Division	Specifies the number of rows used to split the CSV files.
5	Save destination folder	Select the save destination for the batch-converted files here.
6	Save folder path	Displays the path of the save folder.
7	Start batch conversion	Click this button to start batch file conversion.
8	Cancel	Click this button to cancel the batch conversion operation and close the screen.

Print Screen

Prints the display screen on the printer. Printing is performed at the printer that has been selected as the default printer. If you change the printer, relaunch the software.

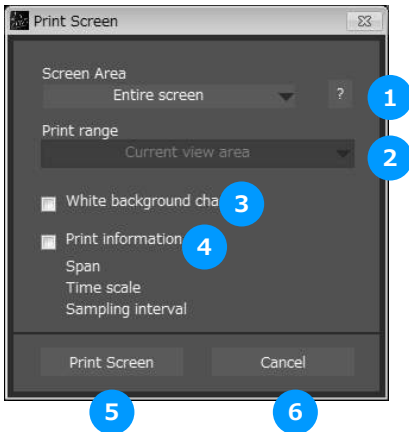

No.	Name	Description		
1	Screen range	Select a screen range to be printed.		
		<table border="1"> <tr> <td>Entire screen</td> <td>Prints all of the displayed screen.</td> </tr> <tr> <td>Waveform only</td> <td>Prints only the waveform graph.</td> </tr> </table>	Entire screen	Prints all of the displayed screen.
Entire screen	Prints all of the displayed screen.			
Waveform only	Prints only the waveform graph.			
2	Print range	Selects a range to be printed. * Selection is available when the scroll is Off during capture, or during data replay.		
		<table border="1"> <tr> <td>Current view area</td> <td>Prints the current view area.</td> </tr> <tr> <td>Between the cursor A and B</td> <td>Prints data between Cursors A and B in the time scale in which it is displayed. If the range is too large, data is printed on more than one sheet.</td> </tr> </table>	Current view area	Prints the current view area.
Current view area	Prints the current view area.			
Between the cursor A and B	Prints data between Cursors A and B in the time scale in which it is displayed. If the range is too large, data is printed on more than one sheet.			
3	White background chart	Prints the waveform graph against a white background.		
4	Print information	Prints the graph with information in it. The information to be printed is the span, Time/DIV, and sampling interval. Not all the channel information may be included depending on the number of channels to be displayed.		
5	Print	Starts printing.		
6	Cancel	Cancels printing.		

Save Screen

To save the displayed screen as a PNG file.

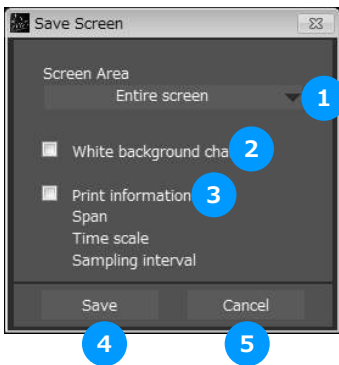

No.	Name	Description	
1	Screen range	Selects a range of the screen to be saved in PNG.	
		Entire screen	Saves all the displayed screen in PNG.
		Waveform only	Saves only the waveform graph in PNG.
3	White background chart	Saves the waveform graph against a white background in PNG.	
4	Print information	Saves the graph with information displayed in it in PNG. The information to be displayed is the span, Time/DIV, and sampling interval. * Not all the channel information may be included depending on the number of channels to be displayed.	
5	Save	Starts saving the screen in PNG.	
6	Cancel	Cancels saving the screen.	

Language Settings

Switch the displayed language. It will be necessary to reactivate this software in order for the configuration to be reflected. Since garbled occurs, please use the OS of the corresponding language.

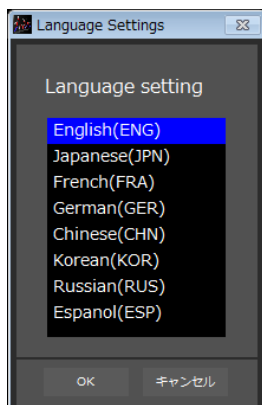

11. Settings Screens

This chapter describes the screens used to perform settings related to data capture.

AMP Settings

This screen is used to make the analog input, logic input, and pulse input settings.

*Screen of the GL980 model



No.	Name	Description	
1	Settings tabs	These tabs are used to change the settings screen.	
		AMP Settings	This tab is used to make input-related settings.
		Data Capture Settings	This tab used to make settings related to data capture.
		Trigger/Alarm Settings	This tab is used to make settings related to the trigger and alarm functions.
		Other Settings	This tab is used to make various other settings, to display information, and so forth.
2	CH	These are the channel numbers for analog input.	
3	Color	The color used for the waveform for each channel can be specified here. * Color settings are the setting values for the software and a different color may be shown during recording and playing.	
4	Annotation	Each channel can be freely annotated (input the signal name, etc.). The maximum number of characters is 31 (in single-byte). *Annotation settings cannot be stored in recorded data. Since such settings are a setting value on the software, they may differ during recording and playing operations.	
5	Input	Setting contents will differ by each model and sensor. Refer to the instruction manual for details of each models.	
6	Range	Setting contents will differ by each model and sensor. Refer to the instruction manual for details of each models.	

No.	Name	Description						
7	Filter	Use these buttons to set the filter for each channel. Refer to the instruction manual for details of each models.						
8	Unit	The selected unit is displayed here.						
9	Span	Use these buttons to set the upper limit and lower limit values for the waveforms displayed in the waveform graph.						
10	EU	Use these buttons to convert the unit.						
11	Adjust	Adjust at each input.						
12	Logic/Pulse switching	Use this button to switch the digital input. Logic, Pulse, or OFF can be set here. (Off/Pulse/Logic)						
13	Logic / Pulse CH number	The channel numbers for logic or pulse input.						
14	Logic / Pulse Line Color	Make the logic or pulse line color setting here.						
15	Logic / Pulse Annotation	Each channel can be freely annotated (input the signal name, etc.). The maximum number of characters is 31 (in single-byte).						
16	Pulse Input	Use the Input button to select the pulse input type. <table border="1" data-bbox="523 775 1398 958"> <tr> <td>Revolutions</td> <td>The number of pulses generated in sampling interval, and displayed as the number of revolutions (RPM).</td> </tr> <tr> <td>Counts</td> <td>A cumulative count is made of the number of pulses generated in one sample.</td> </tr> <tr> <td>Inst.</td> <td>The number of pulses generated in one sample is counted.</td> </tr> </table>	Revolutions	The number of pulses generated in sampling interval, and displayed as the number of revolutions (RPM).	Counts	A cumulative count is made of the number of pulses generated in one sample.	Inst.	The number of pulses generated in one sample is counted.
Revolutions	The number of pulses generated in sampling interval, and displayed as the number of revolutions (RPM).							
Counts	A cumulative count is made of the number of pulses generated in one sample.							
Inst.	The number of pulses generated in one sample is counted.							
17	Pulse Filter	Make the pulse filter setting here. (Off/On)						
18	Pulse Slope	Use this button to select the pulse detection slope. <table border="1" data-bbox="523 1043 1398 1124"> <tr> <td>H</td> <td>Rising signals are counted.</td> </tr> <tr> <td>L</td> <td>Falling signals are counted.</td> </tr> </table>	H	Rising signals are counted.	L	Falling signals are counted.		
H	Rising signals are counted.							
L	Falling signals are counted.							
19	Pulse Span	Use this button to set the upper limit and lower limit values for the waveforms displayed in the waveform graph.						
20	Pulse EU	Use this button to convert the unit.						
21	Pulses per revolution	Set the pulses per revolution. Only valid when the input is "Revolutions".						
22	Graph Display	The waveforms for which settings have been made can be checked here. Click the "Apply" button to apply the settings that have been made.						
23	OK	Click this button to register your settings and close the screen.						
24	Cancel	Click this button to close the screen without registering your settings.						
25	Apply	Click this button to apply the settings mode.						

Span Settings

Span settings are made at this screen.

To make the settings, input numerical values directly or use a cursor to adjust values.

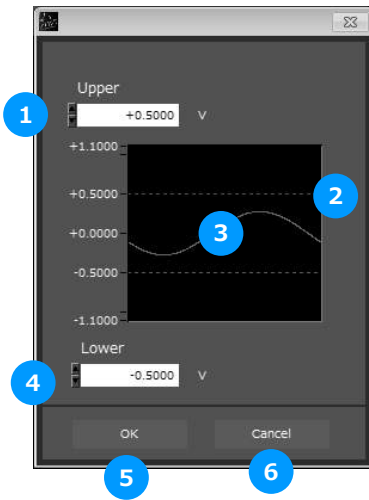

No.	Name	Description
1	Upper limit value input	Inputs the upper limit value.
2	Cursor selection range	Specifies the span range with the cursors on the top and bottom.
3	Input waveform	Displays the input waveform.
4	Lower limit value input	Inputs the lower limit value.
5	OK	Confirms the setting.
6	Cancel	Closes the screen without setting.

EU Settings

Sets the EU (Engineer Unit). Enter the upper and lower limits of the input and converted values. For the temperature channel, the offset setting with two points is used.

* If you have changed the input from the temperature or voltage just before retrieving the temperature measurement values, first click "Apply" in the capture setting screen.

*Polarity reversal setting does not correspond.

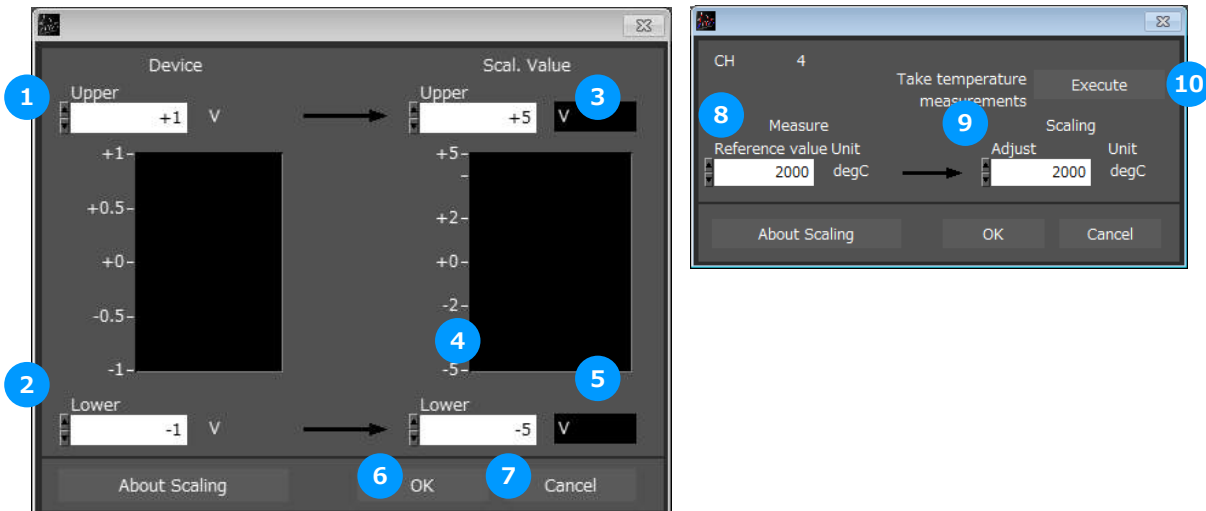

No.	Name	Description
1	Input side upper limit value input	Inputs the upper limit value for the input side.
2	Input side lower limit value input	Inputs the lower limit value for the input side.
3	EU side upper limit input	Inputs the upper limit value for the EU side.
4	EU side lower limit value input	Inputs the lower limit value for the EU side.
5	EU side units	Configures the units for the EU side. Up to 8 single-byte characters.
6	OK	Confirms the settings and closes the screen.
7	Cancel	Closes the screen without setting.
8	Input side numerical value input	Inputs the numerical value for the input side.
9	EU side numerical value input	Inputs the numerical value for the EU side.
10	Import measured temperature value	Imports the measured current temperature value to the input side.

Adjustment settings

Performs adjustments depending on each input.

When voltage is configured: Zero-point adjustment

Automatically adjusts the input value to the zero position.

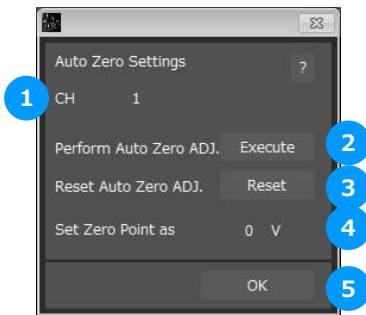

No.	Name	Description
1	CH	The CH number for the analog input.
2	Perform Auto Zero ADJ.	Executes zero-point adjustment.
3	Reset Auto Zero ADJ.	Resets the zero-point adjustment value.
4	Set Zero Point as	Displays the offset value adjusted with zero-point adjustment.
5	OK	Closes the screen.

When root mean square value is adjusted: Zero cross adjustment

Configures the threshold value for detecting a single cycle of the input signal when a root mean square value has been set.

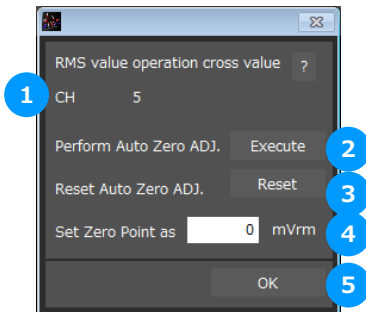

No.	Name	Description
1	CH	The CH number for the analog input.
2	Execute zero cross value adjustment	Automatically configures the threshold value for detecting a single cycle.
3	Reset	Resets the adjustment value.
4	Adjustment value settings	Displays the automatic adjustment value. Adjustments can also be made by manual input.
5	OK	Closes the screen.

Data Capture Settings

Settings such as the Sampling Interval, Device Capture Settings and PC Capture Settings are made at this screen.

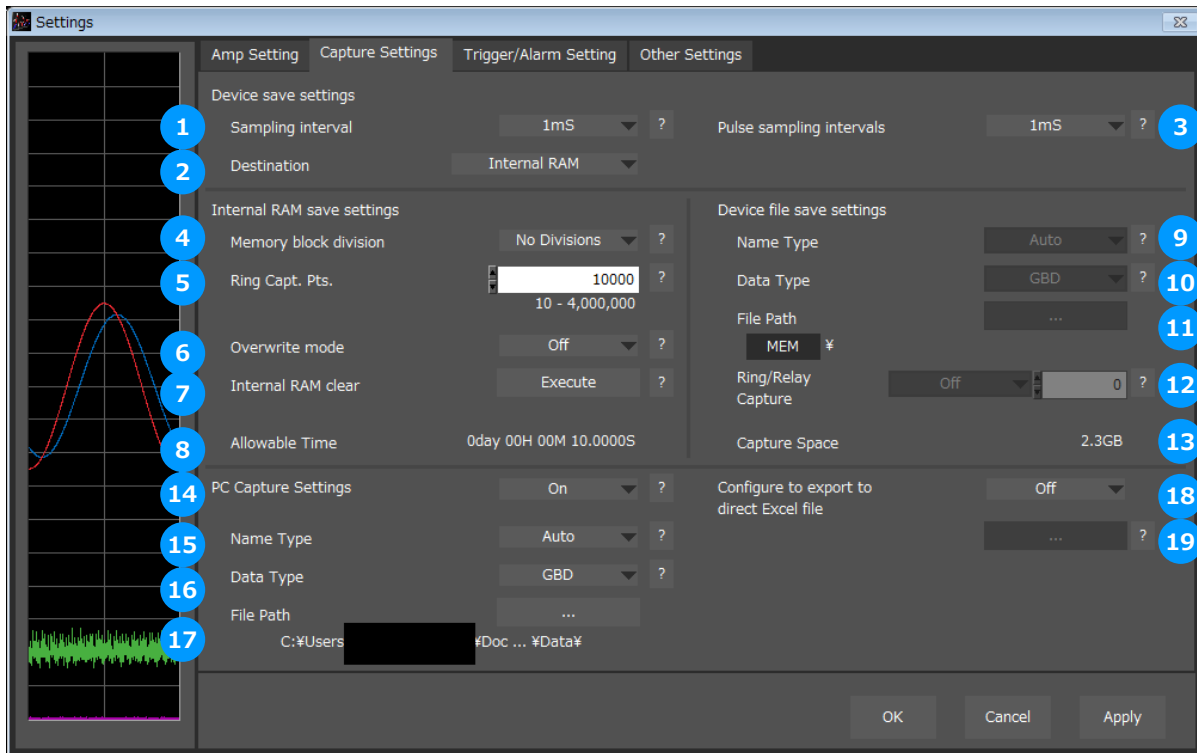

No.	Name	Description						
1	Sampling Interval	<p>Configures the interval for recording data. The setting will differ depending on the where in the main unit the recording is being saved.</p> <table border="1"> <tr> <td>Internal RAM</td> <td>1/2/5/10/20/50/100/200/500(us)/1/2/5/10/20/50/100/200/500(ms)/1/2/5/10/20/30(s)/1(min)/Ext</td> </tr> <tr> <td>Int. Flash/SDcard/USB Memory</td> <td>1/2/5/10/20/50/100/200/500(ms)/1/2/5/10/20/30(s)/1(min)/Ext *The fastest speed will be limited to 10ms under the following conditions when the CSV format is selected. When ring recording is enabled / When relay recording is enabled</td> </tr> </table>	Internal RAM	1/2/5/10/20/50/100/200/500(us)/1/2/5/10/20/50/100/200/500(ms)/1/2/5/10/20/30(s)/1(min)/Ext	Int. Flash/SDcard/USB Memory	1/2/5/10/20/50/100/200/500(ms)/1/2/5/10/20/30(s)/1(min)/Ext *The fastest speed will be limited to 10ms under the following conditions when the CSV format is selected. When ring recording is enabled / When relay recording is enabled		
Internal RAM	1/2/5/10/20/50/100/200/500(us)/1/2/5/10/20/50/100/200/500(ms)/1/2/5/10/20/30(s)/1(min)/Ext							
Int. Flash/SDcard/USB Memory	1/2/5/10/20/50/100/200/500(ms)/1/2/5/10/20/30(s)/1(min)/Ext *The fastest speed will be limited to 10ms under the following conditions when the CSV format is selected. When ring recording is enabled / When relay recording is enabled							
2	Capture des.	<p>Set the device data capture destination.</p> <table border="1"> <tr> <td>Off</td> <td>Recording of the main unit will not be performed. Used when mainly recording with a PC only.</td> </tr> <tr> <td>Internal RAM</td> <td>A media with which data is erased when the power of the main unit is turned off. When PC recording is set to On, data will be transferred to the PC at the same time as the recording on the internal RAM. If the recording speed is faster than the transfer of data to the PC, the transfer of data will continue even after the recording on the internal RAM has ended.</td> </tr> <tr> <td>Int. Flash/SDcard/USB Memory</td> <td>Recording will be performed on one of the media. The data file will remain even if the power of the main unit is turned off.</td> </tr> </table>	Off	Recording of the main unit will not be performed. Used when mainly recording with a PC only.	Internal RAM	A media with which data is erased when the power of the main unit is turned off. When PC recording is set to On, data will be transferred to the PC at the same time as the recording on the internal RAM. If the recording speed is faster than the transfer of data to the PC, the transfer of data will continue even after the recording on the internal RAM has ended.	Int. Flash/SDcard/USB Memory	Recording will be performed on one of the media. The data file will remain even if the power of the main unit is turned off.
Off	Recording of the main unit will not be performed. Used when mainly recording with a PC only.							
Internal RAM	A media with which data is erased when the power of the main unit is turned off. When PC recording is set to On, data will be transferred to the PC at the same time as the recording on the internal RAM. If the recording speed is faster than the transfer of data to the PC, the transfer of data will continue even after the recording on the internal RAM has ended.							
Int. Flash/SDcard/USB Memory	Recording will be performed on one of the media. The data file will remain even if the power of the main unit is turned off.							
3	Pulse Sampling	<p>When pulses are enabled, it is possible to configure the sampling of pulses separately from the sampling. Pulse sampling must be in a range that is slower than the sampling while also being a multiple of the sampling value.</p>						

No.	Name	Description						
4	Memory Block Division	When an internal RAM is configured, the internal RAM can be split to perform multiple recordings. Number of splits: No splits / 2 splits / 4 splits / 8 splits *When split, the number of data points that can be recorded will decrease. (1/8 with 8 splits) *Switching the memory block split will clear all of the internal RAM recording data.						
5	Data Points	Set the number of points to record during internal RAM setting.						
6	Overwrite mode	When set to ON when internal RAM is configured, recording will be performed by overwriting the blocks that have already been used for recording. When set to Off, overwriting recording will not be performed.						
7	Internal RAM Clear	When internal RAM is configured, all blocks that have already been used for recording will be cleared.						
8	Allowable capture time	The length of time available for data capture to the selected device storage medium is displayed here.						
9	Name Type	Use this button to select the method for appending the file name . <table border="1"> <tr> <td>Auto</td> <td>Create a date folder in the specified folder, and then create a date and time file in it. (Example: 171001-123456.GBD)</td> </tr> <tr> <td>User</td> <td>The file name can be freely specified by the user.</td> </tr> <tr> <td>Serial</td> <td>Adds a number that increases with each recording to the end of any name of choice.</td> </tr> </table>	Auto	Create a date folder in the specified folder, and then create a date and time file in it. (Example: 171001-123456.GBD)	User	The file name can be freely specified by the user.	Serial	Adds a number that increases with each recording to the end of any name of choice.
Auto	Create a date folder in the specified folder, and then create a date and time file in it. (Example: 171001-123456.GBD)							
User	The file name can be freely specified by the user.							
Serial	Adds a number that increases with each recording to the end of any name of choice.							
10	Data Format	Use this button to select the format of the data saved to the device. <table border="1"> <tr> <td>Binary format (GBD)</td> <td>The data is saved as binary data. When compared with a CSV file, the file size is somewhat small.</td> </tr> <tr> <td>Text format (CSV)</td> <td>The data is saved as text data in a format that can be displayed in Excel.</td> </tr> </table>	Binary format (GBD)	The data is saved as binary data. When compared with a CSV file, the file size is somewhat small.	Text format (CSV)	The data is saved as text data in a format that can be displayed in Excel.		
Binary format (GBD)	The data is saved as binary data. When compared with a CSV file, the file size is somewhat small.							
Text format (CSV)	The data is saved as text data in a format that can be displayed in Excel.							
11	Save Path	The save destination at the device for the captured data is selected here.						
12	Ring/Relay Capture	<table border="1"> <tr> <td>Ring recording</td> <td>A function used to record while erasing old data when a configured number of recordings is exceeded.</td> </tr> <tr> <td>Relay recording</td> <td>Continuously records while splitting files based on a chosen size or amount of time.</td> </tr> </table>	Ring recording	A function used to record while erasing old data when a configured number of recordings is exceeded.	Relay recording	Continuously records while splitting files based on a chosen size or amount of time.		
Ring recording	A function used to record while erasing old data when a configured number of recordings is exceeded.							
Relay recording	Continuously records while splitting files based on a chosen size or amount of time.							
13	Capture Space	The amount of capacity available for data capture at the device is displayed.						
14	PC measure settings	Configures the On/Off of recording on the PC side.						
15	Name Type	Use this button to select the method for appending the file name . <table border="1"> <tr> <td>Auto</td> <td>Create a date folder in the specified folder, and then create a date and time file in it. (Example: 2017-10-01_12-34-56.GBD)</td> </tr> <tr> <td>User</td> <td>The file name can be freely specified by the user.</td> </tr> <tr> <td>Serial</td> <td>Adds a number that increases with each recording to the end of any name of choice.</td> </tr> </table>	Auto	Create a date folder in the specified folder, and then create a date and time file in it. (Example: 2017-10-01_12-34-56.GBD)	User	The file name can be freely specified by the user.	Serial	Adds a number that increases with each recording to the end of any name of choice.
Auto	Create a date folder in the specified folder, and then create a date and time file in it. (Example: 2017-10-01_12-34-56.GBD)							
User	The file name can be freely specified by the user.							
Serial	Adds a number that increases with each recording to the end of any name of choice.							
16	Data Format	Use this button to select the format of the data saved to the device (personal computer). <table border="1"> <tr> <td>Binary format (GBD)</td> <td>The data is saved as binary data. When compared with a CSV file, the file size is somewhat small.</td> </tr> <tr> <td>Text format (CSV)</td> <td>The data is saved as text data in a format that can be displayed in Excel.</td> </tr> </table>	Binary format (GBD)	The data is saved as binary data. When compared with a CSV file, the file size is somewhat small.	Text format (CSV)	The data is saved as text data in a format that can be displayed in Excel.		
Binary format (GBD)	The data is saved as binary data. When compared with a CSV file, the file size is somewhat small.							
Text format (CSV)	The data is saved as text data in a format that can be displayed in Excel.							
17	Save Path	The save destination at the PC (personal computer) for the captured data is selected here.						
18	Direct Excel settings	A function for transferring data to EXCEL in real time while recording. This can be used to create reports upon creating an original template file. <table border="1"> <tr> <td>Off</td> <td>Uses the direct EXCEL function.</td> </tr> <tr> <td>On</td> <td>Does not use the direct EXCEL function.</td> </tr> </table>	Off	Uses the direct EXCEL function.	On	Does not use the direct EXCEL function.		
Off	Uses the direct EXCEL function.							
On	Does not use the direct EXCEL function.							

Review Device Settings

Set the save destination screen on the main unit side.

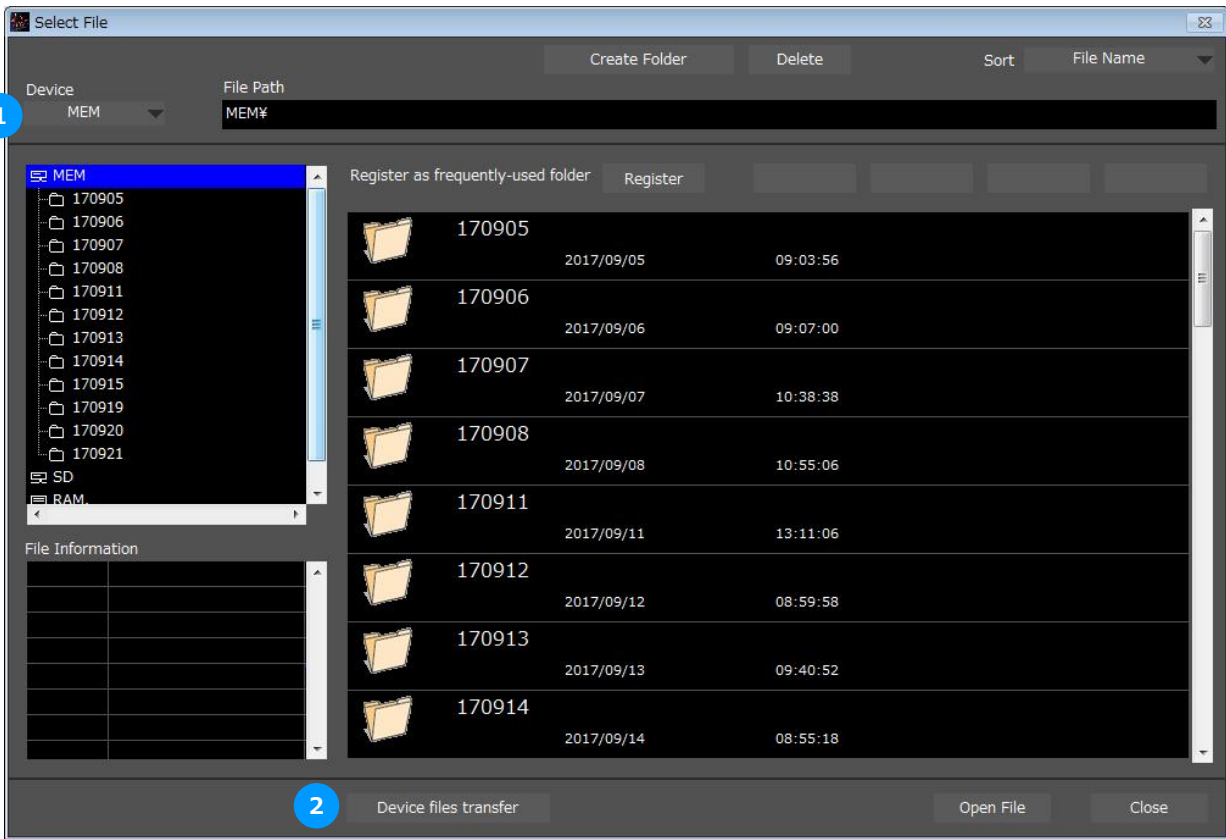

No.	Name	Description
1	Device	Use this button to select the appropriate device drive.
2	Device Files Transfer	The files in the device will be transferred to the PC. Multiple files can be transferred.

PC Capture Settings

When setting where to save on the PC side, the screen will be similar to the screen for setting where to save on the main unit side.

Direct EXCEL Settings

A function for transferring data to EXCEL in real time while recording. This can be used to create reports upon creating an original template file.

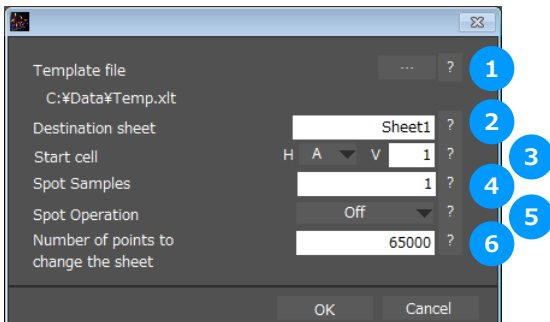

No.	Name	Description								
1	Template file	The template file settings for the Export to Direct Excel File function are made here. Files with the ".xlt" and ".xls" extensions can be used. Template files are provided as standard in the "Temp" folder that is installed with this software.								
2	Destination sheet	This parameter is used to specify the name of the specified temp late sheet.								
3	Start cell	This parameter is used to specify the start position on the sheet from which to transfer data.								
4	Spot Samples	Configures the interval for drawing out the data. Any value between 1 - 1000000 can be configured.								
5	Spot Operation	Configures the interpolation processing of data that is drawn out when the draw out interval is set to 2 or above. <table border="1" data-bbox="528 981 1406 1144"> <tbody> <tr> <td>Off</td> <td>Draws out data without interpolation.</td> </tr> <tr> <td>Average</td> <td>Interpolates the drawn out data to the average value.</td> </tr> <tr> <td>Maximun</td> <td>Interpolates the drawn out data to the maximum value.</td> </tr> <tr> <td>Minimum</td> <td>Interpolates the drawn out data to the minimum value.</td> </tr> </tbody> </table>	Off	Draws out data without interpolation.	Average	Interpolates the drawn out data to the average value.	Maximun	Interpolates the drawn out data to the maximum value.	Minimum	Interpolates the drawn out data to the minimum value.
Off	Draws out data without interpolation.									
Average	Interpolates the drawn out data to the average value.									
Maximun	Interpolates the drawn out data to the maximum value.									
Minimum	Interpolates the drawn out data to the minimum value.									
6	Number of points to change the sheet	When the specified number of points is reached, data is transferred to a different sheet. * When data is transferred to a different sheet, the graph or other element may not work correctly. * EXCEL versions before 2007: Supports display up to Row 65536. * EXCEL 2007 and later versions: Supports display up to Row 1048576. * Transfer of 32000 points or more is disabled if a graph is used in the template.								

Trigger/Alarm Settings

Settings such as the trigger start condition, stop condition, alarm settings.

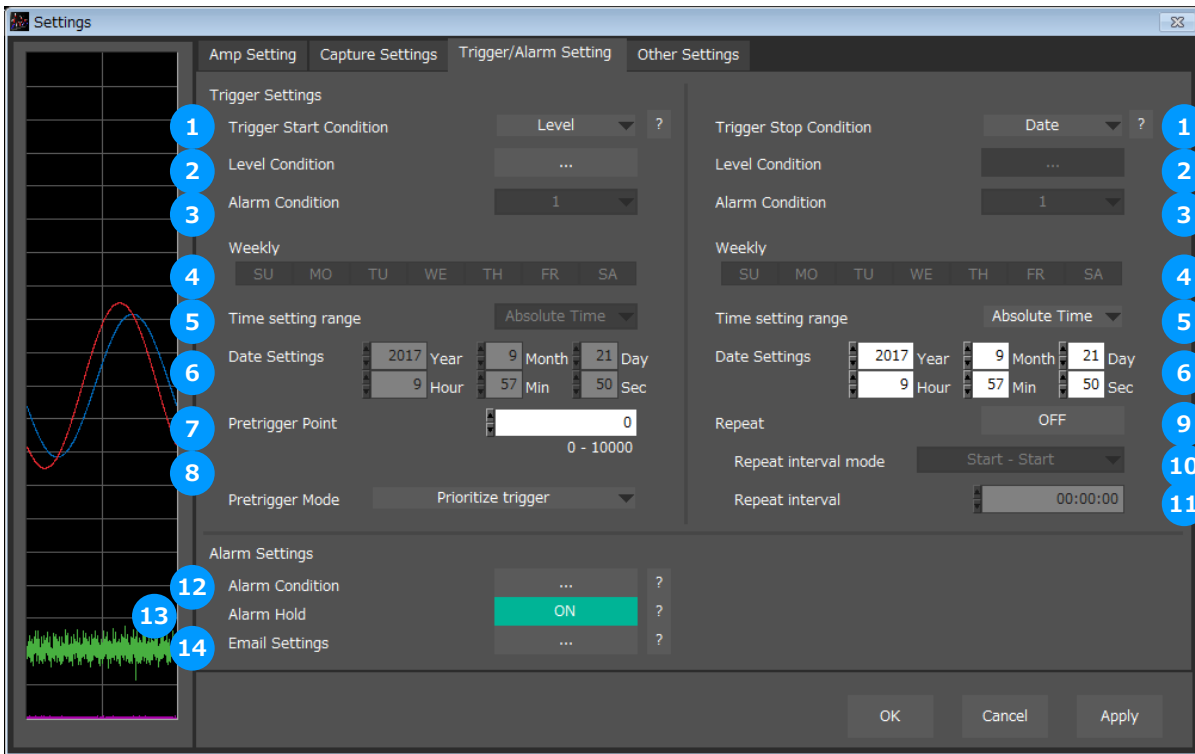

No.	Name	Description	
1	Trigger Selection	Use this button to select the trigger start(stop) condition.	
		Off	There is no data capture start condition. (There is no stop condition.)
		Level	Data capture starts(stops) when the desired channel reaches the specified level value.
		Alarm	Data capture starts(stops) when the specified alarm occurs.
		Date	Data capture starts(stops) at the specified date and time. * Settings are available only if Repeated Capture is Off. * Settings are not transmitted to or received from this unit.
		Week	Starts (stops) capture when the specified day of the week arrives.
		External	Data capture starts(stops) with the external terminal signal. Data capture starts when the external trigger signal detects a falling of about 2.5V or less.
	Defined Time	Starts (stops) capture when a specified length of time elapses.	
2	Level Condition	If "Level" has been selected for the start(stop) condition, make the required level settings here.	
3	Alarm Condition	If "Alarm" has been selected for the trigger start(stop) condition, set the alarm number here. Select an alarm number 1/2/3/4.	
4	Week Settings	Sets the day of the week when the trigger start (stop) condition is "Week."	

No.	Name	Description	
5	Time setting range	The configured range of time can be changed.	
		Absolute time	Configures the time with the year, month, day, hour, minute, and seconds.
		Year	Configures the time with the month, day, hour, minute, and seconds.
		Month	Configures the time with the day, hour, minute, and seconds.
		Day	Configures the time with the hour, minute, and seconds.
		Hour	Configures the time with the minute and seconds.
		Min	Configures the time with the seconds.
6	Date Settings	Sets the Date for starting (stopping) the capture on a specified day of the week when the trigger start (stop) condition is "Date" and "Week".	
7	Pretrigger	Data is captured before a start trigger is generated. It specifies the percentage of data points to be captured. To use this function, you must set "Trigger Start" to other than "Off". This can be used only when the device data capture destination is set to the internal RAM.	
8	Pretrigger mode	Configures the condition for the Pretrigger.	
		Prioritize trigger	Triggers that occurred during pre-trigger recording are accepted.
		Priority for pretrigger recording	Triggers will not be accepted until the specified number of pretriggers can be recorded.
9	Repeat	If On has been selected, the device proceeds to perform the next data capture operation after a start(stop) trigger has been generated. * Does not transmit or receive the settings to or from this unit. This unit is always Off and the file name does not include "REP."	
		Off	Data capture is not repeated.
		On	After a stop trigger has been generated, or after all data points in the internal RAM has been captured, the next data capture starts. If the capture destination is not the internal RAM, you must set "Trigger Stop" to other than "Off".
10	Repeat mode	Configures the condition for the repeat interval.	
		Start - Start	Configures the interval from the start of recording to the start of the next recording.
		Stop - Start	Configures the interval from the stop of recording to the start of the next recording.
11	Repeat interval	Set the repeat interval time.	
12	Alarm Condition	Use this button to make the alarm level settings for each input.	
13	Alarm Hold	This parameter specifies whether to maintain or clear the alarm status.	
14	Email Settings	Performs settings for sending a mail when an alarm is generated.	

CHECKPOINT

When the sampling is set to the External, the start trigger and the stop trigger cannot be set to the external at the same time. Also when the start trigger or the stop trigger is set to the External, if the sampling is set to the External, the start trigger or the stop trigger is force set to Off.

Trigger Level Condition

If "Level" has been selected for the Trigger setting, the "Trigger Start/Stop Condition" settings must be made.

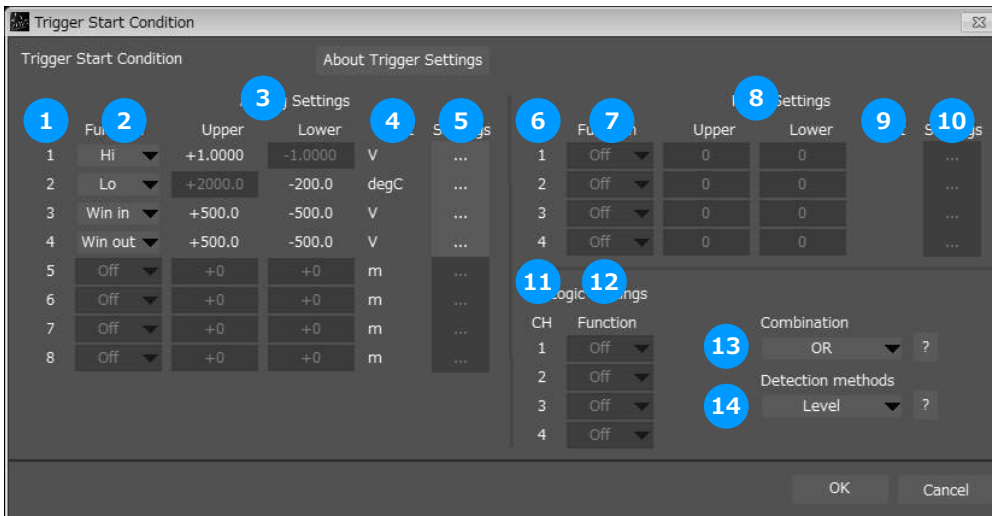

No.	Name	Description										
1	CH	The channel numbers are displayed here.										
2	Function	Use this button to select the trigger level detection mode. <table border="1"> <tr> <td>Off</td> <td>Disabled</td> </tr> <tr> <td>Hi</td> <td>A trigger is generated if the input signal is above the specified level.</td> </tr> <tr> <td>Lo</td> <td>A trigger is generated if the input signal is below the specified level.</td> </tr> <tr> <td>WinIn</td> <td>A trigger is generated if the input signal comes between the specified levels.</td> </tr> <tr> <td>WinOut</td> <td>A trigger is generated if the input signal goes outside the specified levels.</td> </tr> </table>	Off	Disabled	Hi	A trigger is generated if the input signal is above the specified level.	Lo	A trigger is generated if the input signal is below the specified level.	WinIn	A trigger is generated if the input signal comes between the specified levels.	WinOut	A trigger is generated if the input signal goes outside the specified levels.
Off	Disabled											
Hi	A trigger is generated if the input signal is above the specified level.											
Lo	A trigger is generated if the input signal is below the specified level.											
WinIn	A trigger is generated if the input signal comes between the specified levels.											
WinOut	A trigger is generated if the input signal goes outside the specified levels.											
3	Upper/Lower	The level settings are displayed here.										
4	Unit	The unit is displayed here.										
5	Setting	Click this button to make the level settings.										
6	Pulse CH	The channel numbers for pulses are displayed here.										
7	Pulse Function	Use this button to select the pulse level detection mode. (Same as Analog)										
8	Pulse Upper/Lower	The level settings are displayed here.										
9	Pulse Unit	The unit is displayed here.										
10	Pulse Settings	Click this button to make the pulse settings.										
11	Logic CH	The channel numbers for logics are displayed here.										
12	Logic Function	Use this button to select the logic setting. <table border="1"> <tr> <td>X</td> <td>Disabled</td> </tr> <tr> <td>H</td> <td>Detection is performed when the signal is rising.</td> </tr> <tr> <td>L</td> <td>Detection is performed when the signal is falling.</td> </tr> </table>	X	Disabled	H	Detection is performed when the signal is rising.	L	Detection is performed when the signal is falling.				
X	Disabled											
H	Detection is performed when the signal is rising.											
L	Detection is performed when the signal is falling.											
13	Combination	Use this button to set the combination of configured triggers. <table border="1"> <tr> <td>OR</td> <td>Data capture starts (stops) when one of the configured trigger conditions is true.</td> </tr> <tr> <td>AND</td> <td>Data capture starts (stops) when all of the configured trigger conditions are true.</td> </tr> </table>	OR	Data capture starts (stops) when one of the configured trigger conditions is true.	AND	Data capture starts (stops) when all of the configured trigger conditions are true.						
OR	Data capture starts (stops) when one of the configured trigger conditions is true.											
AND	Data capture starts (stops) when all of the configured trigger conditions are true.											
14	Detection methods	Sets the detection method of a trigger. <table border="1"> <tr> <td>Level</td> <td>Each condition is Level operation.</td> </tr> <tr> <td>Edge</td> <td>Each condition is Edge operation.</td> </tr> </table>	Level	Each condition is Level operation.	Edge	Each condition is Edge operation.						
Level	Each condition is Level operation.											
Edge	Each condition is Edge operation.											

Trigger Level Settings Screen

This screen is used to make the level settings to detect a trigger.
To make the settings, you input numerical values directly or use a cursor.

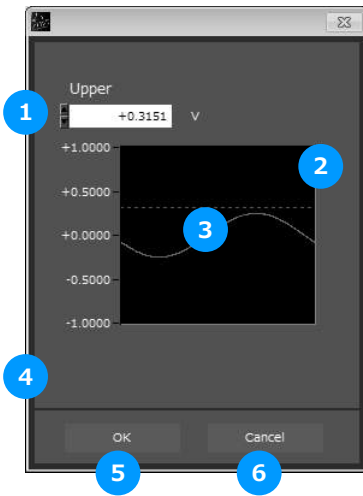

No.	Name	Description
1	Upper limit value input	Inputs the upper limit value.
2	Cursor selection range	Specified with the cursors on the top and bottom.
3	Input waveform	Displays the input waveform.
4	Lower limit value input	Inputs the lower limit value.
5	OK	Confirms the setting.
6	Cancel	Closes the screen without setting.

Level Detection and Edge Detection

To detect a trigger, you can select level detection or edge detection.

- **Level Detection:**

In the level detection, a trigger is detected when an input signal is above/below the specified level.

- **Edge Detection:**

In the edge detection, a trigger is detected when an input signal is above/below the specified level.

Even if an input signal reached the detection level before, a trigger is not detected unless it reaches the level again after it is outside.

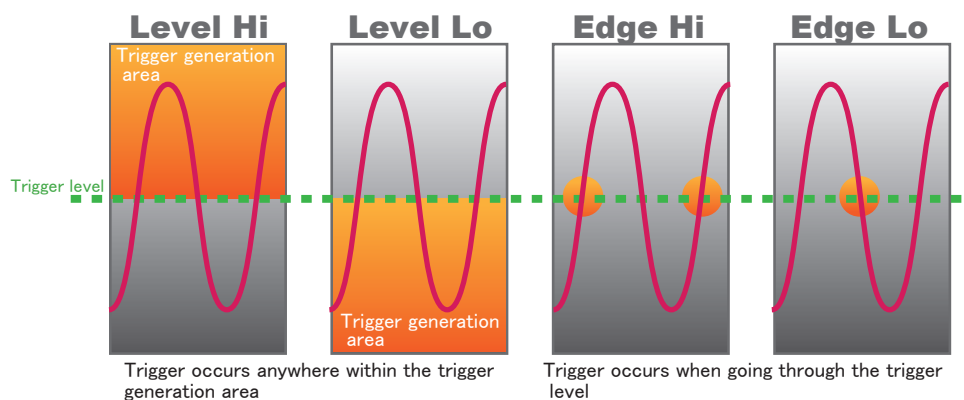

Alarm Condition

The alarm level settings for each input are made at this screen.

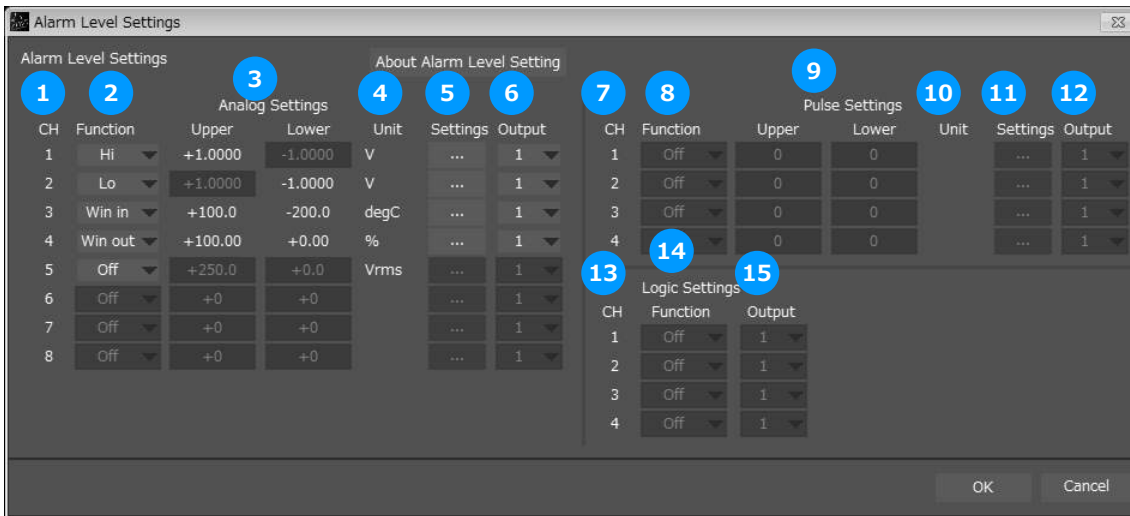

No.	Name	Description										
1	CH	The channel numbers are displayed.										
2	Function	Select the alarm level detection mode. <table border="1" data-bbox="523 994 1401 1317"> <tr> <td>Off</td> <td>Disabled.</td> </tr> <tr> <td>Hi</td> <td>An alarm is generated if the input signal is above the specified level.</td> </tr> <tr> <td>Lo</td> <td>An alarm is generated if the input signal is below the specified level.</td> </tr> <tr> <td>WinIn</td> <td>An alarm is generated if the input signal comes between the specified levels.</td> </tr> <tr> <td>WinOut</td> <td>An alarm is generated if the input signal goes outside the specified levels.</td> </tr> </table>	Off	Disabled.	Hi	An alarm is generated if the input signal is above the specified level.	Lo	An alarm is generated if the input signal is below the specified level.	WinIn	An alarm is generated if the input signal comes between the specified levels.	WinOut	An alarm is generated if the input signal goes outside the specified levels.
Off	Disabled.											
Hi	An alarm is generated if the input signal is above the specified level.											
Lo	An alarm is generated if the input signal is below the specified level.											
WinIn	An alarm is generated if the input signal comes between the specified levels.											
WinOut	An alarm is generated if the input signal goes outside the specified levels.											
3	Upper/Lower	The level settings are displayed here.										
4	Unit	The unit is displayed here.										
5	Setting	Click this button to make the level settings.										
6	Output	Set the terminal that outputs an alarm. It is selected out of the device's four alarm output terminals. OR is applied to output of the terminal for each channel.										
7	Pulse CH	The channel numbers for pulses are displayed here.										
8	Pulse Function	Use this button to select the pulse level detection mode. (Same as Analog)										
9	Pulse Upper/Lower	The level settings are displayed here.										
10	Pulse Unit	The unit is displayed here.										
11	Pulse Settings	Click this button to make the pulse settings.										
12	Pulse Output	Set the terminal that outputs an alarm. It is selected out of the device's four alarm output terminals. OR is applied to output of the terminal for each channel.										
13	Logic CH	The channel numbers for logics are displayed here.										
14	Logic Function	Use this button to select the logic setting. <table border="1" data-bbox="523 1890 1401 2011"> <tr> <td>X</td> <td>Disabled</td> </tr> <tr> <td>H</td> <td>Detection is performed when the signal is rising.</td> </tr> <tr> <td>L</td> <td>Detection is performed when the signal is falling.</td> </tr> </table>	X	Disabled	H	Detection is performed when the signal is rising.	L	Detection is performed when the signal is falling.				
X	Disabled											
H	Detection is performed when the signal is rising.											
L	Detection is performed when the signal is falling.											

No.	Name	Description
15	Logic Output	Set the terminal that outputs an alarm. It is selected out of the device's four alarm output terminals. OR is applied to output of the terminal for each channel.

Alarm Level Settings Screen

Configures the level at which to generate an alarm.
The setting will be similar to the trigger level.

Alarm Mail Settings

Can send an email during alarm operation, or send a periodic email.
(Environment required for sending of emails)

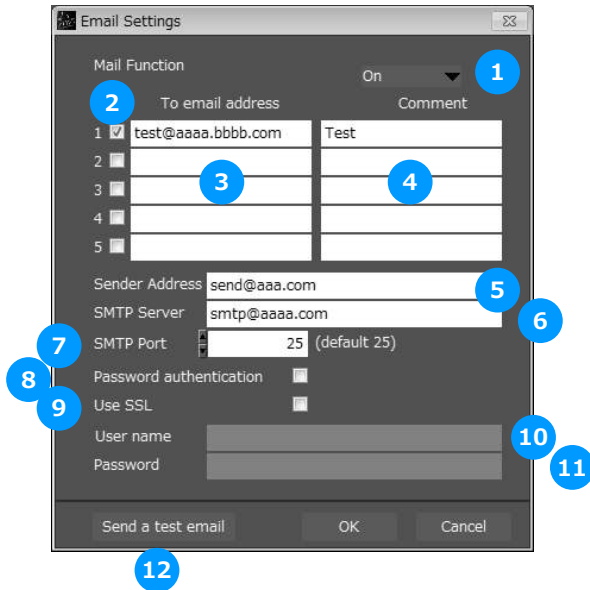

No.	Name	Description
1	Send Email when Alarm is Generated	Set to On in order to enable the sending of mails.
2	On/Off	Alarm mails can be configured for a maximum of 5 recipients.
3	Address(s)	Enter the email address.
4	Title	Enter the Title.
5	Sender address	Enter the sender email address.
6	SMTP Server	Enter the SMTP server name or address.
7	SMTP Port	Set SMTP server sending port. When not using SSL, 25, when using SSL, 587 or 465
8	Password authentication	Check to use password authentication.
9	Use SSL	Check if you use SSL.
10	User	Input authorized user name for SMTP server
11	Password	Input authorized password for SMTP server
12	Send Test Mail	Send test mail to email address.

EX) When sending to Gmail (as of Oct 2017)

Name	Description
SMTP server	smtp@gmail.com
SMTP port	587
Password authentication	Check
Use SSL	Check
User	*****@gmail.com
Password	Your password

Other Settings

This screen is used to make various other settings and to display information.

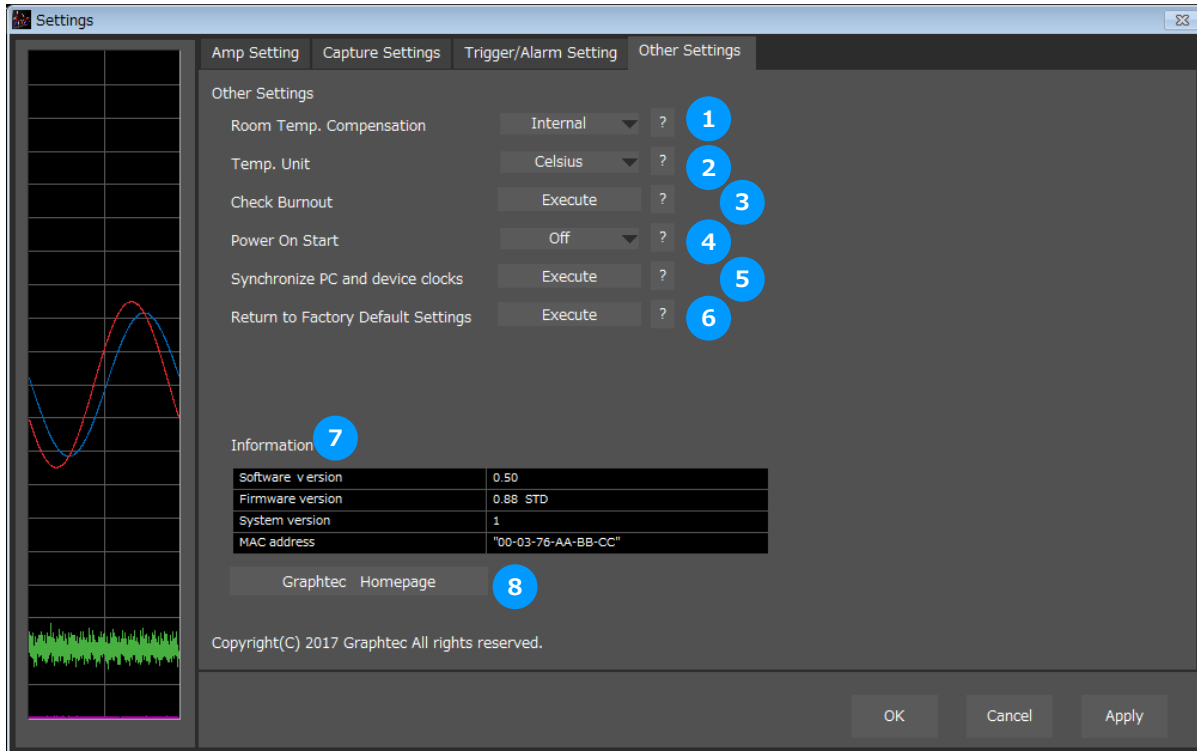

No.	Name	Description								
1	Room Temp. Compensation	This parameter is used when thermocouples are used to perform temperature measurement. When using this device for room temperature compensation, select Internal.(Always select Internal for this setting.)								
2	Temp. Unit	The display unit can be switched between Celsius and Fahrenheit.								
3	Check burnout	Checks for broken wires of the thermocouple when a temperature is configured with GL980/GL2000.								
4	Power On Start	Data capture starts automatically as soon as the power to the device is turned on. This setting can only be specified for data capture to the device. If On has been selected, select "Save the settings to the device" when exiting this software.								
5	Synchronize PC and device clocks	Click this button to send the PC clock to the GL.								
6	Return to Factory Default Settings	Return the settings to the default values.								
7	Information	Displays the information of the software and the main unit. <table border="1" style="width: 100%; border-collapse: collapse;"> <tr> <td style="width: 20%;">Software Version</td> <td>Displays the version of this software.</td> </tr> <tr> <td>Firmware Version</td> <td>Displays the main unit firmware version of GL980/GL2000.</td> </tr> <tr> <td>System Version</td> <td>Displays the main unit system version of GL980/GL2000.</td> </tr> <tr> <td>MAC Address</td> <td>Displays the MAC address of GL980/GL2000.</td> </tr> </table>	Software Version	Displays the version of this software.	Firmware Version	Displays the main unit firmware version of GL980/GL2000.	System Version	Displays the main unit system version of GL980/GL2000.	MAC Address	Displays the MAC address of GL980/GL2000.
Software Version	Displays the version of this software.									
Firmware Version	Displays the main unit firmware version of GL980/GL2000.									
System Version	Displays the main unit system version of GL980/GL2000.									
MAC Address	Displays the MAC address of GL980/GL2000.									
8	Graphtec Web site	Click this button to access the Graphtec web site.								

12. Data Capture

This chapter describes the basic operating procedure.

The operating procedure starts with the software and the device in the connected status. For the connection procedure,

refer to Chapter 9. Connection.

The settings that are not addressed in the following sections are the factory default settings.

Settings

Description

1	Settings related to AMP	CH1: Input: Voltage, Range: 1V, Filter: Off, Scaling: Off CH2: Input: Temperature, Range: TC-T, Filter: Off, Scaling: Off Set to other channels to Off.
2	Settings related to data capture	Sampling Interval: 100us Data Points: 1,000,000 Device Capture Destination: Internal RAM PC Capture Format: Binary Data

After connecting to the device, press the "Settings" button on the main screen.

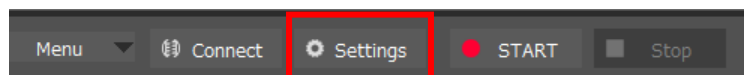

Settings related to AMP

The settings for CH1 and CH2 are made according to the setting options. Set other channels to "Off".

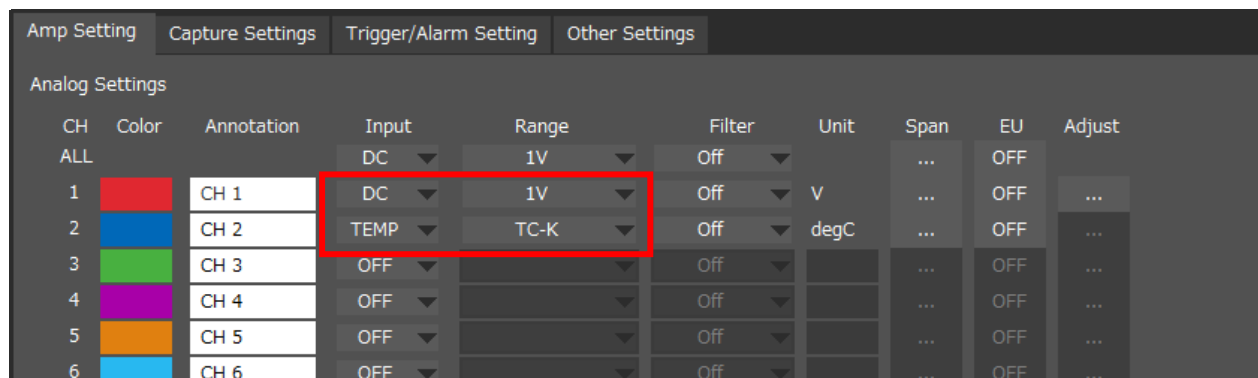

Settings related to data capture

The settings related to data capture are made according to the setting options.

- Select the "Capture Settings" tab.
- Set "Sampling Interval" to 100us.
- Set "Data Points" to 1,000,000.
- Set "Destination" of "Device Capture Settings" to "Internal RAM".
- Set "Name Type" of "Device Capture Settings" to "Auto".
- Set "Data Type" of "PC Capture Settings" to "Binary Data(GBD)".

The screenshot shows the 'Capture Settings' tab in a software interface. The settings are organized into several sections:

- Device save settings:** 'Sampling interval' is set to 100uS, and 'Destination' is set to Internal RAM. Both dropdown menus are highlighted with red boxes.
- Internal RAM save settings:** 'Ring Capt. Pts.' is set to 1000000, highlighted with a red box. Other options include 'Memory block division' (No Divisions), 'Overwrite mode' (Off), 'Internal RAM clear' (Execute), and 'Allowable Time' (0day 00H 01M 39.9999S).
- Device file save settings:** 'Name Type' is set to Auto, 'Data Type' is set to GBD, 'File Path' is MEM, 'Ring/Relay Capture' is Off, and 'Capture Space' is 2.3GB.
- PC Capture Settings:** 'Name Type' is set to Auto, 'Data Type' is set to GBD, and 'File Path' is C:\Users\m-arisuda.in0913\Doc ... \Data\.
- Other Settings:** 'Configure to export to direct Excel file' is set to Off.

In the above settings, 1,000,000 data points are captured to the internal RAM and to the PC at the sampling interval 100us.

Start

You can press the "Start" button to start data capture.

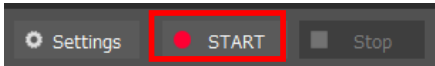

Behaviors When Using the Internal RAM

When the device data capture destination is set to the internal RAM, high-speed data capture can be performed at the sampling interval 1 μ s or above.

On this software, the device is capturing data at high speed while exporting it to the PC.

Even after the device ends data capture, all of the data will be exported.

Behaviors during Data Capture

You can use the "Scroll" button to switch between the scrolling and the data replay operations.

While the "Scroll" button turns green, the scrolling operation can be performed.

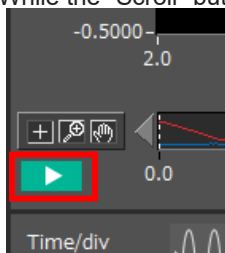

During the scrolling operation, the newest data exported from the device is displayed.

During the data replay operation, data that has been exported from the device can be checked, and cursor operations can be performed.

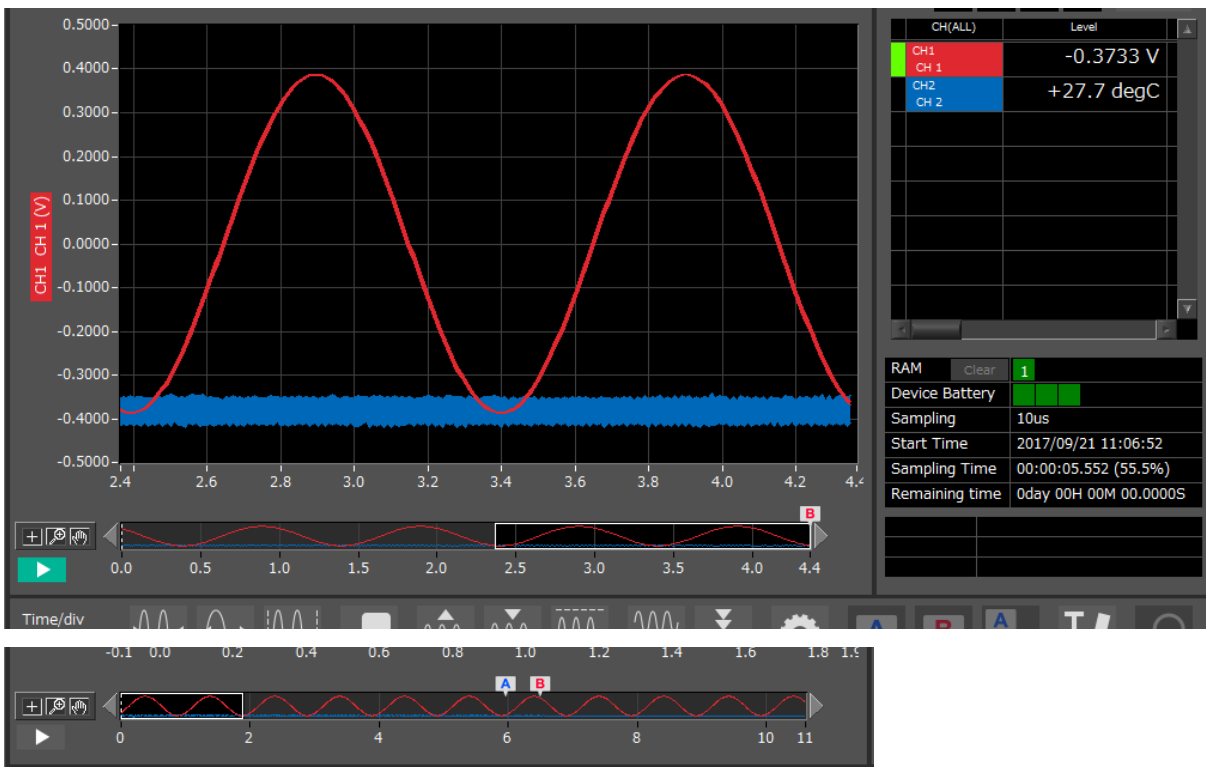

Stop

Recording will automatically stop when the 1,000,000 points of data configured with the recording settings have been recorded by the main unit.

If the transfer of all data has not been completed with the application, the data will be transferred until it is all completed.

The transfer of all data will end, the data will be saved on the PC side, and the system will transition to the free-running state.

When you want to stop data capture manually during data capture, use the "Stop" button to stop it.

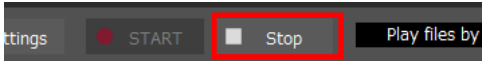

Recording data can be played back from the file history.

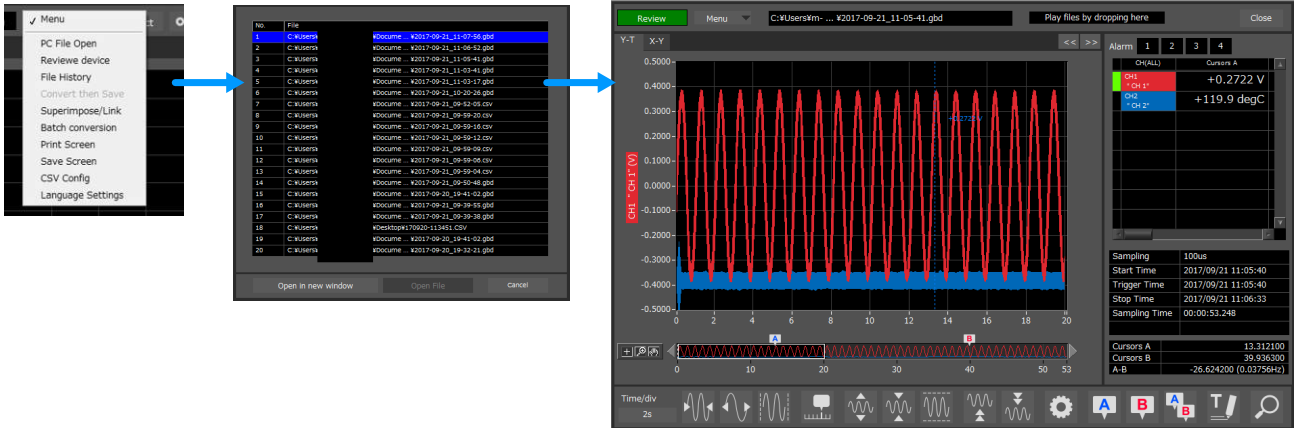

13. Replaying Data

Data that has been captured to the PC and the device's internal flash memory or USB memory can be replayed. Data captured in this software or captured to the device can be replayed. Data can be replayed as binary data (GBD) or text data (CSV). Here, we will replay binary data captured to the PC and perform basic operations.

Replaying File

From "Menu" on the main window, select "PC File Open"

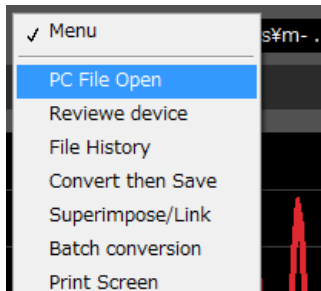

The screen to select a file opens. Select a file from the location where it is saved, and press the "Select".

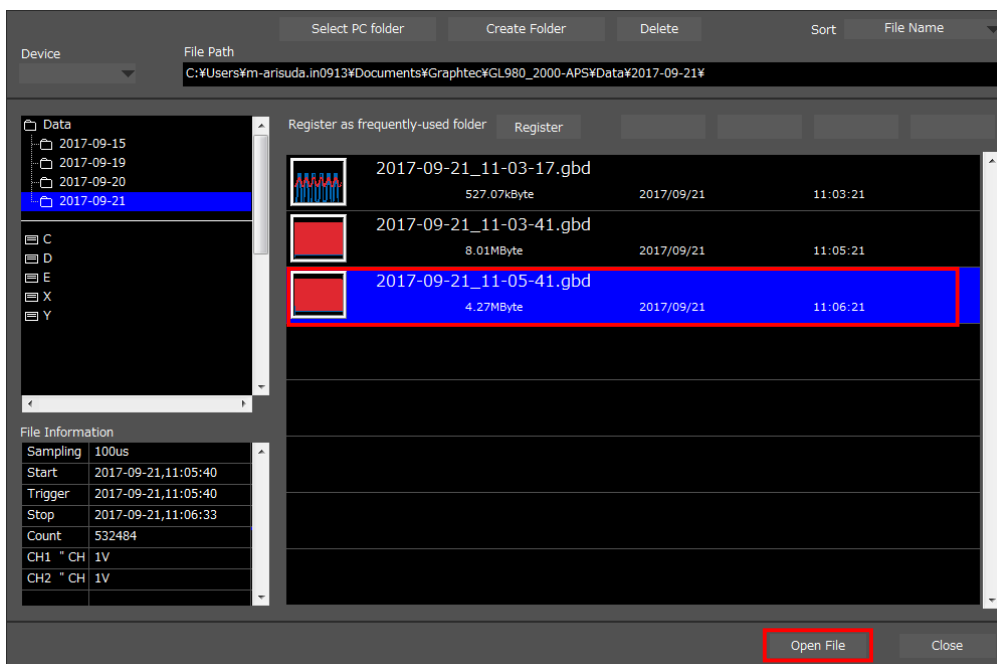

The selected file is read, and the waveforms are displayed.

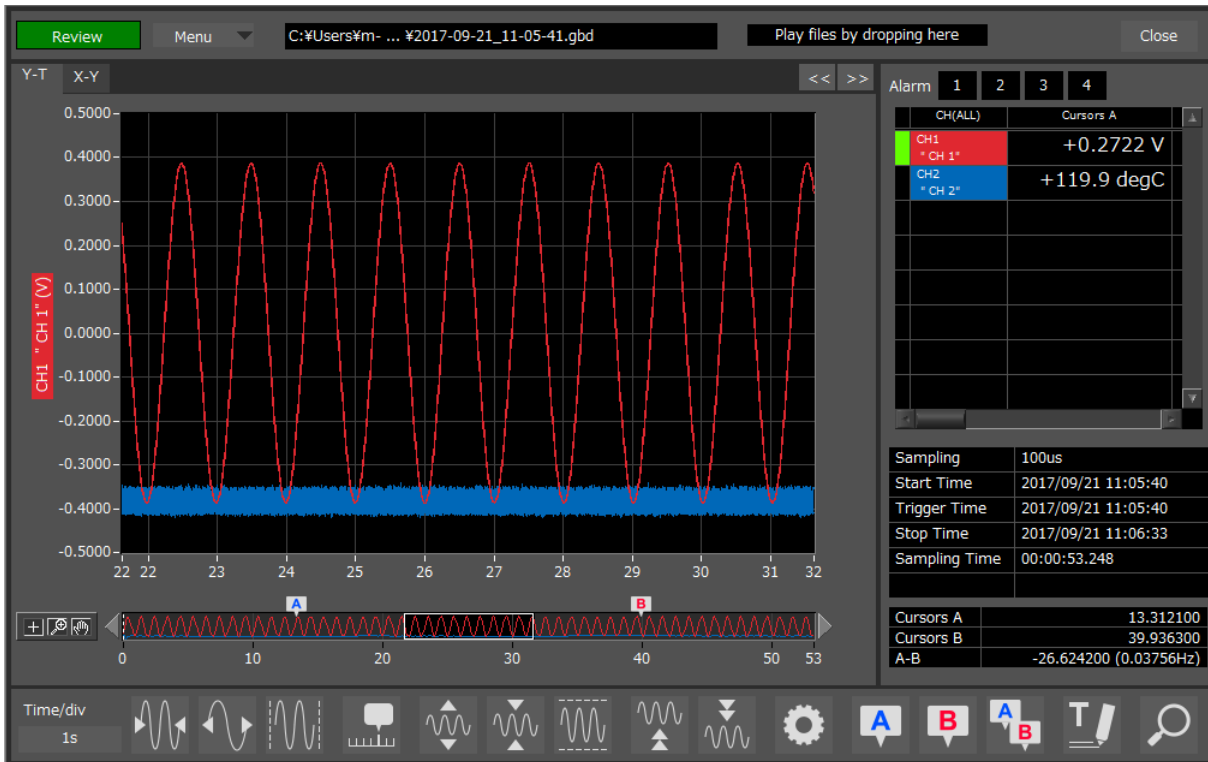

Cursor Operations

During replay, two cursors A and B are provided and can be moved to any position in the waveforms. You can drag the cursors on the waveforms to move them. Also, you can use the icon of the scroll bar to move them.

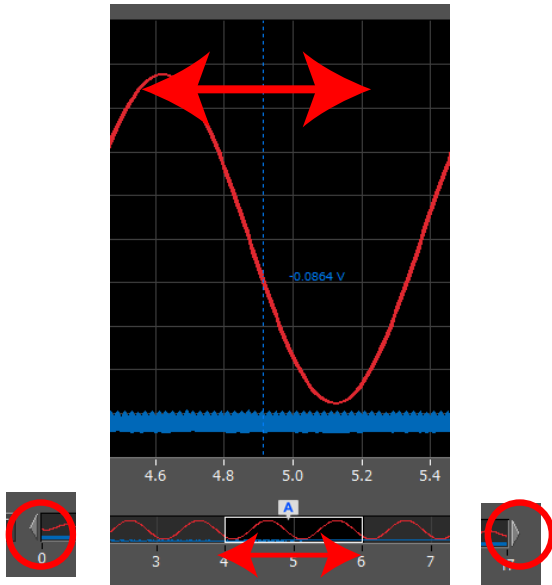

Checking Cursor Information

The level values and time for the cursors A and B can be checked. These items can be confirmed by displaying the statistics.

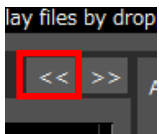

The "Cursor Info." opens. The level values and time for the cursors A and B can be checked. The cursors can be moved in this status.

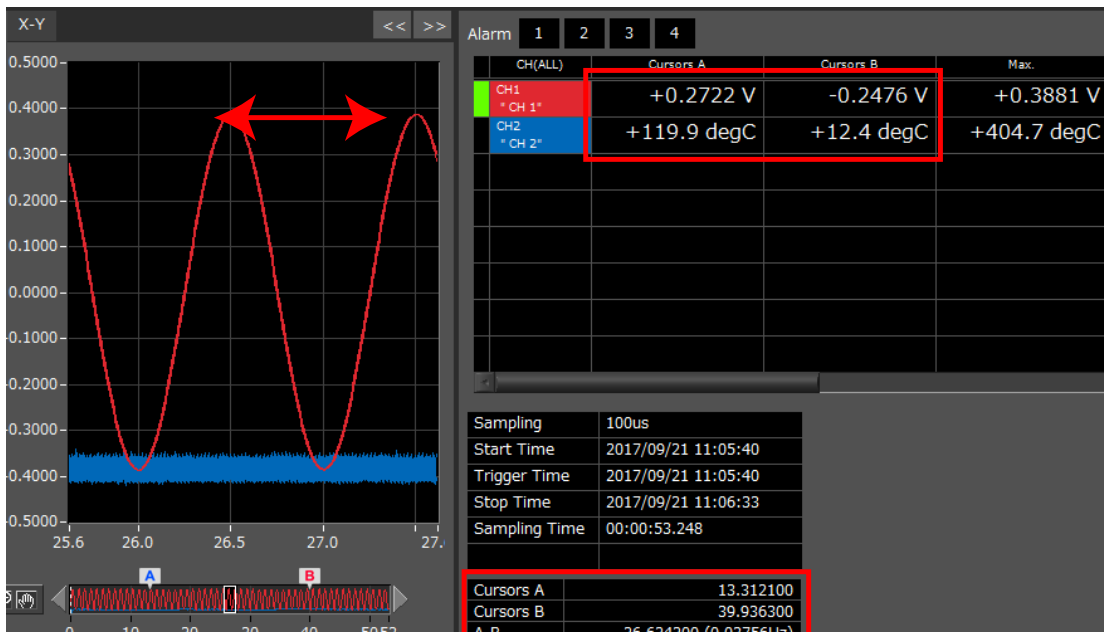

Input Comments

A comment can be input at the position above the desired channel of cursor A.
The input comment will be saved even after a file is closed. Next time the file is open, it is displayed in the same location.
(Only when the data is captured to the PC).

Select the "Comment" icon.



Here, we will input a comment for a "confirmation point" on the waveform of CH1.
After entering a string of letters, press the "Input" button.

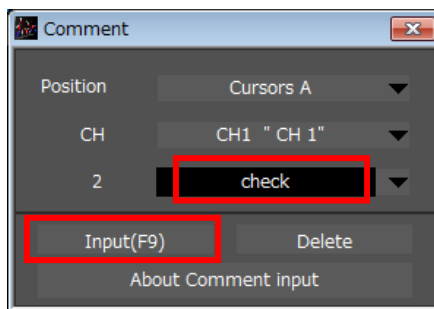

Now, the comment is input.

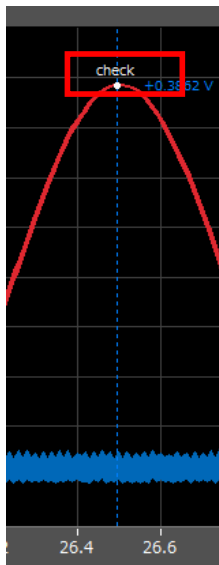

Data Search

Search is performed to check the location where data is above/below the specified value. Then, a cursor and waveforms are moved to the location.

Here, we will search for a rising signal and the location above qV for CH1.

Select "Move Search" icon.

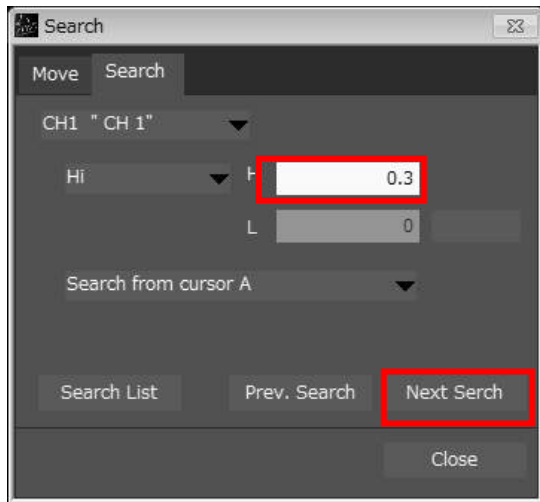

1. Set CH to CH1.
2. Set the search condition to "Hi" (rising signal).
3. Open the level setting screen.
4. Input 1.0V.
5. Press the "OK".
6. Press the "Next Search" to search the current cursor in the forward direction.

The location above 1.0 V is located, and cursor A and the waveform are moved.

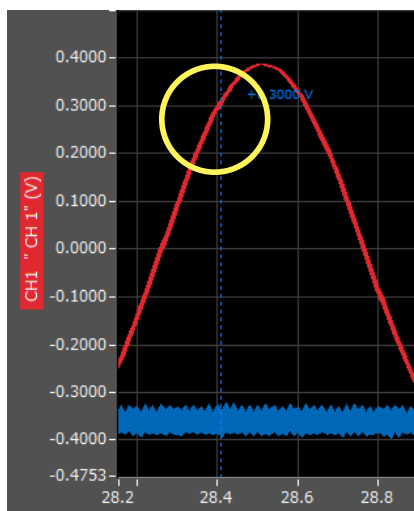

GRAPHTEC

- Specifications are subject to change without notice.

GL900/GL2000-APS Application Software User's Manual
APS (GL900_GL2000) -UM-101
Oct 1, 2017
GRAPHTEC CORPORATION