

## Interface 9870 Quick Start Guide

### Set Up:

Start by inserting the sensor wires into the Sensor Signal Input Connector. The Signal Input Terminals are indicated in **(Figure 1)** below:

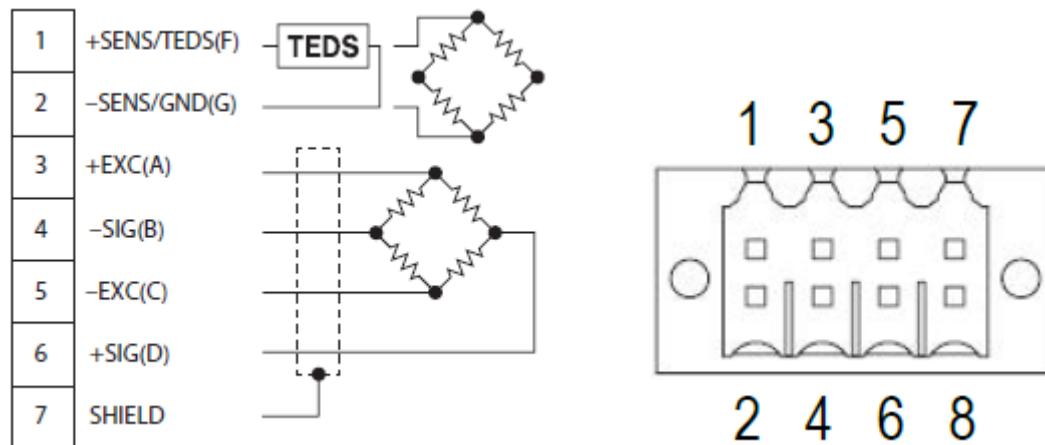

**(Figure 1)**

Insert a flat bladed micro screwdriver into the square hole above or below the round wire insertion hole as shown in **(Figure 2)**. This will open the metal cover over the round wire insertion hole. After you have inserted the wire, remove the flat bladed micro screwdriver to secure the wire in its position. Once all of the necessary wires have been attached to the Signal Input Connector, plug the connector into the 9870 indicator and secure it with the screws located on each side.

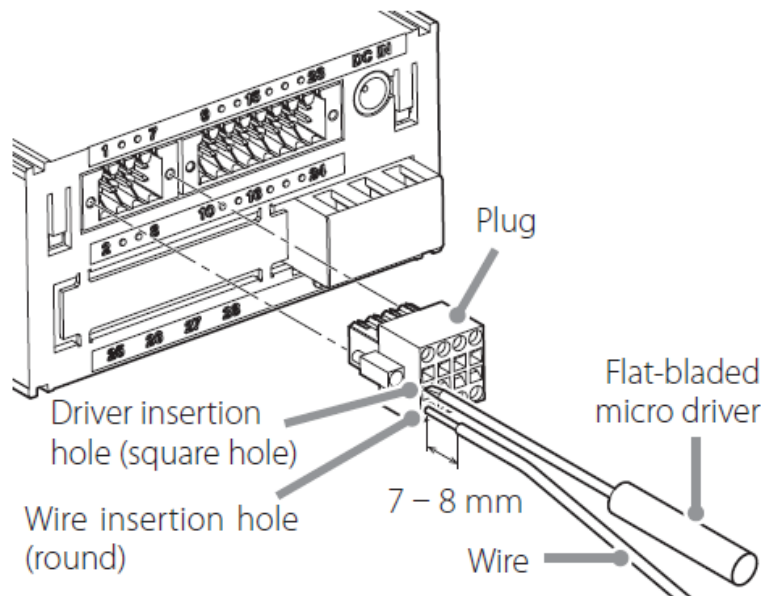

**(Figure2)**

Plug the supplied DC power adaptor into the 9870 DC input, then plug the DC power adaptor into a standard wall socket. You will see the 9870 Standard Home Screen appear on the display.

## Remote Sense / TEDS:

If you are using a six-wire configuration TEDS enabled load cell or SENS enabled loadcell, you will need to adjust the Remote Sense/TEDS parameter. If you are using a four-wire configuration load cell without TEDS or SENS, skip ahead to the **Calibration** section.

To begin Remote Sense / TEDS Enabling from the Standard Home Screen, press the **Function** button. This will bring you to the Function Menu:

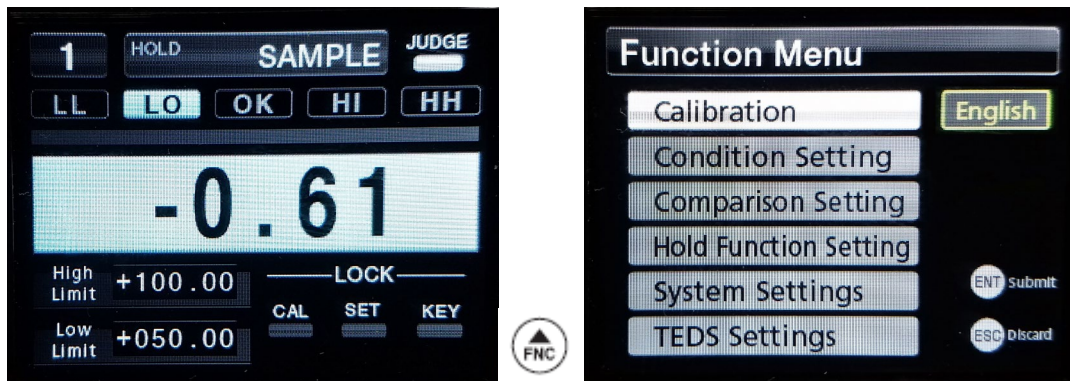

From the Function Menu, use the Arrow buttons to highlight Calibration, then press the **Enter** button. This will bring you to the Calibration Menu:

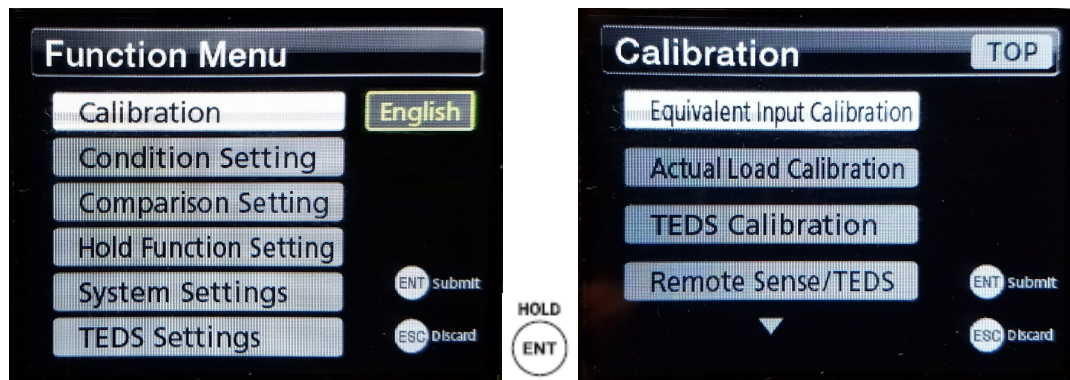

From the Calibration Menu use the Arrow buttons to highlight Remote Sense / TEDS, then press the **Enter** button. This will take you to the Remote Sense / TEDS Menu:

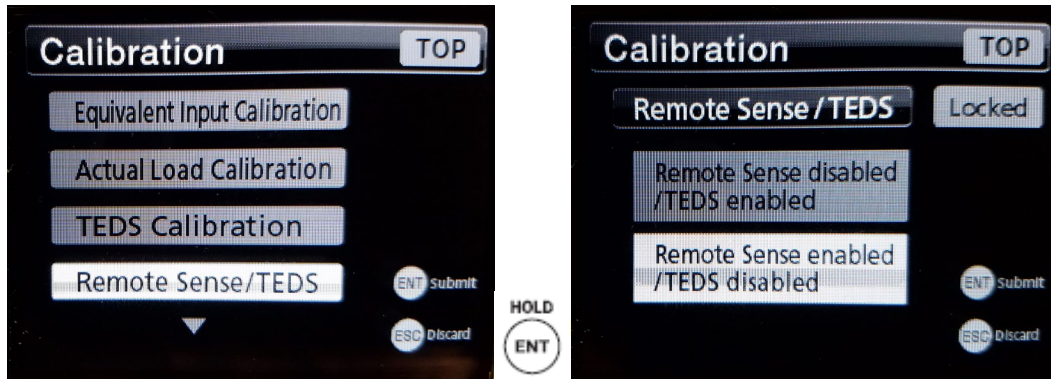

At the Remote Sense / TEDS Menu, use the Arrow buttons to select the appropriate option depending on the type of load cell you are using. For this example, we will choose SENS enabled. If you are using a TEDS enabled load cell, then choose TEDS enabled. Once you have made a selection, press the **Enter** button. The option you have selected will be highlighted in Green. Press the **Enter** button again to confirm your selection:

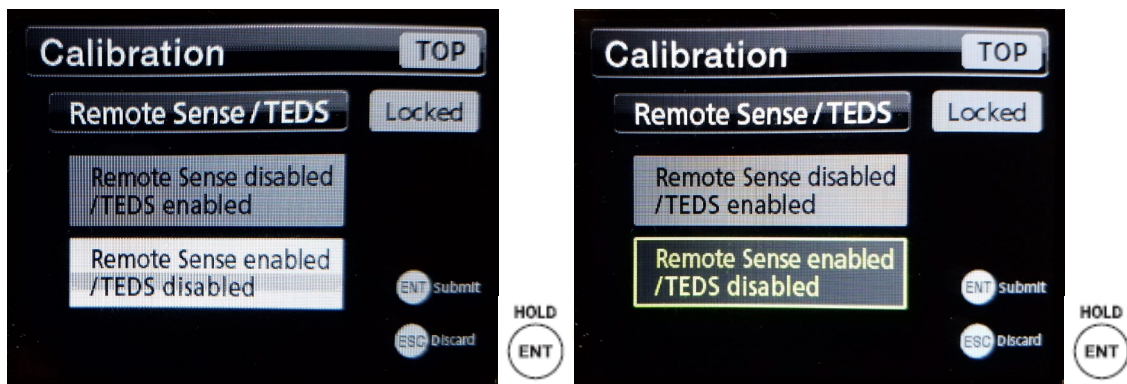

This will bring you back to the calibration menu, the Remote Sense / TEDS parameter has been set. Press the **Escape** button two times to return to the Standard Home Screen:

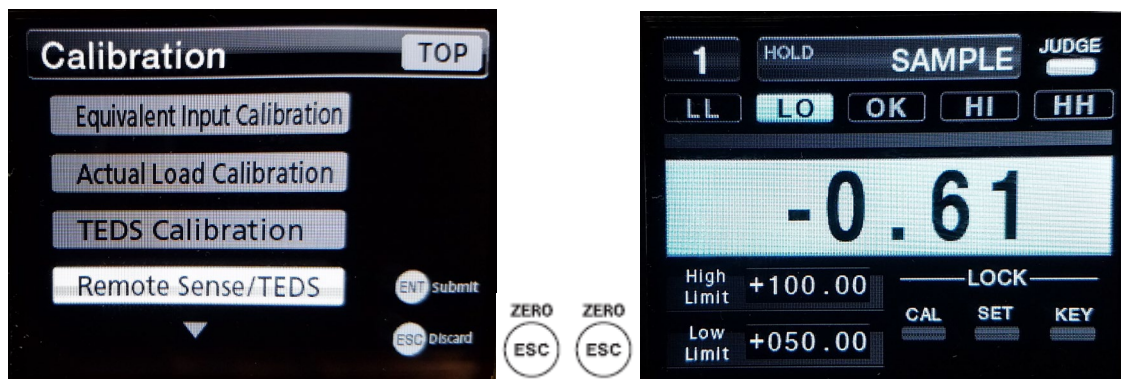

If you are using a TEDS enabled load cell, skip ahead to the **Digital Zero** section. Otherwise, proceed with **Calibration**.

### Calibration:

From the Standard Home Screen, press the **Function** button. This will bring you to the Function Menu:

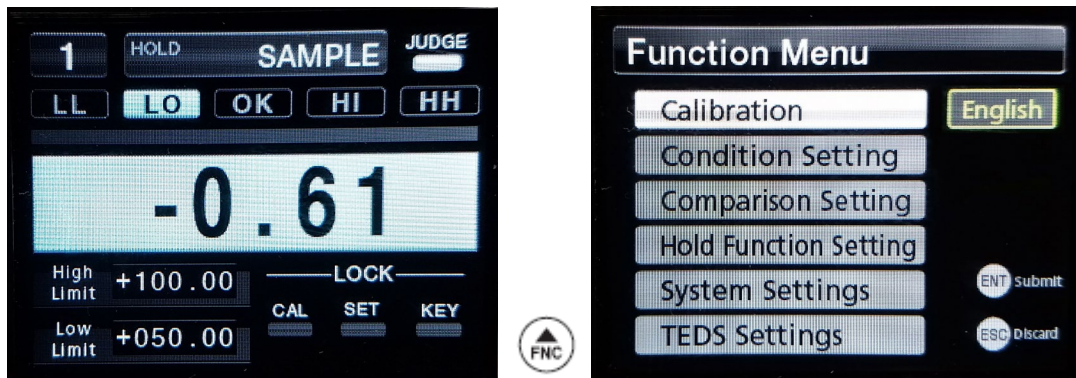

From the Function Menu use the Arrow buttons to highlight Calibration, then press the **Enter** button:

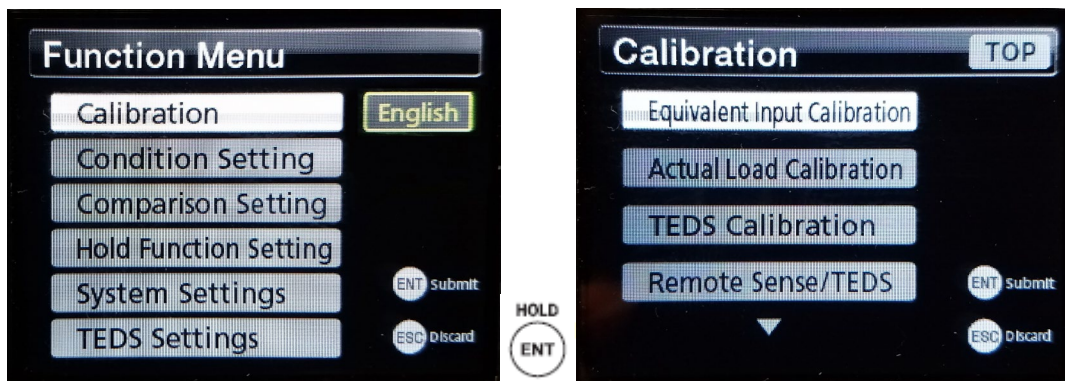

From the Calibration Menu use the Arrow buttons to highlight Equivalent Input Calibration, then press the **Enter** button:

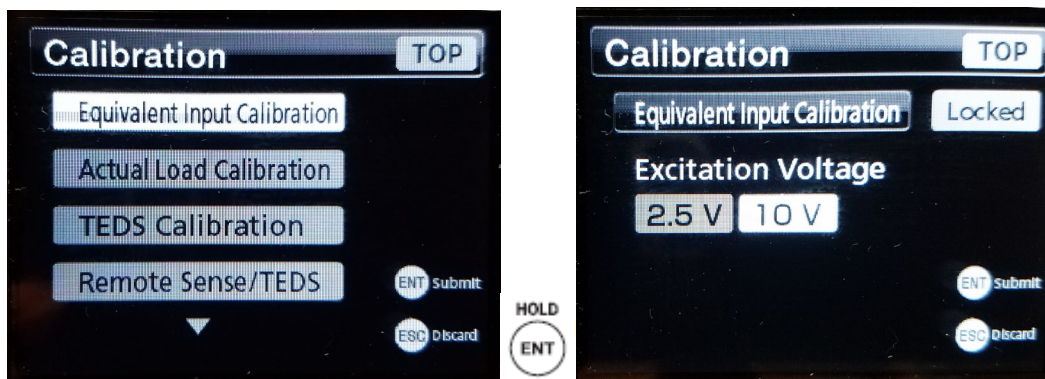

Use the Arrow buttons to select the Excitation Voltage indicated on the sensors corresponding Calibration Certification, then press the **Enter** button. The selected Excitation Voltage will be highlighted Green. Press the **Enter** button again to confirm the selected Excitation Voltage:



This will bring you to the Rated Output and Rated Capacity parameters. The Rated Output will be highlighted in White. Use the Arrow buttons to select the Rated Output indicated on the sensors corresponding Calibration Certification, then press the **Enter** button:



The Rated Capacity will now be highlighted in White. Use the Arrow buttons to select the Rated Capacity indicated on the sensors corresponding Calibration Certification, then press the **Enter** button:



The Rated Output and the Rated Capacity are now highlighted in Green. Press the **Enter** button again to confirm the Rated Output and Rated Capacity values:

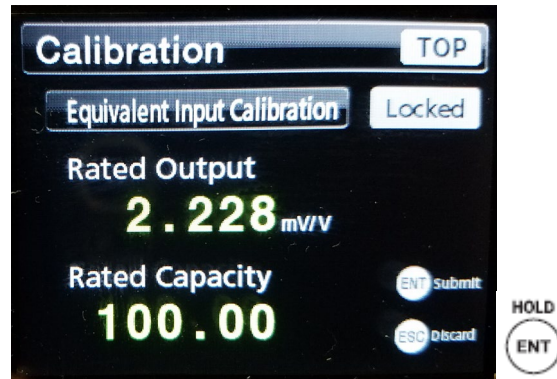

This will bring you to the Zero Balancing function. For the purpose of this Quick Start guide, it will not be necessary to execute the Zero Balancing function. For further information on the Zero Balancing function, see (Page 37) of the Interface 9870 User Manual. To proceed, use the Arrow buttons to highlight Skip and then press the **Enter** button:

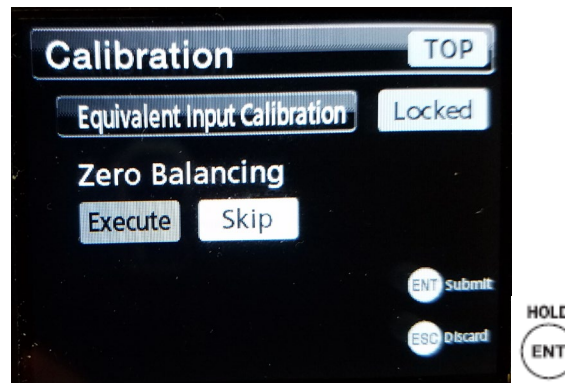

Next you will see the D/A Output Mode parameter. The Analog Output can be set to Voltage or Current depending on the requirements of the application. For this example, we will select Voltage. Use the Arrow buttons to highlight Voltage and then press the **Enter** button. Voltage will be highlighted in Green. Press the **Enter** button again to confirm the D/A Output Mode parameter:

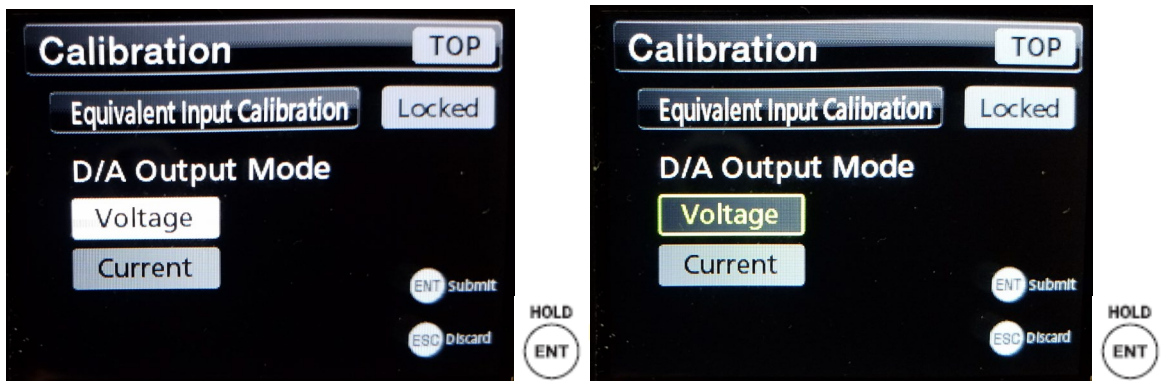

This will bring you to the D/A Max. Voltage parameter. For this example, we will set the D/A Max. Voltage to 10v. Use the Arrow buttons to input 10v, then press the **Enter** button. 10v will be highlighted in Green, press the **Enter** button again to confirm the D/A Max Voltage parameter:

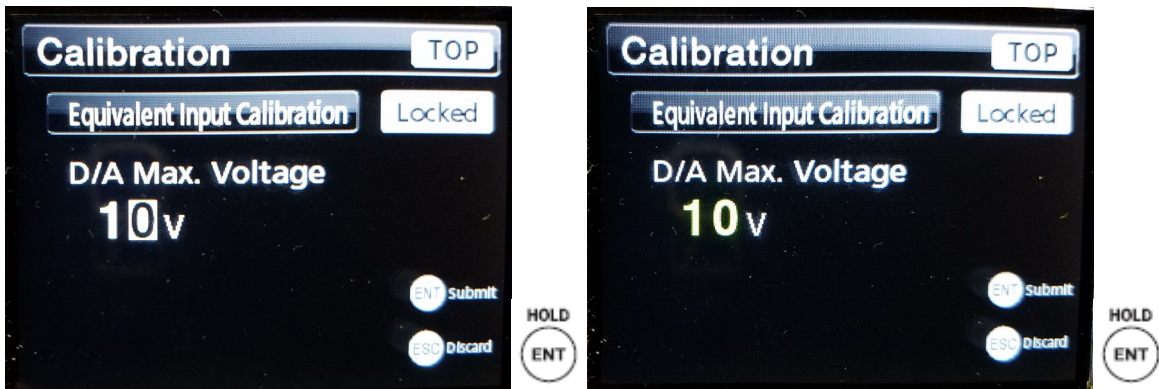

Next select the desired Engineering Units from the Select EU menu. Use the Arrow buttons to highlight the appropriate Engineering Units, then press the **Enter** button. The selection will be highlighted in Green, press the **Enter** button again to confirm the selected Engineering Units:

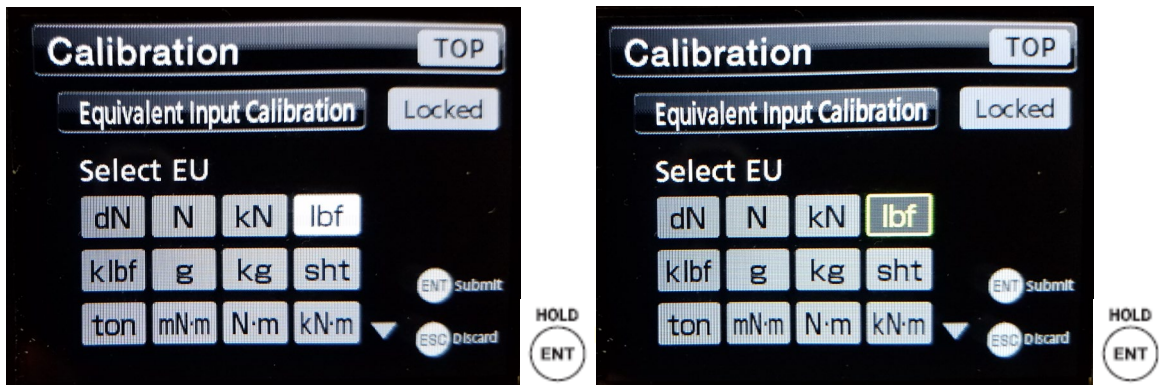

After you have confirmed the Engineering Units, you will see the Cal. Value Lock parameter. This can be used to lock the Calibration Value if necessary. For this example, it will not be necessary to lock the Calibration Value. Use the Arrow buttons to highlight OFF and then press the **Enter** button. The OFF selection will be highlighted in Green. Press the **Enter** button again to confirm the selection:

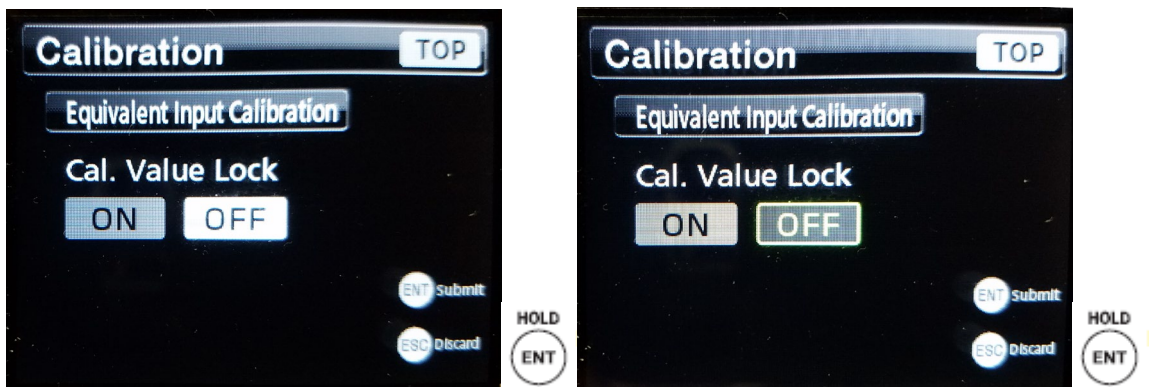

This will bring you back to the Function Menu. From the Function Menu, press the **Escape** button to return to the Standard Home Screen:

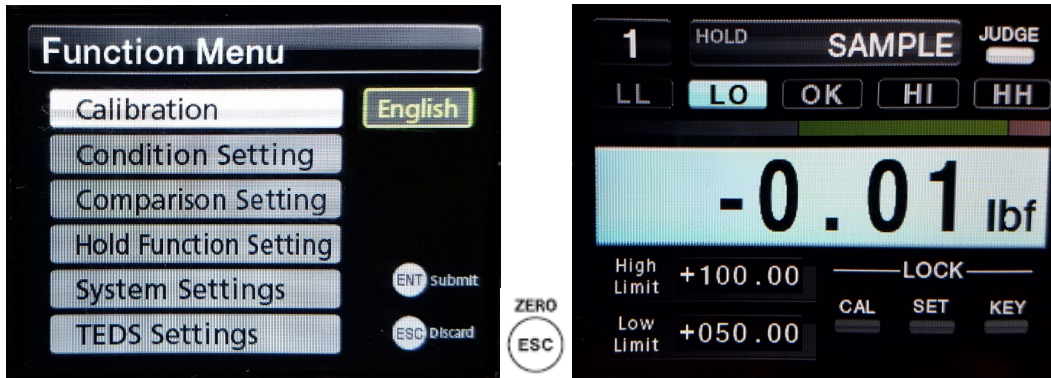

The load cell is now calibrated, proceed to **Digital Zero**.

### Digital Zero:

To set Zero from the Standard Home Screen, Hold down the **Zero** Button. When the Interface 9870 has completed setting Zero, the Zero value will be displayed on the Standard Home Screen:

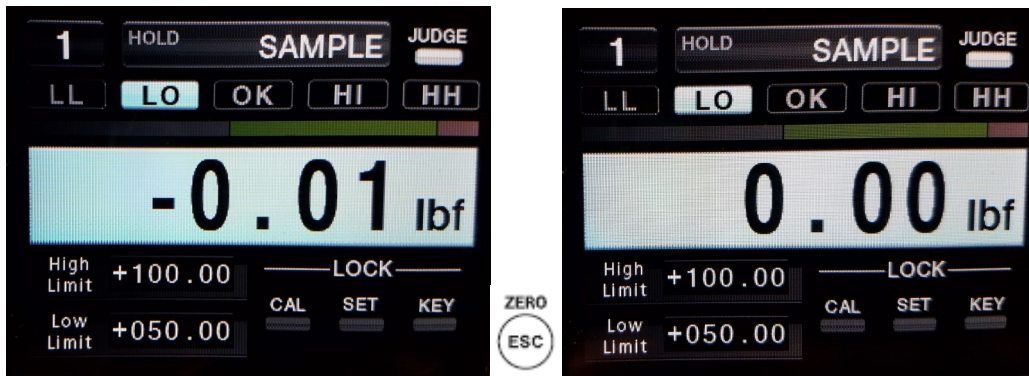

The Interface 9870 is now is now calibrated and ready to use. For more detailed information regarding the full range options and functions available within the Interface 9870, please refer to the Interface 9870 User Manual.